

**BREMICK™**

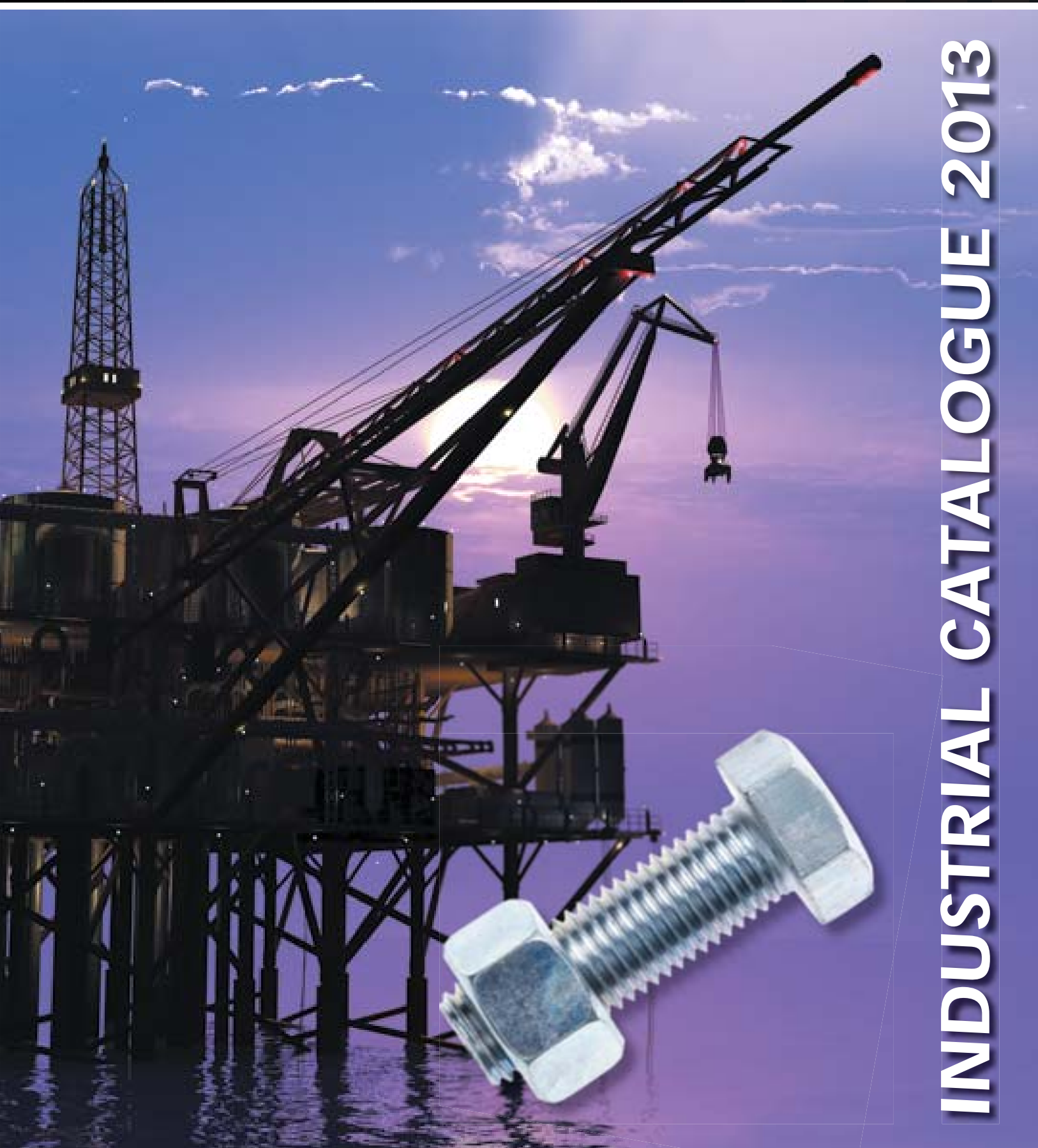

**INDUSTRIAL CATALOGUE 2013**

[www.bremick.com.au](http://www.bremick.com.au)



## Bremick Values

### **Trust**

We take pride in the quality of our products and services through design, development, manufacturing, quality systems, logistics and after sales service to our extensive network of authorised distributors.

### **Innovation**

Bremick product development teams are continually monitoring industry trends and end user needs resulting in a constant flow of innovation, bringing real value to consumers and distributors alike.

### **Quality**

Our quality systems ensure strict conformance to national and international standards through rigorous test and inspection procedures of stud materials throughout our manufacturing processes at the purpose built Bremick NATA Accredited laboratory in Sydney. In addition verification testing of our stud bolt materials is undertaken at independent 3rd party NATA testing laboratories.

### **Reliability**

Bremick has been the leading Australian fastener supplier for over 50 years with 11 factory warehouses across the Pacific Region, all of which are linked by a centralised computer system, ensuring efficient service and on time delivery to all of our valued customers.

## CONTENTS

PAGE

### MILD STEEL

BSW Bolts & Nuts	3
BSW Set Screws	6
Metric 4.6 Bolts & Nuts	9
Metric 4.6 Set Screws	27
BSW Cup Head Bolts & Nuts	29
Metric Cup Head Bolts & Nuts	31
Coach Screws	39

### STRUCTURAL

Metric Bolt, Nut & Washer Assemblies	44
Metric Structural Nuts	48
Metric Structural Washers	49
Metric Load Indicating Washers	50

### HIGH TENSILE

UNC Grade 5 Bolts & Nuts	51
UNC Grade 8 Bolts & Nuts	55
UNF Grade 5 Bolts & Nuts	68
UNF/UNS Grade 8 Bolts & Nuts	72
Metric Class 8.8 Bolts & Nuts	83
Metric Class 8.8 Set Screws	97

### THREADED ROD

BSW Mild Steel	99
UNC Mild Steel	101
UNF Mild Steel	101
Metric Class 4.6	102
Metric Class 8.8	105
Metric Hexagonal Coupling Nuts	106
Metric Square Washers	107

## Industrial List

### CONTENTS

### PAGE

#### NUTS

UNC Grade 5 Hexagonal Nuts	108
UNF Grade 5 Hexagonal Nuts	110
UNF Grade 8 Hexagonal Nuts	111
BSW Hexagonal Nuts	112
Metric Class 8 Hexagonal Nuts	113
Metric Class 5 Hexagonal Nuts	114
UNF Nylon Insert Lock Nuts	116
UNC Nylon Insert Lock Nuts	116
BSW Nylon Insert Lock Nuts	117
Metric Nylon Insert Lock Nuts	117

#### WASHERS

Metric & Imperial Flat Round Washers	118
Grade 8 Flat Round Washers	120

#### TECHNICAL DATA

Thread Chart	121
Bolt Standards	122
Fastener Grades & Markings	123
Washer Standards	124
Installation Guide for Load Indicating Washers	125

#### TRADING TERMS

Summary of Trading Terms	129
--------------------------	-----

# HEXAGON HEAD BOLTS & NUTS

**BSW AS 2451 - 1998**  
**ZINC PLATED**

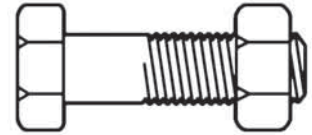

Diameter (Inches)	Length (Inches)	Product Code	Std. Pack
<b>1/4</b> <b>20 TPI</b>	3/4	B20WZ060751	150
	1	B20WZ061001	
	1.1/4	B20WZ061251	
	1.1/2	B20WZ061501	
	1.3/4	B20WZ061751	
	2	B20WZ062001	
	2.1/4	B20WZ062251	
	2.1/2	B20WZ062501	
	2.3/4	B20WZ062751	
	3	B20WZ063001	
	3.1/2	B20WZ063501	
	4	B20WZ064001	
	4.1/2	B20WZ064501	100
	5	B20WZ065001	
	5.1/2	B20WZ065501	
	6	B20WZ066001	
<b>5/16</b> <b>18 TPI</b>	3/4	B20WZ080751	150
	1	B20WZ081001	
	1.1/4	B20WZ081251	
	1.1/2	B20WZ081501	
	1.3/4	B20WZ081751	
	2	B20WZ082001	
	2.1/4	B20WZ082251	
	2.1/2	B20WZ082501	
	2.3/4	B20WZ082751	100
	3	B20WZ083001	
	3.1/2	B20WZ083501	
	4	B20WZ084001	
	4.1/2	B20WZ084501	
	5	B20WZ085001	
	5.1/2	B20WZ085501	
	6	B20WZ086001	

CONTINUED OVER PAGE ►

MILD STEEL - BSW HEX

**BREMICK**<sup>TM</sup>

## HEXAGON HEAD BOLTS & NUTS

**BSW AS 2451 - 1998**  
**ZINC PLATED (CONTINUED)**

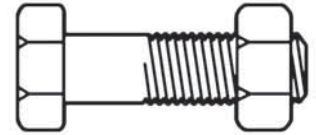

Diameter (Inches)	Length (Inches)	Product Code	Std. Pack
<b>3/8</b>  <b>16 TPI</b>	3/4	B20WZ100751	150
	1	B20WZ101001	
	1.1/4	B20WZ101251	
	1.1/2	B20WZ101501	
	1.3/4	B20WZ101751	
	2	B20WZ102001	100
	2.1/4	B20WZ102251	
	2.1/2	B20WZ102501	
	2.3/4	B20WZ102751	
	3	B20WZ103001	
	3.1/2	B20WZ103501	50
	4	B20WZ104001	
	4.1/2	B20WZ104501	
	5	B20WZ105001	
	5.1/2	B20WZ105501	
	6	B20WZ106001	
<b>1/2</b>  <b>12 TPI</b>	1	B20WZ121001	25
	1.1/4	B20WZ121251	
	1.1/2	B20WZ121501	
	1.3/4	B20WZ121751	
	2	B20WZ122001	
	2.1/4	B20WZ122251	
	2.1/2	B20WZ122501	
	3	B20WZ123001	
	3.1/2	B20WZ123501	
	4	B20WZ124001	
	4.1/2	B20WZ124501	
	5	B20WZ125001	
5.1/2	B20WZ125501		
6	B20WZ126001		

CONTINUED OVER PAGE ►

## HEXAGON HEAD BOLTS & NUTS

**BSW AS 2451 - 1998**  
**ZINC PLATED (CONTINUED)**

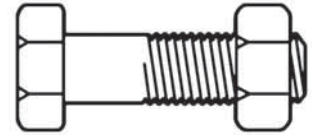

Diameter (Inches)	Length (Inches)	Product Code	Std. Pack
<b>5/8</b>	1	B20WZ161001	20
	1.1/4	B20WZ161251	
	1.1/2	B20WZ161501	
	1.3/4	B20WZ161751	
	2	B20WZ162001	
	2.1/4	B20WZ162251	
	2.1/2	B20WZ162501	
	2.3/4	B20WZ162751	
	3	B20WZ163001	
	3.1/2	B20WZ163501	
	4	B20WZ164001	
	4.1/2	B20WZ164501	
	5	B20WZ165001	
	5.1/2	B20WZ165501	
	6	B20WZ166001	
	7	B20WZ167001	
	8	B20WZ168001	
<b>3/4</b>	1.1/4	B20WZ201251	20
	1.1/2	B20WZ201501	
	1.3/4	B20WZ201751	
	2	B20WZ202001	
	2.1/4	B20WZ202251	
	2.1/2	B20WZ202501	
	3	B20WZ203001	
	3.1/2	B20WZ203501	
	4	B20WZ204001	
	4.1/2	B20WZ204501	
	5	B20WZ205001	
	6	B20WZ206001	
	7	B20WZ207001	
8	B20WZ208001		

MILD STEEL - BSW HEX

**BREMICK**<sup>TM</sup>

## HEXAGON HEAD SET SCREWS

**BSW AS 2451 - 1998**  
**ZINC PLATED**

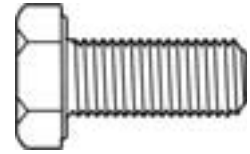

Diameter (Inches)	Length (Inches)	Product Code	Std. Pack
<b>1/4</b>  <b>20 TPI</b>	1/2	S20WZ060502	200
	3/4	S20WZ060752	
	1	S20WZ061002	
	1.1/4	S20WZ061252	
	1.1/2	S20WZ061502	
	2	S20WZ062002	
	2.1/2	S20WZ062502	150
	3	S20WZ063002	
<b>5/16</b>  <b>18 TPI</b>	1/2	S20WZ080502	200
	3/4	S20WZ080752	
	1	S20WZ081002	
	1.1/4	S20WZ081252	
	1.1/2	S20WZ081502	
	2	S20WZ082002	
	2.1/2	S20WZ082502	150
	3	S20WZ083002	
<b>3/8</b>  <b>16 TPI</b>	3/4	S20WZ100752	200
	1	S20WZ101002	
	1.1/4	S20WZ101252	
	1.1/2	S20WZ101502	
	2	S20WZ102002	150
	2.1/2	S20WZ102502	
	3	S20WZ103002	
	3.1/2	S20WZ103502	100
4	S20WZ104002		

CONTINUED OVER PAGE ►



## HEXAGON HEAD SET SCREWS

**BSW AS 2451 - 1998**  
**ZINC PLATED (CONTINUED)**

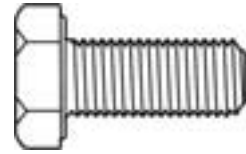

Diameter (Inches)	Length (Inches)	Product Code	Std. Pack
1/2 12 TPI	3/4	S20WZ120752	100
	1	S20WZ121002	
	1 1/4	S20WZ121252	
	1 1/2	S20WZ121502	
	2	S20WZ122002	75
	2 1/2	S20WZ122502	
	3	S20WZ123002	
	3 1/2	S20WZ123502	50
	4	S20WZ124002	
	5	S20WZ125002	25
5/8 11 TPI	1.1/2	S20WZ161502	50
	2	S20WZ162002	
	2.1/2	S20WZ162502	25
	3	S20WZ163002	
	4	S20WZ164002	

MILD STEEL - BSW HEX

**BREMICK**<sup>TM</sup>



## HEXAGON HEAD BOLTS & NUTS

Metric 4.6 AS1111 - 2000 / AS1112 - 2000  
GALVANISED

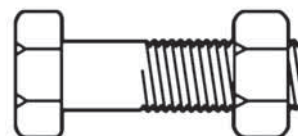

Diameter (mm)	Length (mm)	Product Code	Std. Pack
M6 1.0 mm Pitch	20	B46MG060201	200
	25	B46MG060251	
	30	B46MG060301	
	35	B46MG060351	
	40	B46MG060401	
	45	B46MG060451	
	50	B46MG060501	
	60	B46MG060601	150
	65	B46MG060651	
	75	B46MG060751	
	80	B46MG060801	
	90	B46MG060901	
	100	B46MG061001	
	130	B46MG061301	100
	150	B46MG061501	

Metric 4.6 AS1111 - 2000 / AS1112 - 2000  
ZINC PLATED

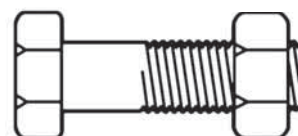

Diameter (mm)	Length (mm)	Product Code	Std. Pack
M6 1.0 mm Pitch	20	B46MZ060201	200
	25	B46MZ060251	
	30	B46MZ060301	
	35	B46MZ060351	
	40	B46MZ060401	
	45	B46MZ060451	
	50	B46MZ060501	
	55	B46MZ060551	150
	60	B46MZ060601	
	65	B46MZ060651	
	70	B46MZ060701	
	75	B46MZ060751	
	80	B46MZ060801	
	90	B46MZ060901	
	100	B46MZ061001	
	120	B46MZ061201	100
	130	B46MZ061301	
140	B46MZ061401		
150	B46MZ061501		

MILD STEEL - METRIC HEX

**BREMICK**<sup>TM</sup>

## HEXAGON HEAD BOLTS & NUTS

Metric 4.6 AS1111 - 2000 / AS1112 - 2000  
GALVANISED

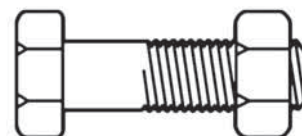

Diameter (mm)	Length (mm)	Product Code	Std. Pack
M8 1.25 mm Pitch	20	B46MG080201	200
	25	B46MG080251	
	30	B46MG080301	
	35	B46MG080351	
	40	B46MG080401	
	45	B46MG080451	150
	50	B46MG080501	
	55	B46MG080551	
	60	B46MG080601	
	65	B46MG080651	
	70	B46MG080701	100
	75	B46MG080751	
	80	B46MG080801	
	90	B46MG080901	
	100	B46MG081001	
	120	B46MG081201	
130	B46MG081301		
150	B46MG081501		

Metric 4.6 AS1111 - 2000 / AS1112 - 2000  
ZINC PLATED

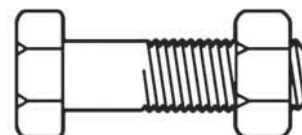

Diameter (mm)	Length (mm)	Product Code	Std. Pack
M8 1.25 mm Pitch	20	B46MZ080201	200
	25	B46MZ080251	
	30	B46MZ080301	
	35	B46MZ080351	
	40	B46MZ080401	
	45	B46MZ080451	150
	50	B46MZ080501	
	55	B46MZ080551	
	60	B46MZ080601	
	65	B46MZ080651	
	70	B46MZ080701	100
	75	B46MZ080751	
	80	B46MZ080801	
	90	B46MZ080901	
	100	B46MZ081001	
	120	B46MZ081201	
130	B46MZ081301		
140	B46MZ081401		
150	B46MZ081501		

## HEXAGON HEAD BOLTS & NUTS

Metric 4.6 AS1111 - 2000 / AS1112 - 2000  
PLAIN FINISH

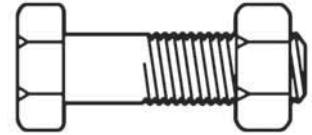

Diameter (mm)	Length (mm)	Product Code	Std. Pack
M10 1.5 mm Pitch	20	B46MP100201	150
	25	B46MP100251	
	30	B46MP100301	
	35	B46MP100351	
	40	B46MP100401	
	45	B46MP100451	
	50	B46MP100501	75
	55	B46MP100551	
	60	B46MP100601	
	65	B46MP100651	
	70	B46MP100701	
	75	B46MP100751	
	80	B46MP100801	
	90	B46MP100901	50
	100	B46MP101001	
	110	B46MP101101	
	120	B46MP101201	
	130	B46MP101301	
	140	B46MP101401	
	150	B46MP101501	
	160	B46MP101601	100
	170	B46MP101701	
	180	B46MP101801	
	190	B46MP101901	
	200	B46MP102001	
	220	B46MP102201	75
	240	B46MP102401	
	260	B46MP102601	
	280	B46MP102801	50
	300	B46MP103001	

MILD STEEL - METRIC HEX

**BREMICK**<sup>TM</sup>

## HEXAGON HEAD BOLTS & NUTS

Metric 4.6 AS1111 - 2000 / AS1112 - 2000  
GALVANISED

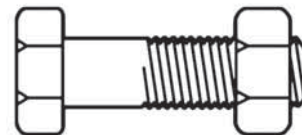

Diameter (mm)	Length (mm)	Product Code	Std. Pack
M10 1.5 mm Pitch	20	B46MG100201	150
	25	B46MG100251	
	30	B46MG100301	
	35	B46MG100351	
	40	B46MG100401	
	45	B46MG100451	
	50	B46MG100501	75
	55	B46MG100551	
	60	B46MG100601	
	65	B46MG100651	
	70	B46MG100701	
	75	B46MG100751	
	80	B46MG100801	
	90	B46MG100901	50
	100	B46MG101001	
	110	B46MG101101	
	120	B46MG101201	
	130	B46MG101301	
	140	B46MG101401	
	150	B46MG101501	
	160	B46MG101601	100
	170	B46MG101701	
	180	B46MG101801	
	190	B46MG101901	
	200	B46MG102001	
	220	B46MG102201	75
	240	B46MG102401	
	260	B46MG102601	
	280	B46MG102801	50
	300	B46MG103001	

## HEXAGON HEAD BOLTS & NUTS

Metric 4.6 AS1111 - 2000 / AS1112 - 2000  
ZINC PLATED

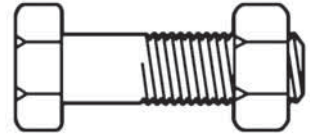

Diameter (mm)	Length (mm)	Product Code	Std. Pack
M10 1.5 mm Pitch	20	B46MZ100201	150
	25	B46MZ100251	
	30	B46MZ100301	
	35	B46MZ100351	
	40	B46MZ100401	
	45	B46MZ100451	
	50	B46MZ100501	75
	55	B46MZ100551	
	60	B46MZ100601	
	65	B46MZ100651	
	70	B46MZ100701	
	75	B46MZ100751	
	80	B46MZ100801	
	90	B46MZ100901	50
	100	B46MZ101001	
	110	B46MZ101101	
	120	B46MZ101201	
	130	B46MZ101301	
	140	B46MZ101401	
	150	B46MZ101501	

MILD STEEL - METRIC HEX

**BREMICK**<sup>TM</sup>

## HEXAGON HEAD BOLTS & NUTS

Metric 4.6 AS1111 - 2000 / AS1112 - 2000  
PLAIN FINISH

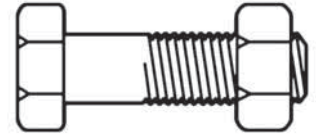

Diameter (mm)	Length (mm)	Product Code	Std. Pack
M12 1.75 mm Pitch	25	B46MP120251	200
	30	B46MP120301	
	35	B46MP120351	
	40	B46MP120401	
	45	B46MP120451	
	50	B46MP120501	150
	55	B46MP120551	
	60	B46MP120601	
	65	B46MP120651	
	70	B46MP120701	
	75	B46MP120751	
	80	B46MP120801	
	85	B46MP120851	100
	90	B46MP120901	
	100	B46MP121001	
	110	B46MP121101	
	120	B46MP121201	
	130	B46MP121301	75
	140	B46MP121401	
	150	B46MP121501	
	160	B46MP121601	
	170	B46MP121701	
	180	B46MP121801	50
	200	B46MP122001	
	220	B46MP122201	
	240	B46MP122401	
	260	B46MP122601	
	280	B46MP122801	
	300	B46MP123001	



## HEXAGON HEAD BOLTS & NUTS

Metric 4.6 AS1111 - 2000 / AS1112 - 2000  
GALVANISED

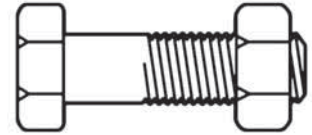

Diameter (mm)	Length (mm)	Product Code	Std. Pack
<b>M12</b> <b>1.75 mm</b> <b>Pitch</b>	25	B46MG120251	200
	30	B46MG120301	
	35	B46MG120351	
	40	B46MG120401	
	45	B46MG120451	
	50	B46MG120501	150
	55	B46MG120551	
	60	B46MG120601	
	65	B46MG120651	
	70	B46MG120701	
	75	B46MG120751	
	80	B46MG120801	
	85	B46MG120851	100
	90	B46MG120901	
	100	B46MG121001	
	110	B46MG121101	
	120	B46MG121201	
	130	B46MG121301	75
	140	B46MG121401	
	150	B46MG121501	
	160	B46MG121601	
	170	B46MG121701	
	180	B46MG121801	50
	200	B46MG122001	
	220	B46MG122201	
	240	B46MG122401	
	260	B46MG122601	
	280	B46MG122801	
	300	B46MG123001	
	325	B46MG123251	
350	B46MG123501		
375	B46MG123751		
400	B46MG124001		
425	B46MG124251	25	
450	B46MG124501		
500	B46MG125001		
550	B46MG125501		
600	B46MG126001		

MILD STEEL - METRIC HEX

**BREMICK**<sup>TM</sup>

## HEXAGON HEAD BOLTS & NUTS

Metric 4.6 AS1111 - 2000 / AS1112 - 2000  
ZINC PLATED

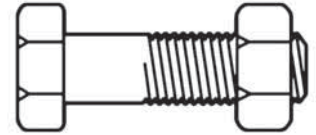

Diameter (mm)	Length (mm)	Product Code	Std. Pack
<b>M12</b>  <b>1.75 mm Pitch</b>	25	B46MZ120251	200
	30	B46MZ120301	
	35	B46MZ120351	
	40	B46MZ120401	
	45	B46MZ120451	
	50	B46MZ120501	150
	55	B46MZ120551	
	60	B46MZ120601	
	65	B46MZ120651	
	70	B46MZ120701	
	75	B46MZ120751	
	80	B46MZ120801	
	85	B46MZ120851	100
	90	B46MZ120901	
	100	B46MZ121001	
	110	B46MZ121101	
	120	B46MZ121201	
	130	B46MZ121301	75
	140	B46MZ121401	
	150	B46MZ121501	

## HEXAGON HEAD BOLTS & NUTS

Metric 4.6 AS1111 - 2000 / AS1112 - 2000  
PLAIN FINISH

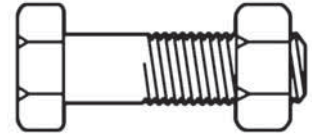

Diameter (mm)	Length (mm)	Product Code	Std. Pack
M16 2.0 mm Pitch	25	B46MP160251	100
	30	B46MP160301	
	35	B46MP160351	
	40	B46MP160401	
	45	B46MP160451	
	50	B46MP160501	
	55	B46MP160551	75
	60	B46MP160601	
	65	B46MP160651	
	70	B46MP160701	50
	75	B46MP160751	
	80	B46MP160801	
	85	B46MP160851	
	90	B46MP160901	
	100	B46MP161001	
	110	B46MP161101	
	120	B46MP161201	
	130	B46MP161301	
	140	B46MP161401	
	150	B46MP161501	
	160	B46MP161601	
	170	B46MP161701	30
	180	B46MP161801	
	190	B46MP161901	
	200	B46MP162001	
	220	B46MP162201	
	240	B46MP162401	
	260	B46MP162601	25
	280	B46MP162801	
	300	B46MP163001	

MILD STEEL - METRIC HEX

**BREMICK**<sup>TM</sup>

## HEXAGON HEAD BOLTS & NUTS

Metric 4.6 AS1111 - 2000 / AS1112 - 2000  
GALVANISED

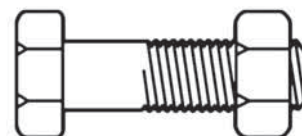

Diameter (mm)	Length (mm)	Product Code	Std. Pack
M16 2.0 mm Pitch	25	B46MG160251	100
	30	B46MG160301	
	35	B46MG160351	
	40	B46MG160401	
	45	B46MG160451	
	50	B46MG160501	
	55	B46MG160551	75
	60	B46MG160601	
	65	B46MG160651	
	70	B46MG160701	50
	75	B46MG160751	
	80	B46MG160801	
	85	B46MG160851	
	90	B46MG160901	
	100	B46MG161001	
	110	B46MG161101	
	120	B46MG161201	
	130	B46MG161301	
	140	B46MG161401	
	150	B46MG161501	
	160	B46MG161601	
	170	B46MG161701	30
	180	B46MG161801	
	190	B46MG161901	
	200	B46MG162001	
	220	B46MG162201	
	240	B46MG162401	
	260	B46MG162601	25
	280	B46MG162801	
	300	B46MG163001	
	325	B46MG163251	
	350	B46MG163501	
	375	B46MG163751	
400	B46MG164001		
425	B46MG164251		
450	B46MG164501		
475	B46MG164751		
500	B46MG165001		
550	B46MG165501	15	
600	B46MG166001		

## HEXAGON HEAD BOLTS & NUTS

Metric 4.6 AS1111 - 2000 / AS1112 - 2000  
ZINC PLATED

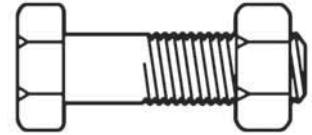

Diameter (mm)	Length (mm)	Product Code	Std. Pack
M16 2.0 mm Pitch	25	B46MZ160251	100
	30	B46MZ160301	
	35	B46MZ160351	
	40	B46MZ160401	
	45	B46MZ160451	
	50	B46MZ160501	
	55	B46MZ160551	75
	60	B46MZ160601	
	65	B46MZ160651	
	70	B46MZ160701	50
	75	B46MZ160751	
	80	B46MZ160801	
	85	B46MZ160851	
	90	B46MZ160901	
	100	B46MZ161001	
	110	B46MZ161101	
	120	B46MZ161201	
	130	B46MZ161301	
	140	B46MZ161401	
	150	B46MZ161501	

## HEXAGON HEAD BOLTS & NUTS

Metric 4.6 AS1111 - 2000 / AS1112 - 2000  
PLAIN FINISH

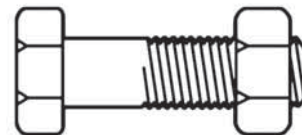

Diameter (mm)	Length (mm)	Product Code	Std. Pack
M20 2.5 mm Pitch	35	B46MP200351	50
	40	B46MP200401	
	45	B46MP200451	
	50	B46MP200501	
	55	B46MP200551	
	60	B46MP200601	
	65	B46MP200651	
	70	B46MP200701	
	75	B46MP200751	
	80	B46MP200801	
	85	B46MP200851	30
	90	B46MP200901	
	100	B46MP201001	
	110	B46MP201101	
	120	B46MP201201	
	130	B46MP201301	
	140	B46MP201401	25
	150	B46MP201501	
	160	B46MP201601	
	170	B46MP201701	
	180	B46MP201801	
	190	B46MP201901	
	200	B46MP202001	20
	220	B46MP202201	
	240	B46MP202401	15
	260	B46MP202601	
	280	B46MP202801	
	300	B46MP203001	

## HEXAGON HEAD BOLTS & NUTS

Metric 4.6 AS1111 - 2000 / AS1112 - 2000  
GALVANISED

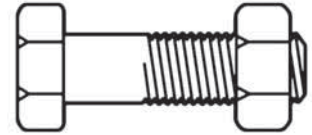

Diameter (mm)	Length (mm)	Product Code	Std. Pack
M20 2.5 mm Pitch	35	B46MG200351	50
	40	B46MG200401	
	45	B46MG200451	
	50	B46MG200501	
	55	B46MG200551	
	60	B46MG200601	
	65	B46MG200651	
	70	B46MG200701	
	75	B46MG200751	
	80	B46MG200801	
	85	B46MG200851	30
	90	B46MG200901	
	100	B46MG201001	
	110	B46MG201101	
	120	B46MG201201	
	130	B46MG201301	
	140	B46MG201401	25
	150	B46MG201501	
	160	B46MG201601	
	170	B46MG201701	
	180	B46MG201801	
	190	B46MG201901	
	200	B46MG202001	20
	220	B46MG202201	
	240	B46MG202401	15
	260	B46MG202601	
	280	B46MG202801	
	300	B46MG203001	
	325	B46MG203251	
	350	B46MG203501	
	375	B46MG203751	10
	400	B46MG204001	
	425	B46MG204251	
	450	B46MG204501	
	475	B46MG204751	
	500	B46MG205001	
	525	B46MG205251	
	550	B46MG205501	
	575	B46MG205751	
	600	B46MG206001	
650	B46MG206501		
700	B46MG207001	8	
750	B46MG207501		
800	B46MG208001		

MILD STEEL - METRIC HEX

**BREMICK**<sup>TM</sup>

## HEXAGON HEAD BOLTS & NUTS

Metric 4.6 AS1111 - 2000 / AS1112 - 2000  
ZINC PLATED

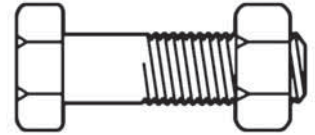

Diameter (mm)	Length (mm)	Product Code	Std. Pack
M20 2.5 mm Pitch	35	B46MZ200351	50
	40	B46MZ200401	
	45	B46MZ200451	
	50	B46MZ200501	
	55	B46MZ200551	
	60	B46MZ200601	
	65	B46MZ200651	
	70	B46MZ200701	
	75	B46MZ200751	
	80	B46MZ200801	
	85	B46MZ200851	30
	90	B46MZ200901	
	100	B46MZ201001	
	110	B46MZ201101	
	120	B46MZ201201	
	130	B46MZ201301	
	140	B46MZ201401	25
150	B46MZ201501		



## HEXAGON HEAD BOLTS & NUTS

Metric 4.6 AS1111 - 2000 / AS1112 - 2000  
PLAIN FINISH

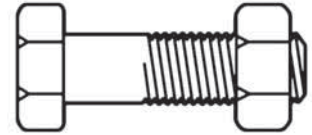

Diameter (mm)	Length (mm)	Product Code	Std. Pack
M24 3.0 mm Pitch	50	B46MP240501	25
	55	B46MP240551	
	60	B46MP240601	
	65	B46MP240651	
	70	B46MP240701	
	75	B46MP240751	
	80	B46MP240801	
	85	B46MP240851	
	90	B46MP240901	
	100	B46MP241001	20
	110	B46MP241101	
	120	B46MP241201	
	130	B46MP241301	
	140	B46MP241401	
	150	B46MP241501	15
	160	B46MP241601	
	170	B46MP241701	
	180	B46MP241801	
	190	B46MP241901	
	200	B46MP242001	
	220	B46MP242201	
	240	B46MP242401	10
	260	B46MP242601	
	280	B46MP242801	
	300	B46MP243001	

MILD STEEL - METRIC HEX

**BREMICK**<sup>TM</sup>

## HEXAGON HEAD BOLTS & NUTS

Metric 4.6 AS1111 - 2000 / AS1112 - 2000  
GALVANISED

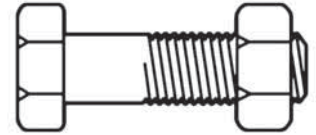

Diameter (mm)	Length (mm)	Product Code	Std. Pack
M24 3.0 mm Pitch	50	B46MG240501	25
	55	B46MG240551	
	60	B46MG240601	
	65	B46MG240651	
	70	B46MG240701	
	75	B46MG240751	
	80	B46MG240801	
	85	B46MG240851	
	90	B46MG240901	
	100	B46MG241001	20
	110	B46MG241101	
	120	B46MG241201	
	130	B46MG241301	
	140	B46MG241401	
	150	B46MG241501	15
	160	B46MG241601	
	170	B46MG241701	
	180	B46MG241801	
	190	B46MG241901	
	200	B46MG242001	
	220	B46MG242201	
	240	B46MG242401	10
	260	B46MG242601	
	280	B46MG242801	
	300	B46MG243001	
	325	B46MG243251	
	350	B46MG243501	
	375	B46MG243751	
	400	B46MG244001	
	425	B46MG244251	
	450	B46MG244501	
	475	B46MG244751	5
	500	B46MG245001	
	525	B46MG245251	
	550	B46MG245501	
	575	B46MG245751	
	600	B46MG246001	
	650	B46MG246501	4
	700	B46MG247001	
	750	B46MG247501	
800	B46MG248001		

## HEXAGON HEAD BOLTS & NUTS

Metric 4.6 AS1111 - 2000 / AS1112 - 2000  
PLAIN FINISH

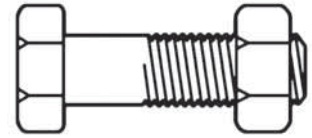

Diameter (mm)	Length (mm)	Product Code	Std. Pack
M30 3.5 mm Pitch	75	B46MP300751	10
	90	B46MP300901	
	100	B46MP301001	
	110	B46MP301101	
	120	B46MP301201	
	130	B46MP301301	
	140	B46MP301401	
	150	B46MP301501	5
	180	B46MP301801	
	200	B46MP302001	
	220	B46MP302201	
	240	B46MP302401	
	260	B46MP302601	
	280	B46MP302801	
	300	B46MP303001	

Metric 4.6 AS1111 - 2000 / AS1112 - 2000  
GALVANISED

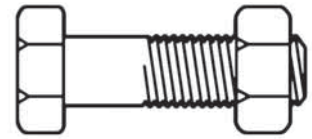

Diameter (mm)	Length (mm)	Product Code	Std. Pack
M30 3.5 mm Pitch	75	B46MG300751	10
	90	B46MG300901	
	100	B46MG301001	
	110	B46MG301101	
	120	B46MG301201	
	130	B46MG301301	
	140	B46MG301401	
	150	B46MG301501	5
	180	B46MG301801	
	200	B46MG302001	
	220	B46MG302201	
	240	B46MG302401	
	260	B46MG302601	
	280	B46MG302801	
	300	B46MG303001	
	350	B46MG303501	4
	400	B46MG304001	
	450	B46MG304501	
	500	B46MG305001	
	550	B46MG305501	
600	B46MG306001		
700	B46MG307001	2	
800	B46MG308001		

MILD STEEL - METRIC HEX

**BREMICK**<sup>TM</sup>

## HEXAGON HEAD BOLTS & NUTS

Metric 4.6 AS1111 - 2000 / AS1112 - 2000  
PLAIN FINISH

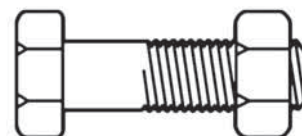

Diameter (mm)	Length (mm)	Product Code	Std. Pack
M36 4.0 mm Pitch	100	B46MP361001	5
	130	B46MP361301	
	150	B46MP361501	
	170	B46MP361701	
	200	B46MP362001	
	220	B46MP362201	
	240	B46MP362401	
	260	B46MP362601	
	280	B46MP362801	
	300	B46MP363001	

Metric 4.6 AS1111 - 2000 / AS1112 - 2000  
GALVANISED

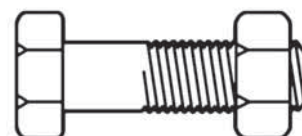

Diameter (mm)	Length (mm)	Product Code	Std. Pack
M36 4.0 mm Pitch	100	B46MG361001	5
	130	B46MG361301	
	150	B46MG361501	
	170	B46MG361701	
	200	B46MG362001	
	220	B46MG362201	
	240	B46MG362401	
	260	B46MG362601	
	280	B46MG362801	
	300	B46MG363001	
	400	B46MG364001	2
	500	B46MG365001	
	600	B46MG366001	
	700	B46MG367001	
	800	B46MG368001	

## HEXAGON HEAD SET SCREWS

Metric 4.6 AS1111 - 2000  
ZINC PLATED

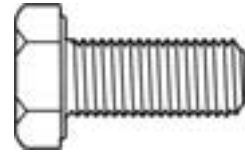

Diameter (mm)	Length (mm)	Product Code	Std. Pack
M6 1.0 mm Pitch	10	S46MZ060102	200
	12	S46MZ060122	
	16	S46MZ060162	
	20	S46MZ060202	
	25	S46MZ060252	
	30	S46MZ060302	
	40	S46MZ060402	
	50	S46MZ060502	
	65	S46MZ060652	150
	75	S46MZ060752	
M8 1.25 mm Pitch	12	S46MZ080122	200
	16	S46MZ080162	
	20	S46MZ080202	
	25	S46MZ080252	
	30	S46MZ080302	
	35	S46MZ080352	
	40	S46MZ080402	
	50	S46MZ080502	
	65	S46MZ080652	150
	75	S46MZ080752	
M10 1.5 mm Pitch	16	S46MZ100162	150
	20	S46MZ100202	
	25	S46MZ100252	
	30	S46MZ100302	
	35	S46MZ100352	
	40	S46MZ100402	
	50	S46MZ100502	75
	65	S46MZ100652	
	75	S46MZ100752	
	90	S46MZ100902	50
100	S46MZ101002		

MILD STEEL - METRIC HEX

**BREMICK**<sup>TM</sup>



## HEXAGON HEAD SET SCREWS

Metric 4.6 AS1111 - 2000  
ZINC PLATED

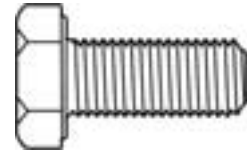

Diameter (mm)	Length (mm)	Product Code	Std. Pack
M12 1.75 mm Pitch	20	S46MZ120202	100
	25	S46MZ120252	
	30	S46MZ120302	
	35	S46MZ120352	
	40	S46MZ120402	
	50	S46MZ120502	75
	60	S46MZ120602	
	75	S46MZ120752	
	90	S46MZ120902	50
	100	S46MZ121002	
	110	S46MZ121102	
	130	S46MZ121302	
150	S46MZ121502		
M16 2.0 mm Pitch	30	S46MZ160302	50
	40	S46MZ160402	
	50	S46MZ160502	
	60	S46MZ160602	
	75	S46MZ160752	25
	90	S46MZ160902	
	100	S46MZ161002	
	130	S46MZ161302	
150	S46MZ161502		
M20 2.5 mm Pitch	40	S46MZ200402	25
	50	S46MZ200502	
	60	S46MZ200602	20
	75	S46MZ200752	
	100	S46MZ201002	
	130	S46MZ201302	10
150	S46MZ201502		

MILD STEEL - METRIC HEX

BREMICK™

## CUP HEAD BSW BOLTS & NUTS



AS B108 - 1952 / AS 2451 - 1998  
ZINC PLATED

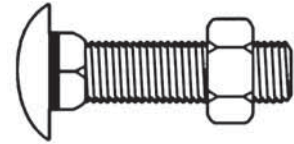

Diameter (inches)	Length (inches)	Product Code	Std. Pack
1/4 20 TPI	3/4	BCHWZ060751	150
	1	BCHWZ061001	
	1.1/4	BCHWZ061251	
	1.1/2	BCHWZ061501	
	1.3/4	BCHWZ061751	
	2	BCHWZ062001	
	2.1/2	BCHWZ062501	
	3	BCHWZ063001	
	3.1/2	BCHWZ063501	
	4	BCHWZ064001	
	4.1/2	BCHWZ064501	100
	5	BCHWZ065001	
	5.1/2	BCHWZ065501	
	6	BCHWZ066001	
5/16 18 TPI	3/4	BCHWZ080751	150
	1	BCHWZ081001	
	1.1/4	BCHWZ081251	
	1.1/2	BCHWZ081501	
	2	BCHWZ082001	
	2.1/2	BCHWZ082501	
	3	BCHWZ083001	100
	3.1/2	BCHWZ083501	
	4	BCHWZ084001	
	4.1/2	BCHWZ084501	
	5	BCHWZ085001	
	5.1/2	BCHWZ085501	
	6	BCHWZ086001	
7	BCHWZ087001		

MILD STEEL - BSW CUP

BREMICK™



## CUP HEAD BSW BOLTS & NUTS

AS B108 - 1952 / AS 2451 - 1998  
ZINC PLATED

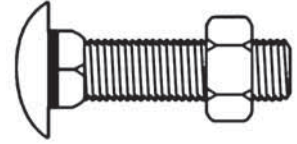

Diameter (inches)	Length (inches)	Product Code	Std. Pack	
<b>3/8</b>	3/4	BCHWZ100751	150	
	1	BCHWZ101001		
	1.1/2	BCHWZ101501		
	2	BCHWZ102001	100	
	2.1/2	BCHWZ102501		
	3	BCHWZ103001		
	3.1/2	BCHWZ103501	50	
	4	BCHWZ104001		
	4.1/2	BCHWZ104501		
	5	BCHWZ105001		
	5.1/2	BCHWZ105501		
	6	BCHWZ106001		
<b>16 TPI</b>	6 1/2	BCHWZ106501		
	7	BCHWZ107001		
	8	BCHWZ108001	25	
	9	BCHWZ109001		
	10	BCHWZ10X101		
	11	BCHWZ10X111		
	12	BCHWZ10X121		
	<b>1/2</b>	1.1/2	BCHWZ121501	25
		2	BCHWZ122001	
		2.1/2	BCHWZ122501	
		3	BCHWZ123001	
		3.1/2	BCHWZ123501	
4		BCHWZ124001		
4.1/2		BCHWZ124501		
5		BCHWZ125001		
5.1/2		BCHWZ125501		
6		BCHWZ126001		
6 1/2		BCHWZ126501		
7		BCHWZ127001		
<b>12 TPI</b>	8	BCHWZ128001		
	9	BCHWZ129001		
	10	BCHWZ12X101		
	11	BCHWZ12X111		
	12	BCHWZ12X121		

MILD STEEL - BSW CUP

BREMICK™



## CUP HEAD METRIC BOLTS & NUTS



AS 1390 - 1997 / AS 1112 - 2000  
GALVANISED

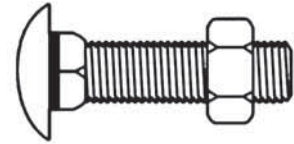

Diameter (mm)	Length (mm)	Product Code	Std. Pack
M6 1.0 mm Pitch	20	BCHMG060201	200
	25	BCHMG060251	
	30	BCHMG060301	
	40	BCHMG060401	
	45	BCHMG060451	
	50	BCHMG060501	
	60	BCHMG060601	150
	65	BCHMG060651	
	70	BCHMG060701	
	75	BCHMG060751	
	90	BCHMG060901	
	100	BCHMG061001	

AS 1390 - 1997 / AS 1112 - 2000  
ZINC PLATED

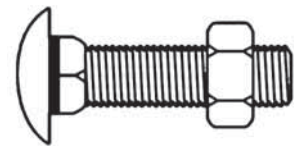

Diameter (mm)	Length (mm)	Product Code	Std. Pack
M6 1.0 mm Pitch	20	BCHMZ060201	200
	25	BCHMZ060251	
	30	BCHMZ060301	
	40	BCHMZ060401	
	45	BCHMZ060451	
	50	BCHMZ060501	
	60	BCHMZ060601	150
	65	BCHMZ060651	
	70	BCHMZ060701	
	75	BCHMZ060751	
	80	BCHMZ060801	
	90	BCHMZ060901	
	100	BCHMZ061001	
110	BCHMZ061101	100	

MILD STEEL - METRIC CUP

BREMICK™



## CUP HEAD METRIC BOLTS & NUTS

AS 1390 - 1997 / AS 1112 - 2000  
GALVANISED

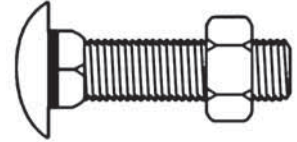

Diameter (mm)	Length (mm)	Product Code	Std. Pack
M8 1.25 mm Pitch	20	BCHMG080201	200
	25	BCHMG080251	
	30	BCHMG080301	
	40	BCHMG080401	
	45	BCHMG080451	150
	50	BCHMG080501	
	60	BCHMG080601	
	65	BCHMG080651	
	70	BCHMG080701	100
	75	BCHMG080751	
	90	BCHMG080901	
	100	BCHMG081001	
	110	BCHMG081101	
	120	BCHMG081201	
	130	BCHMG081301	
	140	BCHMG081401	
	150	BCHMG081501	
	180	BCHMG081801	50

AS 1390 - 1997 / AS 1112 - 2000  
GALVANISED

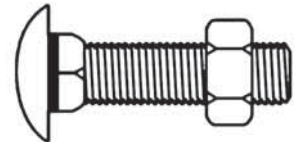

Diameter (mm)	Length (mm)	Product Code	Std. Pack
M8 1.25 mm Pitch	20	BCHMZ080201	200
	25	BCHMZ080251	
	30	BCHMZ080301	
	40	BCHMZ080401	
	45	BCHMZ080451	150
	50	BCHMZ080501	
	60	BCHMZ080601	
	65	BCHMZ080651	
	70	BCHMZ080701	100
	75	BCHMZ080751	
	90	BCHMZ080901	
	100	BCHMZ081001	
	110	BCHMZ081101	
	120	BCHMZ081201	
	130	BCHMZ081301	
	140	BCHMZ081401	
	150	BCHMZ081501	

## CUP HEAD METRIC BOLTS & NUTS



AS 1390 - 1997 / AS 1112 - 2000  
GALVANISED

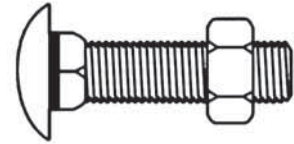

Diameter (mm)	Length (mm)	Product Code	Std. Pack
M10 1.5 mm Pitch	25	BCHMG100251	200
	30	BCHMG100301	
	40	BCHMG100401	150
	45	BCHMG100451	
	50	BCHMG100501	100
	60	BCHMG100601	
	65	BCHMG100651	
	70	BCHMG100701	
	75	BCHMG100751	
	85	BCHMG100851	
	90	BCHMG100901	50
	100	BCHMG101001	
	110	BCHMG101101	
	120	BCHMG101201	
	130	BCHMG101301	
	140	BCHMG101401	
	150	BCHMG101501	
	160	BCHMG101601	100
	170	BCHMG101701	
	180	BCHMG101801	
	190	BCHMG101901	
	200	BCHMG102001	
	220	BCHMG102201	
	240	BCHMG102401	75
	260	BCHMG102601	
	280	BCHMG102801	
	300	BCHMG103001	
	325	BCHMG103251	
	350	BCHMG103501	
	375	BCHMG103751	
	400	BCHMG104001	

MILD STEEL - METRIC CUP

**BREMICK**<sup>TM</sup>



## CUP HEAD METRIC BOLTS & NUTS

AS 1390 - 1997 / AS 1112 - 2000  
ZINC PLATED

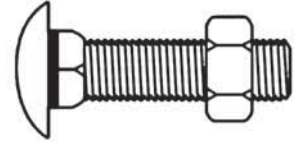

Diameter (mm)	Length (mm)	Product Code	Std. Pack
<b>M10</b>  <b>1.5 mm Pitch</b>	20	BCHMZ100201	200
	25	BCHMZ100251	
	30	BCHMZ100301	
	40	BCHMZ100401	150
	45	BCHMZ100451	
	50	BCHMZ100501	100
	60	BCHMZ100601	
	65	BCHMZ100651	
	70	BCHMZ100701	
	75	BCHMZ100751	
	85	BCHMZ100851	
	90	BCHMZ100901	50
	100	BCHMZ101001	
	110	BCHMZ101101	
	120	BCHMZ101201	
	130	BCHMZ101301	
	140	BCHMZ101401	
	150	BCHMZ101501	
	170	BCHMZ101701	100
	180	BCHMZ101801	
190	BCHMZ101901		
200	BCHMZ102001		

MILD STEEL - METRIC CUP

**BREMICK**<sup>TM</sup>

## CUP HEAD METRIC BOLTS & NUTS



AS 1390 - 1997 / AS 1112 - 2000  
GALVANISED

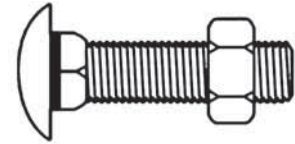

Diameter (mm)	Length (mm)	Product Code	Std. Pack
M12 1.75 mm Pitch	30	BCHMG120301	200
	40	BCHMG120401	
	45	BCHMG120451	150
	50	BCHMG120501	
	65	BCHMG120651	
	70	BCHMG120701	
	75	BCHMG120751	
	85	BCHMG120851	100
	90	BCHMG120901	
	100	BCHMG121001	
	110	BCHMG121101	
	120	BCHMG121201	
	130	BCHMG121301	75
	140	BCHMG121401	
	150	BCHMG121501	
	160	BCHMG121601	
	170	BCHMG121701	
	180	BCHMG121801	
	190	BCHMG121901	
	200	BCHMG122001	
	220	BCHMG122201	50
	240	BCHMG122401	
	260	BCHMG122601	
	280	BCHMG122801	
	300	BCHMG123001	
	325	BCHMG123251	
	350	BCHMG123501	
	375	BCHMG123751	
	400	BCHMG124001	
	450	BCHMG124501	
500	BCHMG125001		

MILD STEEL - METRIC CUP

**BREMICK**<sup>TM</sup>



## CUP HEAD METRIC BOLTS & NUTS

AS 1390 - 1997 / AS 1112 - 2000  
ZINC PLATED

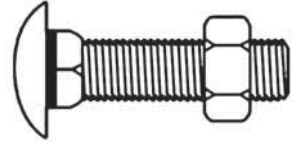

Diameter (mm)	Length (mm)	Product Code	Std. Pack
M12 1.75 mm Pitch	40	BCHMZ120401	200
	50	BCHMZ120501	150
	65	BCHMZ120651	
	75	BCHMZ120751	
	90	BCHMZ120901	100
	100	BCHMZ121001	
	120	BCHMZ121201	
	130	BCHMZ121301	75
	150	BCHMZ121501	
	180	BCHMZ121801	
	200	BCHMZ122001	

## CUP HEAD METRIC BOLTS & NUTS



AS 1390 - 1997 / AS 1112 - 2000  
GALVANISED

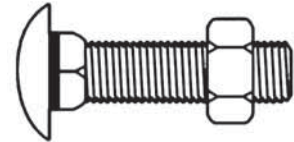

Diameter (mm)	Length (mm)	Product Code	Std. Pack
M16 2.0 mm Pitch	50	BCHMG160501	100
	65	BCHMG160651	75
	75	BCHMG160751	
	90	BCHMG160901	50
	100	BCHMG161001	
	120	BCHMG161201	
	130	BCHMG161301	
	140	BCHMG161401	
	150	BCHMG161501	
	160	BCHMG161601	
	170	BCHMG161701	30
	180	BCHMG161801	
	200	BCHMG162001	
	220	BCHMG162201	
	240	BCHMG162401	
	260	BCHMG162601	25
	280	BCHMG162801	
	300	BCHMG163001	
	325	BCHMG163251	
	350	BCHMG163501	
375	BCHMG163751		
400	BCHMG164001		
450	BCHMG164501		
500	BCHMG165001		

MILD STEEL - METRIC CUP

**BREMICK**<sup>TM</sup>



## CUP HEAD METRIC BOLTS & NUTS

AS 1390 - 1997 / AS 1112 - 2000  
GALVANISED

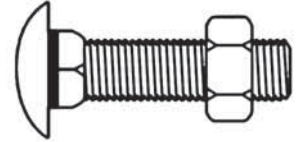

Diameter (mm)	Length (mm)	Product Code	Std. Pack
M20 2.5 mm Pitch	50	BCHMG200501	50
	65	BCHMG200651	
	75	BCHMG200751	
	90	BCHMG200901	30
	100	BCHMG201001	
	120	BCHMG201201	
	130	BCHMG201301	
	140	BCHMG201401	
	150	BCHMG201501	
	180	BCHMG201801	
	200	BCHMG202001	
	220	BCHMG202201	25
	240	BCHMG202401	
	260	BCHMG202601	20
	280	BCHMG202801	
	300	BCHMG203001	
	350	BCHMG203501	10
	400	BCHMG204001	
	450	BCHMG204501	
	500	BCHMG205001	
550	BCHMG205501		
600	BCHMG206001		

MILD STEEL - METRIC CUP

BREMICK™



## HEXAGON COACH SCREWS



**AS 1393 - 1996  
GALVANISED**

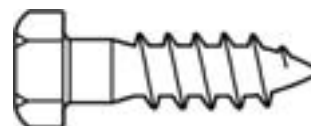

Diameter (mm)	Length (mm)	Product Code	Std. Pack
6	25	SCSMG060252	150
	30	SCSMG060302	
	40	SCSMG060402	
	50	SCSMG060502	
	65	SCSMG060652	
	75	SCSMG060752	
	100	SCSMG061002	

**AS 1393 - 1996  
ZINC PLATED**

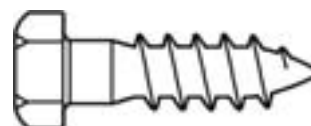

Diameter (mm)	Length (mm)	Product Code	Std. Pack
6	25	SCSMZ060252	150
	30	SCSMZ060302	
	40	SCSMZ060402	
	50	SCSMZ060502	
	65	SCSMZ060652	
	75	SCSMZ060752	
	90	SCSMZ060902	
100	SCSMZ061002		

**MILD STEEL - METRIC COACH**

**BREMICK™**



## HEXAGON COACH SCREWS

**AS 1393 - 1996  
GALVANISED**

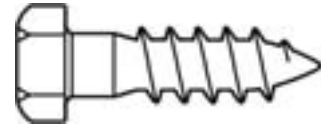

Diameter (mm)	Length (mm)	Product Code	Std. Pack
8	30	SCSMG080302	100
	40	SCSMG080402	
	50	SCSMG080502	
	65	SCSMG080652	
	75	SCSMG080752	
	90	SCSMG080902	
	100	SCSMG081002	

**AS 1393 - 1996  
ZINC PLATED**

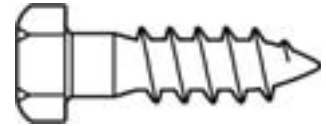

Diameter (mm)	Length (mm)	Product Code	Std. Pack
8	30	SCSMZ080302	150
	40	SCSMZ080402	
	50	SCSMZ080502	
	65	SCSMZ080652	
	75	SCSMZ080752	
	90	SCSMZ080902	
	100	SCSMZ081002	

## HEXAGON COACH SCREWS



**AS 1393 - 1996  
GALVANISED**

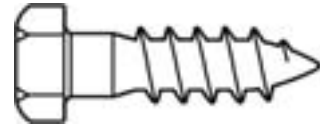

Diameter (mm)	Length (mm)	Product Code	Std. Pack
10	40	SCSMG100402	100
	50	SCSMG100502	
	65	SCSMG100652	
	75	SCSMG100752	
	90	SCSMG100902	
	100	SCSMG101002	50
	120	SCSMG101202	
	130	SCSMG101302	
	150	SCSMG101502	

**AS 1393 - 1996  
ZINC PLATED**



Diameter (mm)	Length (mm)	Product Code	Std. Pack
10	40	SCSMZ100402	100 202.00
	50	SCSMZ100502	
	65	SCSMZ100652	
	75	SCSMZ100752	
	90	SCSMZ100902	
	100	SCSMZ101002	
	120	SCSMZ101202	
	130	SCSMZ101302	
	150	SCSMZ101502	

MILD STEEL - METRIC COACH

**BREMICK**<sup>TM</sup>



## HEXAGON COACH SCREWS

**AS 1393 - 1996  
GALVANISED**



Diameter (mm)	Length (mm)	Product Code	Std. Pack
12	40	SCSMG120402	25
	50	SCSMG120502	
	65	SCSMG120652	
	75	SCSMG120752	
	90	SCSMG120902	
	100	SCSMG121002	
	120	SCSMG121202	
	130	SCSMG121302	
	150	SCSMG121502	
	180	SCSMG121802	
	200	SCSMG122002	

**AS 1393 - 1996  
ZINC PLATED**

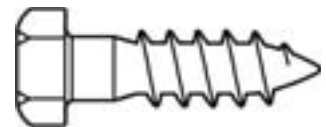

Diameter (mm)	Length (mm)	Product Code	Std. Pack
12	50	SCSMZ120502	50
	65	SCSMZ120652	
	75	SCSMZ120752	
	90	SCSMZ120902	
	100	SCSMZ121002	
	130	SCSMZ121302	
	150	SCSMZ121502	
	200	SCSMZ122002	

## HEXAGON COACH SCREWS



**AS 1393 - 1996  
GALVANISED**

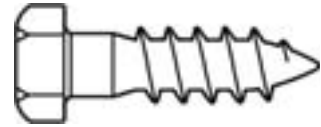

Diameter (mm)	Length (mm)	Product Code	Std. Pack
16	50	SCSMG160502	100
	75	SCSMG160752	
	100	SCSMG161002	
	130	SCSMG161302	
	150	SCSMG161502	50
	200	SCSMG162002	
20	100	SCSMG201002	30
	130	SCSMG201302	
	150	SCSMG201502	
	200	SCSMG202002	25

MILD STEEL - METRIC COACH

**BREMICK**<sup>TM</sup>



## BOLT, NUT & WASHER ASSEMBLY

**Class 8.8 Metric AS 1252 - 1983  
GALVANISED**

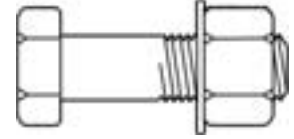

Diameter (mm)	Length (mm)	Product Code	Std. Pack
<b>M16</b> <b>2.0 mm</b> <b>Pitch</b>	40	BSAMG160401	100
	45	BSAMG160451	
	50	BSAMG160501	
	55	BSAMG160551	
	60	BSAMG160601	
	65	BSAMG160651	75
	70	BSAMG160701	
	75	BSAMG160751	
	80	BSAMG160801	
	90	BSAMG160901	
	100	BSAMG161001	
	110	BSAMG161101	60
	120	BSAMG161201	
	130	BSAMG161301	
	140	BSAMG161401	50
	150	BSAMG161501	
	160	BSAMG161601	40
	180	BSAMG161801	
	200	BSAMG162001	
	220	BSAMG162201	30
	240	BSAMG162401	
	260	BSAMG162601	
	300	BSAMG163001	
	350	BSAMG163501	
	400	BSAMG164001	
	450	BSAMG164501	
	500	BSAMG165001	20
	550	BSAMG165501	
	600	BSAMG166001	
	650	BSAMG166501	
	700	BSAMG167001	

# BOLT, NUT & WASHER ASSEMBLY



**Class 8.8 Metric AS 1252 - 1983  
GALVANISED**

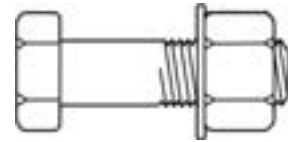

Diameter (mm)	Length (mm)	Product Code	Std. Pack
M20 2.5 mm Pitch	40	BSAMG200401	75
	45	BSAMG200451	
	50	BSAMG200501	50
	55	BSAMG200551	
	60	BSAMG200601	
	65	BSAMG200651	
	70	BSAMG200701	
	75	BSAMG200751	
	80	BSAMG200801	
	85	BSAMG200851	
	90	BSAMG200901	40
	100	BSAMG201001	
	110	BSAMG201101	
	120	BSAMG201201	30
	130	BSAMG201301	
	140	BSAMG201401	
	150	BSAMG201501	
	160	BSAMG201601	
	180	BSAMG201801	
	200	BSAMG202001	
	220	BSAMG202201	
	240	BSAMG202401	20
	260	BSAMG202601	
	280	BSAMG202801	
	300	BSAMG203001	
	350	BSAMG203501	
	400	BSAMG204001	
	450	BSAMG204501	15
	500	BSAMG205001	
	550	BSAMG205501	10
	600	BSAMG206001	
	650	BSAMG206501	
	700	BSAMG207001	

**STRUCTURAL - ASSEMBLIES**

**BREMICK™**



## BOLT, NUT & WASHER ASSEMBLY

**Class 8.8 Metric AS 1252 - 1983  
GALVANISED**

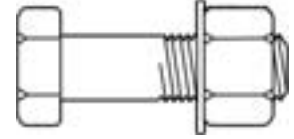

Diameter (mm)	Length (mm)	Product Code	Std. Pack
<b>M24</b>  <b>3.0 mm Pitch</b>	50	BSAMG240501	30
	55	BSAMG240551	
	60	BSAMG240601	
	65	BSAMG240651	
	70	BSAMG240701	
	75	BSAMG240751	
	80	BSAMG240801	
	85	BSAMG240851	
	90	BSAMG240901	25
	100	BSAMG241001	
	110	BSAMG241101	20
	120	BSAMG241201	
	130	BSAMG241301	
	140	BSAMG241401	
	150	BSAMG241501	
	160	BSAMG241601	
	180	BSAMG241801	
	200	BSAMG242001	
	220	BSAMG242201	
	240	BSAMG242401	
	260	BSAMG242601	
	280	BSAMG242801	
	300	BSAMG243001	15
	350	BSAMG243501	
	400	BSAMG244001	10
	450	BSAMG244501	
	500	BSAMG245001	
	550	BSAMG245501	
	600	BSAMG246001	
	650	BSAMG246501	
	700	BSAMG247001	



# BOLT, NUT & WASHER ASSEMBLY



**Class 8.8 Metric AS 1252 - 1983  
GALVANISED**

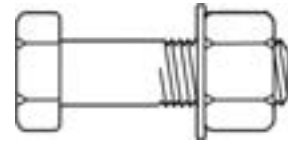

Diameter (mm)	Length (mm)	Product Code	Std. Pack
<b>M30</b>  <b>3.5 mm Pitch</b>	75	BSAMG300751	15
	80	BSAMG300801	
	85	BSAMG300851	
	90	BSAMG300901	
	100	BSAMG301001	
	110	BSAMG301101	10
	120	BSAMG301201	
	130	BSAMG301301	
	140	BSAMG301401	
	150	BSAMG301501	
	160	BSAMG301601	
	180	BSAMG301801	8
	200	BSAMG302001	
	220	BSAMG302201	
	240	BSAMG302401	
	260	BSAMG302601	
	280	BSAMG302801	
	300	BSAMG303001	
<b>M36</b>  <b>4.0 mm Pitch</b>	90	BSAMG360901	8
	100	BSAMG361001	
	120	BSAMG361201	
	130	BSAMG361301	
	140	BSAMG361401	
	150	BSAMG361501	
	160	BSAMG361601	5
	180	BSAMG361801	
	200	BSAMG362001	
	220	BSAMG362201	
	240	BSAMG362401	
	260	BSAMG362601	
300	BSAMG363001		

**STRUCTURAL - ASSEMBLIES**

**BREMICK™**



## STRUCTURAL NUT

**Metric AS 1252 -1983  
BLACK**



Diameter (mm)	Product Code	Std. Pack
M16	NSTMP1600N2	450
M20	NSTMP2000N2	250
M24	NSTMP2400N2	100
M30	NSTMP3000N2	50
M36	NSTMP3600N2	25

**Metric AS 1252 -1983  
GALVANISED**



Diameter (mm)	Product Code	Std. Pack
M16	NSTMG1600N2	450
M20	NSTMG2000N2	250
M24	NSTMG2400N2	100
M30	NSTMG3000N2	50
M36	NSTMG3600N2	25

## STRUCTURAL WASHERS



**AS 1252 - 1983  
BLACK**



Diameter (mm)	Product Code	Std. Pack
M12	WSTMP1200W2	1000
M16	WSTMP1600W2	800
M20	WSTMP2000W2	500
M24	WSTMP2400W2	350
M30	WSTMP3000W2	250
M36	WSTMP3600W2	200

**AS 1252 - 1983  
GALVANISED**



Diameter (mm)	Product Code	Std. Pack
M12	WSTMG1200W2	1000
M16	WSTMG1600W2	800
M20	WSTMG2000W2	500
M24	WSTMG2400W2	350
M30	WSTMG3000W2	250
M36	WSTMG3600W2	200



## LOAD INDICATING WASHERS

**BS 7644 - 1993  
SHERADIZED**



Diameter (mm)	Product Code	Std. Pack
M16	WLIMG1600W2	800
M20	WLIMG2000W2	500
M24	WLIMG2400W2	350
M30	WLIMG3000W2	250

## DIRECT TENSION INDICATING WASHERS (DTI'S)

**ASTM F 959M - AS 4100  
MACHANICALLY GALVANISED**



Diameter (mm)	Product Code	Std. Pack
M16	WLIMG1600W2	800
M20	WLIMG2000W2	500
M24	WLIMG2400W2	350
M30	WLIMG3000W2	250

# HEXAGON HEAD BOLTS & NUTS



## GRADE 5 UNC AS 2465 - 1999 BLACK

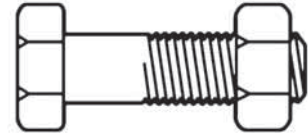

Diameter (Inches)	Length (Inches)	Std. Pack	Product Code Bolt & Nut	Product Code Bolt Only
<b>1/4</b>  <b>20 TPI</b>	1/2	200	B50CP060501	B50CP060502
	3/4		B50CP060751	B50CP060752
	1		B50CP061001	B50CP061002
	1.1/4		B50CP061251	B50CP061252
	1.1/2		B50CP061501	B50CP061502
	1.3/4		B50CP061751	B50CP061752
	2		B50CP062001	B50CP062002
	2.1/4	150	B50CP062251	B50CP062252
	2.1/2		B50CP062501	B50CP062502
	2.3/4		B50CP062751	B50CP062752
	3		B50CP063001	B50CP063002
	3.1/2		B50CP063501	B50CP063502
	4		B50CP064001	B50CP064002
	4.1/2		B50CP064501	B50CP064502
	5	100	B50CP065001	B50CP065002
	5.1/2		B50CP065501	B50CP065502
	6	50	B50CP066001	B50CP066002

## GRADE 5 UNC AS 2465 - 1999 ZINC PLATED

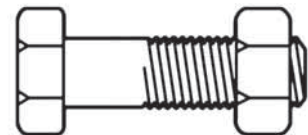

Diameter (Inches)	Length (Inches)	Std. Pack	Product Code Bolt & Nut	Product Code Bolt Only
<b>1/4</b>  <b>20 TPI</b>	1/2	200	B50CZ060501	B50CZ060502
	3/4		B50CZ060751	B50CZ060752
	1		B50CZ061001	B50CZ061002
	1.1/4		B50CZ061251	B50CZ061252
	1.1/2		B50CZ061501	B50CZ061502
	1.3/4		B50CZ061751	B50CZ061752
	2		B50CZ062001	B50CZ062002
	2.1/4	150	B50CZ062251	B50CZ062252
	2.1/2		B50CZ062501	B50CZ062502
	2.3/4		B50CZ062751	B50CZ062752
	3		B50CZ063001	B50CZ063002
	3.1/2		B50CZ063501	B50CZ063502
	4		B50CZ064001	B50CZ064002
	4.1/2		B50CZ064501	B50CZ064502
	5	100	B50CZ065001	B50CZ065002
	5.1/2		B50CZ065501	B50CZ065502
	6	50	B50CZ066001	B50CZ066002

HIGH TENSILE - UNC

**BREMICK**<sup>TM</sup>



# HEXAGON HEAD BOLTS & NUTS

**GRADE 5 UNC AS 2465 - 1999  
BLACK**

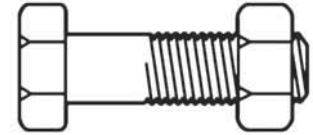

Diameter (Inches)	Length (Inches)	Std. Pack	Product Code Bolt & Nut	Product Code Bolt Only
<b>5/16</b>  <b>18 TPI</b>	1/2	200	B50CP080501	B50CP080502
	3/4		B50CP080751	B50CP080752
	1		B50CP081001	B50CP081002
	1.1/4		B50CP081251	B50CP081252
	1.1/2		B50CP081501	B50CP081502
	1.3/4	150	B50CP081751	B50CP081752
	2		B50CP082001	B50CP082002
	2.1/4		B50CP082251	B50CP082252
	2.1/2		B50CP082501	B50CP082502
	2.3/4	100	B50CP082751	B50CP082752
	3		B50CP083001	B50CP083002
	3.1/2		B50CP083501	B50CP083502
	4		B50CP084001	B50CP084002
	4.1/2		B50CP084501	B50CP084502
	5		B50CP085001	B50CP085002
	5.1/2		B50CP085501	B50CP085502
	6		B50CP086001	B50CP086002

**GRADE 5 UNC AS 2465 - 1999  
ZINC PLATED**

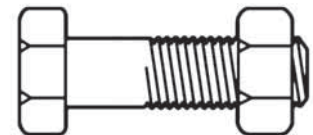

Diameter (Inches)	Length (Inches)	Std. Pack	Product Code Bolt & Nut	Product Code Bolt Only
<b>5/16</b>  <b>18 TPI</b>	1/2	200	B50CZ080501	B50CZ080502
	3/4		B50CZ080751	B50CZ080752
	1		B50CZ081001	B50CZ081002
	1.1/4		B50CZ081251	B50CZ081252
	1.1/2		B50CZ081501	B50CZ081502
	1.3/4	150	B50CZ081751	B50CZ081752
	2		B50CZ082001	B50CZ082002
	2.1/4		B50CZ082251	B50CZ082252
	2.1/2		B50CZ082501	B50CZ082502
	2.3/4	100	B50CZ082751	B50CZ082752
	3		B50CZ083001	B50CZ083002
	3.1/2		B50CZ083501	B50CZ083502
	4		B50CZ084001	B50CZ084002
	4.1/2		B50CZ084501	B50CZ084502
	5		B50CZ085001	B50CZ085002
	5.1/2		B50CZ085501	B50CZ085502
	6		B50CZ086001	B50CZ086002

HIGH TENSILE - UNC

BREMICK™

# HEXAGON HEAD BOLTS & NUTS



## GRADE 5 UNC AS 2465 - 1999 BLACK

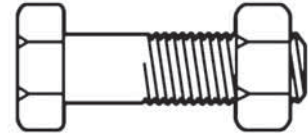

Diameter (Inches)	Length (Inches)	Std. Pack	Product Code Bolt & Nut	Product Code Bolt Only
<b>3/8</b>  <b>16 TPI</b>	1/2	200	B50CP100501	B50CP100502
	3/4		B50CP100751	B50CP100752
	1		B50CP101001	B50CP101002
	1.1/4		B50CP101251	B50CP101252
	1.1/2	150	B50CP101501	B50CP101502
	1.3/4		B50CP101751	B50CP101752
	2	100	B50CP102001	B50CP102002
	2.1/4		B50CP102251	B50CP102252
	2.1/2		B50CP102501	B50CP102502
	2.3/4		B50CP102751	B50CP102752
	3		B50CP103001	B50CP103002
	3.1/2	50	B50CP103501	B50CP103502
	4		B50CP104001	B50CP104002
	4.1/2		B50CP104501	B50CP104502
	5		B50CP105001	B50CP105002
	5.1/2		B50CP105501	B50CP105502
	6		B50CP106001	B50CP106002
	6.1/2		B50CP106501	B50CP106502
	7		B50CP107001	B50CP107002

## GRADE 5 UNC AS 2465 - 1999 ZINC PLATED

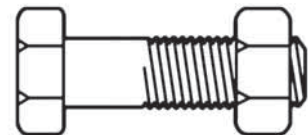

Diameter (Inches)	Length (Inches)	Std. Pack	Product Code Bolt & Nut	Product Code Bolt Only
<b>3/8</b>  <b>16 TPI</b>	1/2	200	B50CZ100501	B50CZ100502
	3/4		B50CZ100751	B50CZ100752
	1		B50CZ101001	B50CZ101002
	1.1/4		B50CZ101251	B50CZ101252
	1.1/2	150	B50CZ101501	B50CZ101502
	1.3/4		B50CZ101751	B50CZ101752
	2	100	B50CZ102001	B50CZ102002
	2.1/4		B50CZ102251	B50CZ102252
	2.1/2		B50CZ102501	B50CZ102502
	2.3/4		B50CZ102751	B50CZ102752
	3		B50CZ103001	B50CZ103002
	3.1/2	50	B50CZ103501	B50CZ103502
	4		B50CZ104001	B50CZ104002
	4.1/2		B50CZ104501	B50CZ104502
	5		B50CZ105001	B50CZ105002
	5.1/2		B50CZ105501	B50CZ105502
	6		B50CZ106001	B50CZ106002
	7		B50CZ107001	B50CZ107002

HIGH TENSILE - UNC

**BREMICK**<sup>TM</sup>



# HEXAGON HEAD BOLTS & NUTS

**GRADE 5 UNC AS 2465 - 1999  
BLACK**

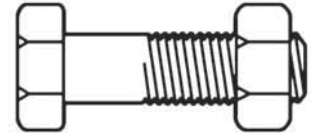

Diameter (Inches)	Length (Inches)	Std. Pack	Product Code Bolt & Nut	Product Code Bolt Only
<b>7/16</b>	3/4	100	B50CP110751	B50CP110752
	1		B50CP111001	B50CP111002
	1.1/4		B50CP111251	B50CP111252
	1.1/2		B50CP111501	B50CP111502
	1.3/4		B50CP111751	B50CP111752
	2		B50CP112001	B50CP112002
	2.1/4	75	B50CP112251	B50CP112252
	2.1/2		B50CP112501	B50CP112502
	2.3/4		B50CP112751	B50CP112752
	3	50	B50CP113001	B50CP113002
	3.1/2		B50CP113501	B50CP113502
	4		B50CP114001	B50CP114002
	4.1/2		B50CP114501	B50CP114502
	5		B50CP115001	B50CP115002
5.1/2	B50CP115501		B50CP115502	
6	B50CP116001		B50CP116002	
6.1/2	B50CP116501	B50CP116502		
7	B50CP117001	B50CP117002		

**GRADE 5 UNC AS 2465 - 1999  
ZINC PLATED**

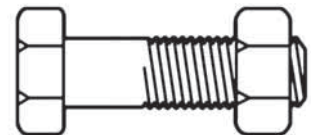

Diameter (Inches)	Length (Inches)	Std. Pack	Product Code Bolt & Nut	Product Code Bolt Only
<b>7/16</b>	3/4	100	B50CZ110751	B50CZ110752
	1		B50CZ111001	B50CZ111002
	1.1/4		B50CZ111251	B50CZ111252
	1.1/2		B50CZ111501	B50CZ111502
	1.3/4		B50CZ111751	B50CZ111752
	2		B50CZ112001	B50CZ112002
	2.1/4	75	B50CZ112251	B50CZ112252
	2.1/2		B50CZ112501	B50CZ112502
	2.3/4		B50CZ112751	B50CZ112752
	3	50	B50CZ113001	B50CZ113002
	3.1/2		B50CZ113501	B50CZ113502
	4		B50CZ114001	B50CZ114002
	4.1/2		B50CZ114501	B50CZ114502
	5		B50CZ115001	B50CZ115002
5.1/2	B50CZ115501		B50CZ115502	
6	B50CZ116001		B50CZ116002	
6.1/2	B50CZ116501	B50CZ116502		
7	B50CZ117001	B50CZ117002		

**HIGH TENSILE - UNC**

**BREMICK™**



# HEXAGON HEAD BOLTS & NUTS



**GRADE 8 UNC AS 2465 - 1999  
BLACK**

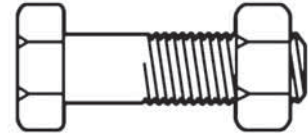

Diameter (Inches)	Length (Inches)	Std. Pack	Product Code Bolt & Nut	Product Code Bolt Only
<b>1/2</b> <b>13 TPI</b>	3/4	75	B80CP120751	B80CP120752
	1		B80CP121001	B80CP121002
	1.1/4		B80CP121251	B80CP121252
	1.1/2		B80CP121501	B80CP121502
	1.3/4		B80CP121751	B80CP121752
	2	50	B80CP122001	B80CP122002
	2.1/4		B80CP122251	B80CP122252
	2.1/2		B80CP122501	B80CP122502
	2.3/4		B80CP122751	B80CP122752
	3	25	B80CP123001	B80CP123002
	3.1/2		B80CP123501	B80CP123502
	4		B80CP124001	B80CP124002
	4.1/2		B80CP124501	B80CP124502
	5		B80CP125001	B80CP125002
	5.1/2		B80CP125501	B80CP125502
	6		B80CP126001	B80CP126002
	6.1/2	20	B80CP126501	B80CP126502
	7		B80CP127001	B80CP127002
	7.1/2		B80CP127501	B80CP127502
	8		B80CP128001	B80CP128002
	8.1/2		B80CP128501	B80CP128502
	9		B80CP129001	B80CP129002
	9.1/2		B80CP129501	B80CP129502
	10		B80CP12X101	B80CP12X102
11	10	B80CP12X111	B80CP12X112	
12		B80CP12X121	B80CP12X122	

**HIGH TENSILE - UNC**

**BREMICK™**



# HEXAGON HEAD BOLTS & NUTS

**GRADE 8 UNC AS 2465 - 1999  
ZINC PLATED**

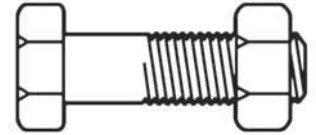

Diameter (Inches)	Length (Inches)	Std. Pack	Product Code Bolt & Nut	Product Code Bolt Only
<b>1/2</b> <b>13 TPI</b>	3/4	75	B80CZ120751	B80CZ120752
	1		B80CZ121001	B80CZ121002
	1.1/4		B80CZ121251	B80CZ121252
	1.1/2		B80CZ121501	B80CZ121502
	1.3/4		B80CZ121751	B80CZ121752
	2	50	B80CZ122001	B80CZ122002
	2.1/4		B80CZ122251	B80CZ122252
	2.1/2		B80CZ122501	B80CZ122502
	2.3/4		B80CZ122751	B80CZ122752
	3	25	B80CZ123001	B80CZ123002
	3.1/2		B80CZ123501	B80CZ123502
	4		B80CZ124001	B80CZ124002
	4.1/2		B80CZ124501	B80CZ124502
	5		B80CZ125001	B80CZ125002
	5.1/2		B80CZ125501	B80CZ125502
	6		B80CZ126001	B80CZ126002
	6.1/2	20	B80CZ126501	B80CZ126502
	7		B80CZ127001	B80CZ127002
	7.1/2		B80CZ127501	B80CZ127502
	8		B80CZ128001	B80CZ128002
	8.1/2		B80CZ128501	B80CZ128502
	9		B80CZ129001	B80CZ129002
	9.1/2		B80CZ129501	B80CZ129502
	10		B80CZ12X101	B80CZ12X102
11	10	B80CZ12X111	B80CZ12X112	
12		B80CZ12X121	B80CZ12X122	

**HIGH TENSILE - UNC**

**BREMICK™**

## HEXAGON HEAD BOLTS & NUTS



**GRADE 8 UNC AS 2465 - 1999  
BLACK**

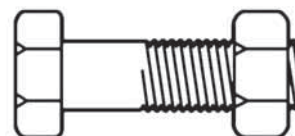

Diameter (Inches)	Length (Inches)	Std. Pack	Product Code Bolt & Nut	Product Code Bolt Only
<b>9/16</b>  <b>12TPI</b>	1	25	B80CP141001	B80CP141002
	1.1/4		B80CP141251	B80CP141252
	1.1/2		B80CP141501	B80CP141502
	1.3/4		B80CP141751	B80CP141752
	2		B80CP142001	B80CP142002
	2.1/4		B80CP142251	B80CP142252
	2.1/2		B80CP142501	B80CP142502
	2.3/4		B80CP142751	B80CP142752
	3		B80CP143001	B80CP143002
	3.1/2		B80CP143501	B80CP143502
	4		B80CP144001	B80CP144002
	4.1/2	15	B80CP144501	B80CP144502
	5		B80CP145001	B80CP145002
	5.1/2		B80CP145501	B80CP145502
	6		B80CP146001	B80CP146002

**GRADE 8 UNC AS 2465 - 1999  
ZINC PLATED**

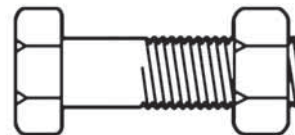

Diameter (Inches)	Length (Inches)	Std. Pack	Product Code Bolt & Nut	Product Code Bolt Only
<b>9/16</b>  <b>12TPI</b>	1	25	B80CZ141001	B80CZ141002
	1.1/4		B80CZ141251	B80CZ141252
	1.1/2		B80CZ141501	B80CZ141502
	1.3/4		B80CZ141751	B80CZ141752
	2		B80CZ142001	B80CZ142002
	2.1/4		B80CZ142251	B80CZ142252
	2.1/2		B80CZ142501	B80CZ142502
	2.3/4		B80CZ142751	B80CZ142752
	3		B80CZ143001	B80CZ143002
	3.1/2		B80CZ143501	B80CZ143502
	4		B80CZ144001	B80CZ144002
	4.1/2	15	B80CZ144501	B80CZ144502
	5		B80CZ145001	B80CZ145002
	5.1/2		B80CZ145501	B80CZ145502
	6		B80CZ146001	B80CZ146002

**HIGH TENSILE - UNC**

**BREMICK™**



# HEXAGON HEAD BOLTS & NUTS

**GRADE 8 UNC AS 2465 - 1999  
BLACK**

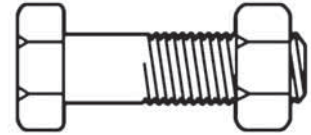

Diameter (Inches)	Length (Inches)	Std. Pack	Product Code Bolt & Nut	Product Code Bolt Only
<b>5/8</b>	1	25	B80CP161001	B80CP161002
	1.1/4		B80CP161251	B80CP161252
	1.1/2		B80CP161501	B80CP161502
	1.3/4		B80CP161751	B80CP161752
	2		B80CP162001	B80CP162002
	2.1/4		B80CP162251	B80CP162252
	2.1/2		B80CP162501	B80CP162502
	2.3/4		B80CP162751	B80CP162752
	3		B80CP163001	B80CP163002
	3.1/2		B80CP163501	B80CP163502
	4		B80CP164001	B80CP164002
	4.1/2	15	B80CP164501	B80CP164502
	5		B80CP165001	B80CP165002
	5.1/2		B80CP165501	B80CP165502
	6		B80CP166001	B80CP166002
	6.1/2		B80CP166501	B80CP166502
	7		B80CP167001	B80CP167002
	7.1/2		B80CP167501	B80CP167502
	8		B80CP168001	B80CP168002
	8.1/2		B80CP168501	B80CP168502
9		B80CP169001	B80CP169002	
9.1/2		B80CP169501	B80CP169502	
10		B80CP16X101	B80CP16X102	
11	10	B80CP16X111	B80CP16X112	
12		B80CP16X121	B80CP16X122	

**5/8**  
**11 TPI**

**HIGH TENSILE - UNC**

**BREMICK™**

# HEXAGON HEAD BOLTS & NUTS



**GRADE 8 UNC AS 2465 - 1999  
ZINC PLATED**

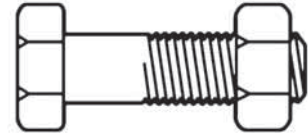

Diameter (Inches)	Length (Inches)	Std. Pack	Product Code Bolt & Nut	Product Code Bolt Only
<b>5/8</b>  <b>11 TPI</b>	1	25	B80CZ161001	B80CZ161002
	1.1/4		B80CZ161251	B80CZ161252
	1.1/2		B80CZ161501	B80CZ161502
	1.3/4		B80CZ161751	B80CZ161752
	2		B80CZ162001	B80CZ162002
	2.1/4		B80CZ162251	B80CZ162252
	2.1/2		B80CZ162501	B80CZ162502
	2.3/4		B80CZ162751	B80CZ162752
	3		B80CZ163001	B80CZ163002
	3.1/2		B80CZ163501	B80CZ163502
	4		B80CZ164001	B80CZ164002
	4.1/2	15	B80CZ164501	B80CZ164502
	5		B80CZ165001	B80CZ165002
	5.1/2		B80CZ165501	B80CZ165502
	6		B80CZ166001	B80CZ166002
	6.1/2		B80CZ166501	B80CZ166502
	7		B80CZ167001	B80CZ167002
	7.1/2		B80CZ167501	B80CZ167502
	8		B80CZ168001	B80CZ168002
	8.1/2		B80CZ168501	B80CZ168502
	9		B80CZ169001	B80CZ169002
	9.1/2		B80CZ169501	B80CZ169502
	10		B80CZ16X101	B80CZ16X102
	11	10	B80CZ16X111	B80CZ16X112
12		B80CZ16X121	B80CZ16X122	

**HIGH TENSILE - UNC**

**BREMICK™**



# HEXAGON HEAD BOLTS & NUTS

**GRADE 8 UNC AS 2465 - 1999  
BLACK**

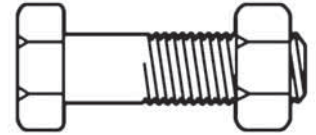

Diameter (Inches)	Length (Inches)	Std. Pack	Product Code Bolt & Nut	Product Code Bolt Only
<b>3/4</b>  <b>10 TPI</b>	1	25	B80CP201001	B80CP201002
	1.1/4		B80CP201251	B80CP201252
	1.1/2		B80CP201501	B80CP201502
	1.3/4		B80CP201751	B80CP201752
	2		B80CP202001	B80CP202002
	2.1/4		B80CP202251	B80CP202252
	2.1/2	20	B80CP202501	B80CP202502
	2.3/4		B80CP202751	B80CP202752
	3		B80CP203001	B80CP203002
	3.1/2		B80CP203501	B80CP203502
	4	10	B80CP204001	B80CP204002
	4.1/2		B80CP204501	B80CP204502
	5		B80CP205001	B80CP205002
	5.1/2		B80CP205501	B80CP205502
	6		B80CP206001	B80CP206002
	6.1/2		B80CP206501	B80CP206502
	7		B80CP207001	B80CP207002
	7.1/2		B80CP207501	B80CP207502
	8		B80CP208001	B80CP208002
	8.1/2	5	B80CP208501	B80CP208502
	9		B80CP209001	B80CP209002
	9.1/2		B80CP209501	B80CP209502
	10		B80CP20X101	B80CP20X101
	11		B80CP20X111	B80CP20X112
12		B80CP20X121	B80CP20X122	

**HIGH TENSILE - UNC**

**BREMICK™**

# HEXAGON HEAD BOLTS & NUTS



**GRADE 8 UNC AS 2465 - 1999  
ZINC PLATED**

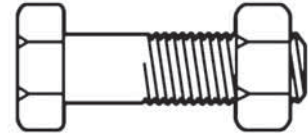

Diameter (Inches)	Length (Inches)	Std. Pack	Product Code Bolt & Nut	Product Code Bolt Only
<b>3/4</b>  <b>10 TPI</b>	1	25	B80CZ201001	B80CZ201002
	1.1/4		B80CZ201251	B80CZ201252
	1.1/2		B80CZ201501	B80CZ201502
	1.3/4		B80CZ201751	B80CZ201752
	2		B80CZ202001	B80CZ202002
	2.1/4		B80CZ202251	B80CZ202252
	2.1/2	20	B80CZ202501	B80CZ202502
	2.3/4		B80CZ202751	B80CZ202752
	3		B80CZ203001	B80CZ203002
	3.1/2		B80CZ203501	B80CZ203502
	4	10	B80CZ204001	B80CZ204002
	4.1/2		B80CZ204501	B80CZ204502
	5		B80CZ205001	B80CZ205002
	5.1/2		B80CZ205501	B80CZ205502
	6		B80CZ206001	B80CZ206002
	6.1/2		B80CZ206501	B80CZ206502
	7		B80CZ207001	B80CZ207002
	7.1/2		B80CZ207501	B80CZ207502
	8		B80CZ208001	B80CZ208002
	8.1/2	5	B80CZ208501	B80CZ208502
	9		B80CZ209001	B80CZ209002
	9.1/2		B80CZ209501	B80CZ209502
	10		B80CZ20X101	B80CZ20X102
	11		B80CZ20X111	B80CZ20X112
12		B80CZ20X121	B80CZ20X122	

**HIGH TENSILE - UNC**

**BREMICK™**



# HEXAGON HEAD BOLTS & NUTS

**GRADE 8 UNC AS 2465 - 1999  
BLACK**

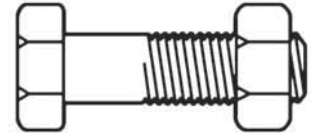

Diameter (Inches)	Length (Inches)	Std. Pack	Product Code Bolt & Nut	Product Code Bolt Only
<b>7/8</b> <b>9 TPI</b>	1.1/2	10	B80CP221501	B80CP221502
	1.3/4		B80CP221751	B80CP221752
	2		B80CP222001	B80CP222002
	2.1/4		B80CP222251	B80CP222252
	2.1/2		B80CP222501	B80CP222502
	2.3/4		B80CP222751	B80CP222752
	3		B80CP223001	B80CP223002
	3.1/2		B80CP223501	B80CP223502
	4		B80CP224001	B80CP224002
	4.1/2		B80CP224501	B80CP224502
	5		B80CP225001	B80CP225002
	5.1/2		B80CP225501	B80CP225502
	6		B80CP226001	B80CP226002
	6.1/2	5	B80CP226501	B80CP226502
	7		B80CP227001	B80CP227002
	7.1/2		B80CP227501	B80CP227502
	8		B80CP228001	B80CP228002
	8.1/2		B80CP228501	B80CP228502
	9		B80CP229001	B80CP229002
	9.1/2		B80CP229501	B80CP229502
	10		B80CP22X101	B80CP22X102
	11		B80CP22X111	B80CP22X112
	12		B80CP22X121	B80CP22X122

**HIGH TENSILE - UNC**

**BREMICK™**



# HEXAGON HEAD BOLTS & NUTS



**GRADE 8 UNC AS 2465 - 1999  
ZINC PLATED**

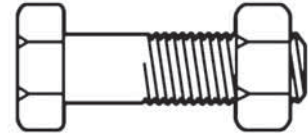

Diameter (Inches)	Length (Inches)	Std. Pack	Product Code Bolt & Nut	Product Code Bolt Only
<b>7/8 9 TPI</b>	1.1/2	10	B80CZ221501	B80CZ221502
	1.3/4		B80CZ221751	B80CZ221752
	2		B80CZ222001	B80CZ222002
	2.1/4		B80CZ222251	B80CZ222252
	2.1/2		B80CZ222501	B80CZ222502
	2.3/4		B80CZ222751	B80CZ222752
	3		B80CZ223001	B80CZ223002
	3.1/2		B80CZ223501	B80CZ223502
	4		B80CZ224001	B80CZ224002
	4.1/2		B80CZ224501	B80CZ224502
	5		B80CZ225001	B80CZ225002
	5.1/2		B80CZ225501	B80CZ225502
	6		B80CZ226001	B80CZ226002
	6.1/2	5	B80CZ226501	B80CZ226502
	7		B80CZ227001	B80CZ227002
	7.1/2		B80CZ227501	B80CZ227502
	8		B80CZ228001	B80CZ228002
	8.1/2		B80CZ228501	B80CZ228502
	9		B80CZ229001	B80CZ229002
	9.1/2		B80CZ229501	B80CZ229502
	10		B80CZ22X101	B80CZ22X102
	11		B80CZ22X111	B80CZ22X112
	12		B80CZ22X121	B80CZ22X122

**HIGH TENSILE - UNC**

**BREMICK™**



## HEXAGON HEAD BOLTS & NUTS

**GRADE 8 UNC AS 2465 - 1999  
BLACK**

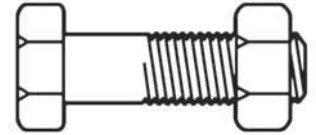

Diameter (Inches)	Length (Inches)	Std. Pack	Product Code Bolt & Nut	Product Code Bolt Only
<b>1 8 TPI</b>	2	5	B80CP242001	B80CP242002
	2.1/4		B80CP242251	B80CP242252
	2.1/2		B80CP242501	B80CP242502
	2.3/4		B80CP242751	B80CP242752
	3		B80CP243001	B80CP243002
	3.1/2		B80CP243501	B80CP243502
	4		B80CP244001	B80CP244002
	4.1/2		B80CP244501	B80CP244502
	5		B80CP245001	B80CP245002
	5.1/2		B80CP245501	B80CP245502
	6		B80CP246001	B80CP246002
	6.1/2		B80CP246501	B80CP246502
	7		B80CP247001	B80CP247002
	7.1/2		B80CP247501	B80CP247502
	8		B80CP248001	B80CP248002
	8.1/2		B80CP248501	B80CP248502
	9		B80CP249001	B80CP249002
	9.1/2		B80CP249501	B80CP249502
10		B80CP24X101	B80CP24X102	
11		B80CP24X111	B80CP24X112	
12		B80CP24X121	B80CP24X122	

**HIGH TENSILE - UNC**

**BREMICK™**

# HEXAGON HEAD BOLTS & NUTS



**GRADE 8 UNC AS 2465 - 1999  
ZINC PLATED**

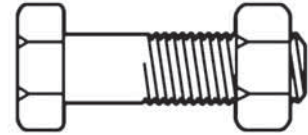

Diameter (Inches)	Length (Inches)	Std. Pack	Product Code Bolt & Nut	Product Code Bolt Only
<b>1 8 TPI</b>	2	5	B80CZ242001	B80CZ242002
	2.1/4		B80CZ242251	B80CZ242252
	2.1/2		B80CZ242501	B80CZ242502
	2.3/4		B80CZ242751	B80CZ242752
	3		B80CZ243001	B80CZ243002
	3.1/2		B80CZ243501	B80CZ243502
	4		B80CZ244001	B80CZ244002
	4.1/2		B80CZ244501	B80CZ244502
	5		B80CZ245001	B80CZ245002
	5.1/2		B80CZ245501	B80CZ245502
	6		B80CZ246001	B80CZ246002
	6.1/2		B80CZ246501	B80CZ246502
	7		B80CZ247001	B80CZ247002
	7.1/2		B80CZ247501	B80CZ247502
	8		B80CZ248001	B80CZ248002
	8.1/2		B80CZ248501	B80CZ248502
	9		B80CZ249001	B80CZ249002
	9.1/2		B80CZ249501	B80CZ249502
10		B80CZ24X101	B80CZ24X102	
11		B80CZ24X111	B80CZ24X112	
12		B80CZ24X121	B80CZ24X122	

**HIGH TENSILE - UNC**

**BREMICK™**



## HEXAGON HEAD BOLTS & NUTS

**GRADE 8 UNC AS 2465 - 1999  
BLACK**

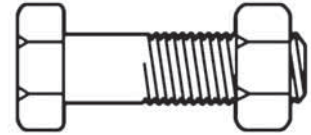

Diameter (Inches)	Length (Inches)	Std. Pack	Product Code Bolt & Nut	Product Code Bolt Only
<b>1.1/8</b> <b>7 TPI</b>	2.1/2	5	B80CP272501	B80CP272502
	3		B80CP273001	B80CP273002
	3.1/2		B80CP273501	B80CP273502
	4		B80CP274001	B80CP274002
	4.1/2		B80CP274501	B80CP274502
	5		B80CP275001	B80CP275002
	5.1/2		B80CP275501	B80CP275502
	6		B80CP276001	B80CP276002
	6.1/2		B80CP276501	B80CP276502
	7		B80CP277001	B80CP277002
	7.1/2		B80CP277501	B80CP277502
	8		B80CP278001	B80CP278002
	8.1/2		B80CP278501	B80CP278502
	9		B80CP279001	B80CP279002
	9.1/2		B80CP279501	B80CP279502
	10		B80CP27X101	B80CP27X102
11		B80CP27X111	B80CP27X112	
12		B80CP27X121	B80CP27X122	

**HIGH TENSILE - UNC**

**BREMICK™**

## HEXAGON HEAD BOLTS & NUTS



### GRADE 8 UNC AS 2465 - 1999 BLACK

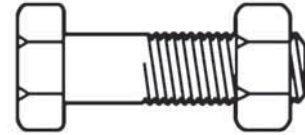

Diameter (Inches)	Length (Inches)	Std. Pack	Product Code Bolt & Nut	Product Code Bolt Only	
<b>1.1/4</b>	3	4	B80CP303001	B80CP303002	
	3.1/2		B80CP303501	B80CP303502	
	4		B80CP304001	B80CP304002	
	4.1/2		B80CP304501	B80CP304502	
	5		B80CP305001	B80CP305002	
	5.1/2		B80CP305501	B80CP305502	
	6		B80CP306001	B80CP306002	
	6.1/2		B80CP306501	B80CP306502	
	7		B80CP307001	B80CP307002	
	<b>7 TPI</b>	7.1/2		B80CP307501	B80CP307502
		8		B80CP308001	B80CP308002
		8.1/2		B80CP308501	B80CP308502
		9		B80CP309001	B80CP309002
		9.1/2		B80CP309501	B80CP309502
		10		B80CP30X101	B80CP30X102
		11		B80CP30X111	B80CP30X112
	12		B80CP30X121	B80CP30X122	

### GRADE 8 UNC AS 2465 - 1999 BLACK

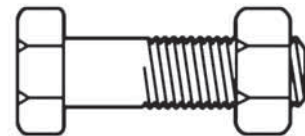

Diameter (Inches)	Length (Inches)	Std. Pack	Product Code Bolt & Nut	Product Code Bolt Only	
<b>1.1/2</b>	3	3	B80CP363001	B80CP363002	
	3.1/2		B80CP363501	B80CP363502	
	4		B80CP364001	B80CP364002	
	4.1/2		B80CP364501	B80CP364502	
	5		B80CP365001	B80CP365002	
	5.1/2		B80CP365501	B80CP365502	
	6		B80CP366001	B80CP366002	
	6.1/2		B80CP366501	B80CP366502	
	7		B80CP367001	B80CP367002	
	<b>6 TPI</b>	7.1/2		B80CP367501	B80CP367502
		8		B80CP368001	B80CP368002
		8.1/2		B80CP368501	B80CP368502
		9		B80CP369001	B80CP369002
		9.1/2		B80CP369501	B80CP369502
		10		B80CP36X101	B80CP36X102
		11		B80CP36X111	B80CP36X112
	12		B80CP36X121	B80CP36X122	

HIGH TENSILE - UNC

**BREMICK**<sup>TM</sup>



## HEXAGON HEAD BOLTS & NUTS

**GRADE 5 UNF AS 2465 - 1999  
BLACK**

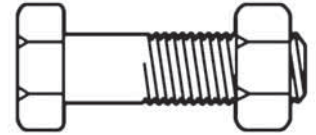

Diameter (Inches)	Length (Inches)	Std. Pack	Product Code Bolt & Nut	Product Code Bolt Only
<b>1/4</b>	1/2	200	B50FP060501	B50FP060502
	3/4		B50FP060751	B50FP060752
	1		B50FP061001	B50FP061002
	1.1/4		B50FP061251	B50FP061252
	1.1/2		B50FP061501	B50FP061502
	1.3/4		B50FP061751	B50FP061752
	2		B50FP062001	B50FP062002
	2.1/4	150	B50FP062251	B50FP062252
	2.1/2		B50FP062501	B50FP062502
	2.3/4		B50FP062751	B50FP062752
	3		B50FP063001	B50FP063002
	3.1/2		B50FP063501	B50FP063502
	4		B50FP064001	B50FP064002
	4.1/2	100	B50FP064501	B50FP064502
	5		B50FP065001	B50FP065002
	5.1/2		B50FP065501	B50FP065502
6	50	B50FP066001	B50FP066002	

**GRADE 5 UNF AS 2465 - 1999  
ZINC PLATED**

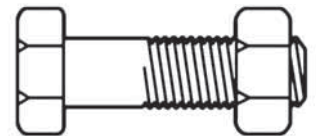

Diameter (Inches)	Length (Inches)	Std. Pack	Product Code Bolt & Nut	Product Code Bolt Only
<b>1/4</b>	1/2	200	B50FZ060501	B50FZ060502
	3/4		B50FZ060751	B50FZ060752
	1		B50FZ061001	B50FZ061002
	1.1/4		B50FZ061251	B50FZ061252
	1.1/2		B50FZ061501	B50FZ061502
	1.3/4		B50FZ061751	B50FZ061752
	2		B50FZ062001	B50FZ062002
	2.1/4	150	B50FZ062251	B50FZ062252
	2.1/2		B50FZ062501	B50FZ062502
	2.3/4		B50FZ062751	B50FZ062752
	3		B50FZ063001	B50FZ063002
	3.1/2		B50FZ063501	B50FZ063502
	4		B50FZ064001	B50FZ064002
	4.1/2	100	B50FZ064501	B50FZ064502
	5		B50FZ065001	B50FZ065002
	5.1/2		B50FZ065501	B50FZ065502
6	50	B50FZ066001	B50FZ066002	

HIGH TENSILE - UNF

BREMICK™

# HEXAGON HEAD BOLTS & NUTS



## GRADE 5 UNF AS 2465 - 1999 BLACK

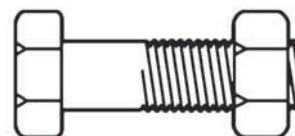

Diameter (Inches)	Length (Inches)	Std. Pack	Product Code Bolt & Nut	Product Code Bolt Only
5/16 24 TPI	1/2	200	B50FP080501	B50FP080502
	3/4		B50FP080751	B50FP080752
	1		B50FP081001	B50FP081002
	1.1/4		B50FP081251	B50FP081252
	1.1/2		B50FP081501	B50FP081502
	1.3/4	150	B50FP081751	B50FP081752
	2		B50FP082001	B50FP082002
	2.1/4		B50FP082251	B50FP082252
	2.1/2		B50FP082501	B50FP082502
	2.3/4	100	B50FP082751	B50FP082752
	3		B50FP083001	B50FP083002
	3.1/2		B50FP083501	B50FP083502
	4		B50FP084001	B50FP084002
	4.1/2		B50FP084501	B50FP084502
	5		B50FP085001	B50FP085002
	5.1/2		B50FP085501	B50FP085502
	6		B50FP086001	B50FP086002

## GRADE 5 UNF AS 2465 - 1999 ZINC PLATED

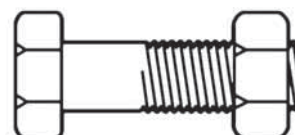

Diameter (Inches)	Length (Inches)	Std. Pack	Product Code Bolt & Nut	Product Code Bolt Only
5/16 24 TPI	1/2	200	B50FZ080501	B50FZ080502
	3/4		B50FZ080751	B50FZ080752
	1		B50FZ081001	B50FZ081002
	1.1/4		B50FZ081251	B50FZ081252
	1.1/2		B50FZ081501	B50FZ081502
	1.3/4	150	B50FZ081751	B50FZ081752
	2		B50FZ082001	B50FZ082002
	2.1/4		B50FZ082251	B50FZ082252
	2.1/2		B50FZ082501	B50FZ082502
	2.3/4	100	B50FZ082751	B50FZ082752
	3		B50FZ083001	B50FZ083002
	3.1/2		B50FZ083501	B50FZ083502
	4		B50FZ084001	B50FZ084002
	4.1/2		B50FZ084501	B50FZ084502
	5		B50FZ085001	B50FZ085002
	5.1/2		B50FZ085501	B50FZ085502
	6		B50FZ086001	B50FZ086002

HIGH TENSILE - UNF

BREMICK™



# HEXAGON HEAD BOLTS & NUTS

**GRADE 5 UNF AS 2465 - 1999  
BLACK**

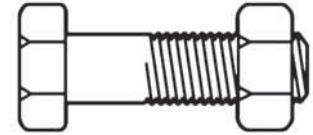

Diameter (Inches)	Length (Inches)	Std. Pack	Product Code Bolt & Nut	Product Code Bolt Only
<b>3/8</b> <b>24 TPI</b>	1/2	200	B50FP100501	B50FP100502
	3/4		B50FP100751	B50FP100752
	1		B50FP101001	B50FP101002
	1.1/4		B50FP101251	B50FP101252
	1.1/2	150	B50FP101501	B50FP101502
	1.3/4		B50FP101751	B50FP101752
	2	100	B50FP102001	B50FP102002
	2.1/4		B50FP102251	B50FP102252
	2.1/2		B50FP102501	B50FP102502
	2.3/4		B50FP102751	B50FP102752
	3		B50FP103001	B50FP103002
	3.1/2	50	B50FP103501	B50FP103502
	4		B50FP104001	B50FP104002
	4.1/2		B50FP104501	B50FP104502
	5		B50FP105001	B50FP105002
	5.1/2		B50FP105501	B50FP105502
	6		B50FP106001	B50FP106002
	6.1/2		B50FP106501	B50FP106502
	7		B50FP107001	B50FP107002

**GRADE 5 UNF AS 2465 - 1999  
ZINC PLATED**

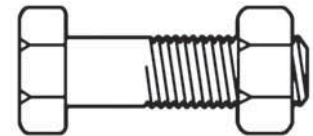

Diameter (Inches)	Length (Inches)	Std. Pack	Product Code Bolt & Nut	Product Code Bolt Only
<b>3/8</b> <b>24 TPI</b>	1/2	200	B50FZ100501	B50FZ100502
	3/4		B50FZ100751	B50FZ100752
	1		B50FZ101001	B50FZ101002
	1.1/4		B50FZ101251	B50FZ101252
	1.1/2	150	B50FZ101501	B50FZ101502
	1.3/4		B50FZ101751	B50FZ101752
	2	100	B50FZ102001	B50FZ102002
	2.1/4		B50FZ102251	B50FZ102252
	2.1/2		B50FZ102501	B50FZ102502
	2.3/4		B50FZ102751	B50FZ102752
	3		B50FZ103001	B50FZ103002
	3.1/2	50	B50FZ103501	B50FZ103502
	4		B50FZ104001	B50FZ104002
	4.1/2		B50FZ104501	B50FZ104502
	5		B50FZ105001	B50FZ105002
	5.1/2		B50FZ105501	B50FZ105502
	6		B50FZ106001	B50FZ106002
	6.1/2		B50FZ106501	B50FZ106502
	7		B50FZ107001	B50FZ107002

HIGH TENSILE - UNF

BREMICK™



# HEXAGON HEAD BOLTS & NUTS



## GRADE 5 UNF AS 2465 - 1999 BLACK

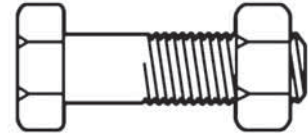

Diameter (Inches)	Length (Inches)	Std. Pack	Product Code Bolt & Nut	Product Code Bolt Only
<b>7/16</b> <b>20 TPI</b>	3/4	100	B50FP110751	B50FP110752
	1		B50FP111001	B50FP111002
	1.1/4		B50FP111251	B50FP111252
	1.1/2		B50FP111501	B50FP111502
	1.3/4		B50FP111751	B50FP111752
	2		B50FP112001	B50FP112002
	2.1/4	75	B50FP112251	B50FP112252
	2.1/2		B50FP112501	B50FP112502
	2.3/4		B50FP112751	B50FP112752
	3		B50FP113001	B50FP113002
	3.1/2		B50FP113501	B50FP113502
	4	50	B50FP114001	B50FP114002
	4.1/2		B50FP114501	B50FP114502
	5		B50FP115001	B50FP115002
	5.1/2		B50FP115501	B50FP115502
	6		B50FP116001	B50FP116002
	6.1/2		B50FP116501	B50FP116502
	7		B50FP117001	B50FP117002

## GRADE 5 UNF AS 2465 - 1999 ZINC PLATED

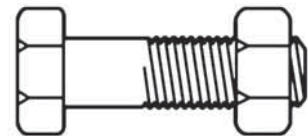

Diameter (Inches)	Length (Inches)	Std. Pack	Product Code Bolt & Nut	Product Code Bolt Only
<b>7/16</b> <b>20 TPI</b>	3/4	100	B50FZ110751	B50FZ110752
	1		B50FZ111001	B50FZ111002
	1.1/4		B50FZ111251	B50FZ111252
	1.1/2		B50FZ111501	B50FZ111502
	1.3/4		B50FZ111751	B50FZ111752
	2		B50FZ112001	B50FZ112002
	2.1/4	75	B50FZ112251	B50FZ112252
	2.1/2		B50FZ112501	B50FZ112502
	2.3/4		B50FZ112751	B50FZ112752
	3		B50FZ113001	B50FZ113002
	3.1/2		B50FZ113501	B50FZ113502
	4	50	B50FZ114001	B50FZ114002
	4.1/2		B50FZ114501	B50FZ114502
	5		B50FZ115001	B50FZ115002
	5.1/2		B50FZ115501	B50FZ115502
	6		B50FZ116001	B50FZ116002
	6.1/2		B50FZ116501	B50FZ116502
	7		B50FZ117001	B50FZ117002

HIGH TENSILE - UNF

**BREMICK**<sup>TM</sup>



# HEXAGON HEAD BOLTS & NUTS

**GRADE 8 UNF AS 2465 - 1999  
ZINC**

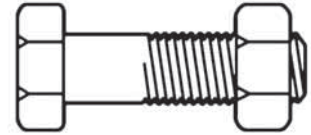

Diameter (Inches)	Length (Inches)	Std. Pack	Product Code Bolt & Nut	Product Code Bolt Only
<b>1/2 20 TPI</b>	3/4	75	B80FP120751	B80FP120752
	1		B80FP121001	B80FP121002
	1.1/4		B80FP121251	B80FP121252
	1.1/2		B80FP121501	B80FP121502
	1.3/4		B80FP121751	B80FP121752
	2	50	B80FP122001	B80FP122002
	2.1/4		B80FP122251	B80FP122252
	2.1/2		B80FP122501	B80FP122502
	2.3/4		B80FP122751	B80FP122752
	3	25	B80FP123001	B80FP123002
	3.1/2		B80FP123501	B80FP123502
	4		B80FP124001	B80FP124002
	4.1/2		B80FP124501	B80FP124502
	5		B80FP125001	B80FP125002
	5.1/2		B80FP125501	B80FP125502
	6		B80FP126001	B80FP126002
	6.1/2	20	B80FP126501	B80FP126502
	7		B80FP127001	B80FP127002
	7.1/2		B80FP127501	B80FP127502
	8		B80FP128001	B80FP128002
8.1/2		B80FP128501	B80FP128502	
9		B80FP129001	B80FP129002	
9.1/2		B80FP129501	B80FP129502	
10		B80FP12X101	B80FP12X102	

**HIGH TENSILE - UNF**

**BREMICK™**

# HEXAGON HEAD BOLTS & NUTS



**GRADE 8 UNF AS 2465 - 1999  
ZINC PLATED**

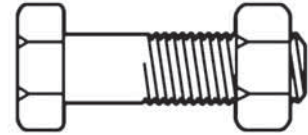

Diameter (Inches)	Length (Inches)	Std. Pack	Product Code Bolt & Nut	Product Code Bolt Only
<b>1/2 20 TPI</b>	3/4	75	B80FZ120751	B80FZ120752
	1		B80FZ121001	B80FZ121002
	1.1/4		B80FZ121251	B80FZ121252
	1.1/2		B80FZ121501	B80FZ121502
	1.3/4		B80FZ121751	B80FZ121752
	2	50	B80FZ122001	B80FZ122002
	2.1/4		B80FZ122251	B80FZ122252
	2.1/2		B80FZ122501	B80FZ122502
	2.3/4		B80FZ122751	B80FZ122752
	3	25	B80FZ123001	B80FZ123002
	3.1/2		B80FZ123501	B80FZ123502
	4		B80FZ124001	B80FZ124002
	4.1/2		B80FZ124501	B80FZ124502
	5		B80FZ125001	B80FZ125002
	5.1/2		B80FZ125501	B80FZ125502
	6		B80FZ126001	B80FZ126002
	6.1/2	20	B80FZ126501	B80FZ126502
	7		B80FZ127001	B80FZ127002
	7.1/2		B80FZ127501	B80FZ127502
	8		B80FZ128001	B80FZ128002
8.1/2		B80FZ128501	B80FZ128502	
9		B80FZ129001	B80FZ129002	
9.1/2		B80FZ129501	B80FZ129502	
10		B80FZ12X101	B80FZ12X102	

**HIGH TENSILE - UNF**

**BREMICK™**



## HEXAGON HEAD BOLTS & NUTS

**GRADE 8 UNF AS 2465 - 1999  
BLACK**

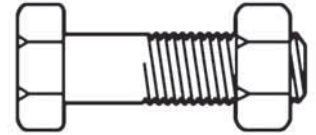

Diameter (Inches)	Length (Inches)	Std. Pack	Product Code Bolt & Nut	Product Code Bolt Only
<b>9/16</b>  <b>18 TPI</b>	1	25	B80FP141001	B80FP141002
	1.1/4		B80FP141251	B80FP141252
	1.1/2		B80FP141501	B80FP141502
	1.3/4		B80FP141751	B80FP141752
	2		B80FP142001	B80FP142002
	2.1/4		B80FP142251	B80FP142252
	2.1/2		B80FP142501	B80FP142502
	2.3/4		B80FP142751	B80FP142752
	3		B80FP143001	B80FP143002
	3.1/2		B80FP143501	B80FP143502
	4		B80FP144001	B80FP144002
	4.1/2	15	B80FP144501	B80FP144502
	5		B80FP145001	B80FP145002
	5.1/2		B80FP145501	B80FP145502
	6		B80FP146001	B80FP146002

**GRADE 8 UNF AS 2465 - 1999  
BLACK**

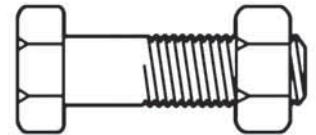

Diameter (Inches)	Length (Inches)	Std. Pack	Product Code Bolt & Nut	Product Code Bolt Only
<b>9/16</b>  <b>18 TPI</b>	1	25	B80FZ141001	B80FZ141002
	1.1/4		B80FZ141251	B80FZ141252
	1.1/2		B80FZ141501	B80FZ141502
	1.3/4		B80FZ141751	B80FZ141752
	2		B80FZ142001	B80FZ142002
	2.1/4		B80FZ142251	B80FZ142252
	2.1/2		B80FZ142501	B80FZ142502
	2.3/4		B80FZ142751	B80FZ142752
	3		B80FZ143001	B80FZ143002
	3.1/2		B80FZ143501	B80FZ143502
	4		B80FZ144001	B80FZ144002
	4.1/2	15	B80FZ144501	B80FZ144502
	5		B80FZ145001	B80FZ145002
	5.1/2		B80FZ145501	B80FZ145502
	6		B80FZ146001	B80FZ146002

HIGH TENSILE - UNF

BREMICK™

# HEXAGON HEAD BOLTS & NUTS



**GRADE 8 UNF AS 2465 - 1999  
BLACK**

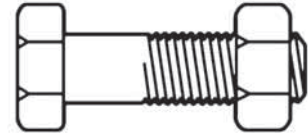

Diameter (Inches)	Length (Inches)	Std. Pack	Product Code Bolt & Nut	Product Code Bolt Only
<b>5/8</b>  <b>18 TPI</b>	1	25	B80FP161001	B80FP161002
	1.1/4		B80FP161251	B80FP161252
	1.1/2		B80FP161501	B80FP161502
	1.3/4		B80FP161751	B80FP161752
	2		B80FP162001	B80FP162002
	2.1/4		B80FP162251	B80FP162252
	2.1/2		B80FP162501	B80FP162502
	2.3/4		B80FP162751	B80FP162752
	3		B80FP163001	B80FP163002
	3.1/2		B80FP163501	B80FP163502
	4		B80FP164001	B80FP164002
	4.1/2	15	B80FP164501	B80FP164502
	5		B80FP165001	B80FP165002
	5.1/2		B80FP165501	B80FP165502
	6		B80FP166001	B80FP166002
	6.1/2		B80FP166501	B80FP166502
	7		B80FP167001	B80FP167002
	7.1/2		B80FP167501	B80FP167502
	8		B80FP168001	B80FP168002
	8.1/2		B80FP168501	B80FP168502
9		B80FP169001	B80FP169002	
9.1/2		B80FP169501	B80FP169502	
10		B80FP16X101	B80FP16X102	

**HIGH TENSILE - UNF**

**BREMICK™**



## HEXAGON HEAD BOLTS & NUTS

**GRADE 8 UNF AS 2465 - 1999  
ZINC PLATED**

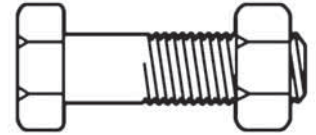

Diameter (Inches)	Length (Inches)	Std. Pack	Product Code Bolt & Nut	Product Code Bolt Only
<b>5/8</b>  <b>18 TPI</b>	1	25	B80FZ161001	B80FZ161002
	1.1/4		B80FZ161251	B80FZ161252
	1.1/2		B80FZ161501	B80FZ161502
	1.3/4		B80FZ161751	B80FZ161752
	2		B80FZ162001	B80FZ162002
	2.1/4		B80FZ162251	B80FZ162252
	2.1/2		B80FZ162501	B80FZ162502
	2.3/4		B80FZ162751	B80FZ162752
	3		B80FZ163001	B80FZ163002
	3.1/2		B80FZ163501	B80FZ163502
	4		B80FZ164001	B80FZ164002
	4.1/2	15	B80FZ164501	B80FZ164502
	5		B80FZ165001	B80FZ165002
	5.1/2		B80FZ165501	B80FZ165502
	6		B80FZ166001	B80FZ166002
	6.1/2		B80FZ166501	B80FZ166502
	7		B80FZ167001	B80FZ167002
	7.1/2		B80FZ167501	B80FZ167502
	8		B80FZ168001	B80FZ168002
	8.1/2		B80FZ168501	B80FZ168502
9		B80FZ169001	B80FZ169002	
9.1/2		B80FZ169501	B80FZ169502	
10		B80FZ16X101	B80FZ16X102	

**HIGH TENSILE - UNF**

**BREMICK™**

# HEXAGON HEAD BOLTS & NUTS



**GRADE 8 UNF AS 2465 - 1999  
BLACK**

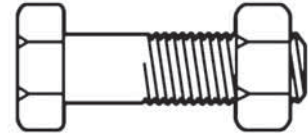

Diameter (Inches)	Length (Inches)	Std. Pack	Product Code Bolt & Nut	Product Code Bolt Only
<b>3/4</b> <b>16 TPI</b>	1	25	B80FP201001	B80FP201002
	1.1/4		B80FP201251	B80FP201252
	1.1/2		B80FP201501	B80FP201502
	1.3/4		B80FP201751	B80FP201752
	2		B80FP202001	B80FP202002
	2.1/4		B80FP202251	B80FP202252
	2.1/2	20	B80FP202501	B80FP202502
	2.3/4		B80FP202751	B80FP202752
	3		B80FP203001	B80FP203002
	3.1/2		B80FP203501	B80FP203502
	4	10	B80FP204001	B80FP204002
	4.1/2		B80FP204501	B80FP204502
	5		B80FP205001	B80FP205002
	5.1/2		B80FP205501	B80FP205502
	6		B80FP206001	B80FP206002
	6.1/2		B80FP206501	B80FP206502
	7		B80FP207001	B80FP207002
	7.1/2		B80FP207501	B80FP207502
	8		B80FP208001	B80FP208002
	8.1/2	5	B80FP208501	B80FP208502
9		B80FP209001	B80FP209002	
9.1/2		B80FP209501	B80FP209502	
10		B80FP20X101	B80FP20X102	

**HIGH TENSILE - UNF**

**BREMICK™**



## HEXAGON HEAD BOLTS & NUTS

**GRADE 8 UNF AS 2465 - 1999  
ZINC PLATED**

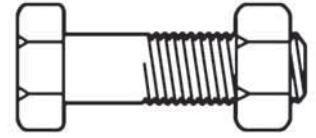

Diameter (Inches)	Length (Inches)	Std. Pack	Product Code Bolt & Nut	Product Code Bolt Only
<b>3/4</b> <b>16 TPI</b>	1	25	B80FZ201001	B80FZ201002
	1.1/4		B80FZ201251	B80FZ201252
	1.1/2		B80FZ201501	B80FZ201502
	1.3/4		B80FZ201751	B80FZ201752
	2		B80FZ202001	B80FZ202002
	2.1/4		B80FZ202251	B80FZ202252
	2.1/2	20	B80FZ202501	B80FZ202502
	2.3/4		B80FZ202751	B80FZ202752
	3		B80FZ203001	B80FZ203002
	3.1/2		B80FZ203501	B80FZ203502
	4	10	B80FZ204001	B80FZ204002
	4.1/2		B80FZ204501	B80FZ204502
	5		B80FZ205001	B80FZ205002
	5.1/2		B80FZ205501	B80FZ205502
	6		B80FZ206001	B80FZ206002
	6.1/2		B80FZ206501	B80FZ206502
	7		B80FZ207001	B80FZ207002
	7.1/2		B80FZ207501	B80FZ207502
	8		B80FZ208001	B80FZ208002
	8.1/2	5	B80FZ208501	B80FZ208502
9		B80FZ209001	B80FZ209002	
9.1/2		B80FZ209501	B80FZ209502	
10		B80FZ20X101	B80FZ20X102	

**HIGH TENSILE - UNF**

**BREMICK™**



# HEXAGON HEAD BOLTS & NUTS



**GRADE 8 UNF AS 2465 - 1999  
BLACK**

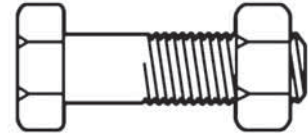

Diameter (Inches)	Length (Inches)	Std. Pack	Product Code Bolt & Nut	Product Code Bolt Only
<b>7/8</b> <b>14 TPI</b>	1.1/2	10	B80FP221501	B80FP221502
	1.3/4		B80FP221751	B80FP221752
	2		B80FP222001	B80FP222002
	2.1/4		B80FP222251	B80FP222252
	2.1/2		B80FP222501	B80FP222502
	2.3/4		B80FP222751	B80FP222752
	3		B80FP223001	B80FP223002
	3.1/2		B80FP223501	B80FP223502
	4		B80FP224001	B80FP224002
	4.1/2		B80FP224501	B80FP224502
	5		B80FP225001	B80FP225002
	5.1/2		B80FP225501	B80FP225502
	6		B80FP226001	B80FP226002
	6.1/2	5	B80FP226501	B80FP226502
	7		B80FP227001	B80FP227002
	7.1/2		B80FP227501	B80FP227502
	8		B80FP228001	B80FP228002
	8.1/2		B80FP228501	B80FP228502
	9		B80FP229001	B80FP229002
	9.1/2		B80FP229501	B80FP229502
10		B80FP22X101	B80FP22X102	

**HIGH TENSILE - UNF**

**BREMICK™**



## HEXAGON HEAD BOLTS & NUTS

**GRADE 8 UNF AS 2465 - 1999  
ZINC PLATED**

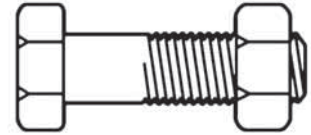

Diameter (Inches)	Length (Inches)	Std. Pack	Product Code Bolt & Nut	Product Code Bolt Only
<b>7/8</b> <b>14 TPI</b>	1.1/2	10	B80FZ221501	B80FZ221502
	1.3/4		B80FZ221751	B80FZ221752
	2		B80FZ222001	B80FZ222002
	2.1/4		B80FZ222251	B80FZ222252
	2.1/2		B80FZ222501	B80FZ222502
	2.3/4		B80FZ222751	B80FZ222752
	3		B80FZ223001	B80FZ223002
	3.1/2		B80FZ223501	B80FZ223502
	4		B80FZ224001	B80FZ224002
	4.1/2		B80FZ224501	B80FZ224502
	5		B80FZ225001	B80FZ225002
	5.1/2		B80FZ225501	B80FZ225502
	6		B80FZ226001	B80FZ226002
	6.1/2	5	B80FZ226501	B80FZ226502
	7		B80FZ227001	B80FZ227002
	7.1/2		B80FZ227501	B80FZ227502
	8		B80FZ228001	B80FZ228002
	8.1/2		B80FZ228501	B80FZ228502
	9		B80FZ229001	B80FZ229002
	9.1/2		B80FZ229501	B80FZ229502
10		B80FZ22X101	B80FZ22X102	

**HIGH TENSILE - UNF**

**BREMICK™**

# HEXAGON HEAD BOLTS & NUTS



**GRADE 8 UNF AS 2465 - 1999  
BLACK**

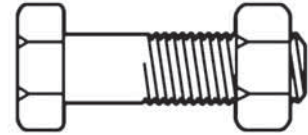

Diameter (Inches)	Length (Inches)	Std. Pack	Product Code Bolt & Nut	Product Code Bolt Only
<b>1 14 TPI</b>	2	5	B80FP242001	B80FP242002
	2.1/4		B80FP242251	B80FP242252
	2.1/2		B80FP242501	B80FP242502
	2.3/4		B80FP242751	B80FP242752
	3		B80FP243001	B80FP243002
	3.1/2		B80FP243501	B80FP243502
	4		B80FP244001	B80FP244002
	4.1/2		B80FP244501	B80FP244502
	5		B80FP245001	B80FP245002
	5.1/2		B80FP245501	B80FP245502
	6		B80FP246001	B80FP246002
	6.1/2		B80FP246501	B80FP246502
	7		B80FP247001	B80FP247002
	7.1/2		B80FP247501	B80FP247502
	8		B80FP248001	B80FP248002
	8.1/2		B80FP248501	B80FP248502
	9		B80FP249001	B80FP249002
	9.1/2		B80FP249501	B80FP249502
10		B80FP24X101	B80FP24X102	
11		B80FP24X111	B80FP24X112	
12		B80FP24X121	B80FP24X122	

**HIGH TENSILE - UNF**

**BREMICK™**



## HEXAGON HEAD BOLTS & NUTS

**GRADE 8 UNF AS 2465 - 1999  
ZINC PLATED**

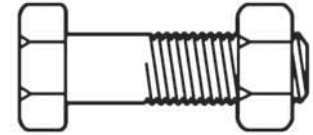

Diameter (Inches)	Length (Inches)	Std. Pack	Product Code Bolt & Nut	Product Code Bolt Only
<b>1 14 TPI</b>	2	5	B80FZ242001	B80FZ242002
	2.1/4		B80FZ242251	B80FZ242252
	2.1/2		B80FZ242501	B80FZ242502
	2.3/4		B80FZ242751	B80FZ242752
	3		B80FZ243001	B80FZ243002
	3.1/2		B80FZ243501	B80FZ243502
	4		B80FZ244001	B80FZ244002
	4.1/2		B80FZ244501	B80FZ244502
	5		B80FZ245001	B80FZ245002
	5.1/2		B80FZ245501	B80FZ245502
	6		B80FZ246001	B80FZ246002
	6.1/2		B80FZ246501	B80FZ246502
	7		B80FZ247001	B80FZ247002
	7.1/2		B80FZ247501	B80FZ247502
	8		B80FZ248001	B80FZ248002
	8.1/2		B80FZ248501	B80FZ248502
	9		B80FZ249001	B80FZ249002
	9.1/2		B80FZ249501	B80FZ249502
	10		B80FZ24X101	B80FZ24X102
	11		B80FZ24X111	B80FZ24X112
12		B80FZ24X121	B80FZ24X122	

**HIGH TENSILE - UNF**

**BREMICK™**

## HEXAGON HEAD BOLTS & NUTS



**Class 8.8 AS 1110 - 2000 / AS 1112 - 2000  
BLACK**

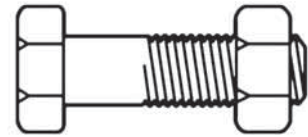

Diameter (mm)	Length (mm)	Std. Pack	Product Code Bolt & Nut	Product Code Bolt Only
<b>M6</b>  <b>1.0 mm Pitch</b>	12	200	B88MP060121	B88MP060122
	16		B88MP060161	B88MP060162
	20		B88MP060201	B88MP060202
	25		B88MP060251	B88MP060252
	30		B88MP060301	B88MP060302
	35		B88MP060351	B88MP060352
	40		B88MP060401	B88MP060402
	45		B88MP060451	B88MP060452
	50		B88MP060501	B88MP060502
	55	150	B88MP060551	B88MP060552
	60		B88MP060601	B88MP060602
	65		B88MP060651	B88MP060652
	70		B88MP060701	B88MP060702
	75		B88MP060751	B88MP060752
	80		B88MP060801	B88MP060802

**Class 8.8 AS 1110 - 2000 / AS 1112 - 2000  
ZINC PLATED**

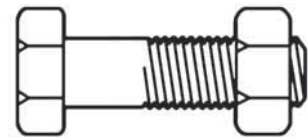

Diameter (mm)	Length (mm)	Std. Pack	Product Code Bolt & Nut	Product Code Bolt Only
<b>M6</b>  <b>1.0 mm Pitch</b>	12	200	B88MZ060121	B88MZ060122
	16		B88MZ060161	B88MZ060162
	20		B88MZ060201	B88MZ060202
	25		B88MZ060251	B88MZ060252
	30		B88MZ060301	B88MZ060302
	35		B88MZ060351	B88MZ060352
	40		B88MZ060401	B88MZ060402
	45		B88MZ060451	B88MZ060452
	50		B88MZ060501	B88MZ060502
	55	150	B88MZ060551	B88MZ060552
	60		B88MZ060601	B88MZ060602
	65		B88MZ060651	B88MZ060652
	70		B88MZ060701	B88MZ060702
	75		B88MZ060751	B88MZ060752
	80		B88MZ060801	B88MZ060802

**HIGH TENSILE - METRIC**

**BREMICK™**



## HEXAGON HEAD BOLTS & NUTS

Class 8.8 AS 1110 - 2000 / AS 1112 - 2000  
BLACK

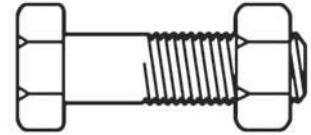

Diameter (mm)	Length (mm)	Std. Pack	Product Code Bolt & Nut	Product Code Bolt Only
<b>M8</b>  <b>1.25 mm Pitch</b>	12	200	B88MP080121	B88MP080122
	16		B88MP080161	B88MP080162
	20		B88MP080201	B88MP080202
	25		B88MP080251	B88MP080252
	30		B88MP080301	B88MP080302
	35		B88MP080351	B88MP080352
	40		B88MP080401	B88MP080402
	45	150	B88MP080451	B88MP080452
	50		B88MP080501	B88MP080502
	55		B88MP080551	B88MP080552
	60		B88MP080601	B88MP080602
	65		B88MP080651	B88MP080652
	70	100	B88MP080701	B88MP080702
	75		B88MP080751	B88MP080752
	80		B88MP080801	B88MP080802
	85		B88MP080851	B88MP080852
	90		B88MP080901	B88MP080902
	95		B88MP080951	B88MP080952
	100		B88MP081001	B88MP081002
	110		B88MP081101	B88MP081102
120		B88MP081201	B88MP081202	
130		B88MP081301	B88MP081302	

HIGH TENSILE - METRIC

**BREMICK**<sup>TM</sup>

## HEXAGON HEAD BOLTS & NUTS



**Class 8.8 AS 1110 - 2000 / AS 1112 - 2000  
ZINC PLATED**

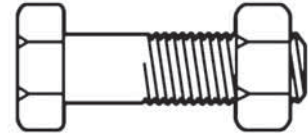

Diameter (mm)	Length (mm)	Std. Pack	Product Code Bolt & Nut	Product Code Bolt Only
<b>M8</b>  <b>1.25 mm Pitch</b>	12	200	B88MZ080121	B88MZ080122
	16		B88MZ080161	B88MZ080162
	20		B88MZ080201	B88MZ080202
	25		B88MZ080251	B88MZ080252
	30		B88MZ080301	B88MZ080302
	35		B88MZ080351	B88MZ080352
	40		B88MZ080401	B88MZ080402
	45	150	B88MZ080451	B88MZ080452
	50		B88MZ080501	B88MZ080502
	55		B88MZ080551	B88MZ080552
	60		B88MZ080601	B88MZ080602
	65		B88MZ080651	B88MZ080652
	70	100	B88MZ080701	B88MZ080702
	75		B88MZ080751	B88MZ080752
	80		B88MZ080801	B88MZ080802
	85		B88MZ080851	B88MZ080852
	90		B88MZ080901	B88MZ080902
	95		B88MZ080951	B88MZ080952
	100		B88MZ081001	B88MZ081002
	110		B88MZ081101	B88MZ081102
120		B88MZ081201	B88MZ081202	
130		B88MZ081301	B88MZ081302	

**HIGH TENSILE - METRIC**

**BREMICK™**



## HEXAGON HEAD BOLTS & NUTS

**Class 8.8 AS 1110 - 2000 / AS 1112 - 2000  
BLACK**

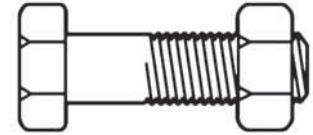

Diameter (mm)	Length (mm)	Std. Pack	Product Code Bolt & Nut	Product Code Bolt Only
<b>M10</b>  <b>1.5 mm Pitch</b>	12	150	B88MP100121	B88MP100122
	16		B88MP100161	B88MP100162
	20		B88MP100201	B88MP100202
	25		B88MP100251	B88MP100252
	30		B88MP100301	B88MP100302
	35		B88MP100351	B88MP100352
	40		B88MP100401	B88MP100402
	45		B88MP100451	B88MP100452
	50	75	B88MP100501	B88MP100502
	55		B88MP100551	B88MP100552
	60		B88MP100601	B88MP100602
	65		B88MP100651	B88MP100652
	70		B88MP100701	B88MP100702
	75		B88MP100751	B88MP100752
	80		B88MP100801	B88MP100802
	85		B88MP100851	B88MP100852
	90	50	B88MP100901	B88MP100902
	100		B88MP101001	B88MP101001
	110		B88MP101101	B88MP101102
	120		B88MP101201	B88MP101202
130		B88MP101301	B88MP101302	
140		B88MP101401	B88MP101402	
150		B88MP101501	B88MP101502	
160		B88MP101601	B88MP101602	
170		B88MP101701	B88MP101702	
180	25	B88MP101801	B88MP101802	
190		B88MP101901	B88MP101902	
200		B88MP102001	B88MP102002	

**HIGH TENSILE - METRIC**

**BREMICK™**



## HEXAGON HEAD BOLTS & NUTS



**Class 8.8 AS 1110 - 2000 / AS 1112 - 2000  
ZINC PLATED**

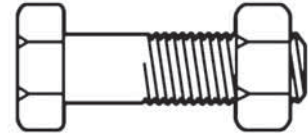

Diameter (mm)	Length (mm)	Std. Pack	Product Code Bolt & Nut	Product Code Bolt Only
<b>M10</b>  <b>1.5 mm Pitch</b>	12	150	B88MZ100121	B88MZ100122
	16		B88MZ100161	B88MZ100162
	20		B88MZ100201	B88MZ100202
	25		B88MZ100251	B88MZ100252
	30		B88MZ100301	B88MZ100302
	35		B88MZ100351	B88MZ100352
	40		B88MZ100401	B88MZ100402
	45		B88MZ100451	B88MZ100452
	50	75	B88MZ100501	B88MZ100502
	55		B88MZ100551	B88MZ100552
	60		B88MZ100601	B88MZ100602
	65		B88MZ100651	B88MZ100652
	70		B88MZ100701	B88MZ100702
	75		B88MZ100751	B88MZ100752
	80		B88MZ100801	B88MZ100802
	85		B88MZ100851	B88MZ100852
	90	50	B88MZ100901	B88MZ100902
	100		B88MZ101001	B88MZ101002
	110		B88MZ101101	B88MZ101102
	120		B88MZ101201	B88MZ101202
	130		B88MZ101301	B88MZ101302
	140		B88MZ101401	B88MZ101402
	150		B88MZ101501	B88MZ101502
	160		B88MZ101601	B88MZ101602
	170		B88MZ101701	B88MZ101702
	180	25	B88MZ101801	B88MZ101802
	190		B88MZ101901	B88MZ101902
	200		B88MZ102001	B88MZ102002

**HIGH TENSILE - METRIC**

**BREMICK™**



## HEXAGON HEAD BOLTS & NUTS

**Class 8.8 AS 1110 - 2000 / AS 1112 - 2000  
BLACK**

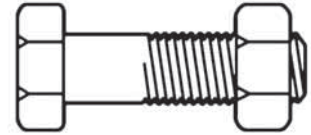

Diameter (mm)	Length (mm)	Std. Pack	Product Code Bolt & Nut	Product Code Bolt Only
<b>M12</b>  <b>1.75 mm Pitch</b>	20	75	B88MP120201	B88MP120202
	25		B88MP120251	B88MP120252
	30		B88MP120301	B88MP120302
	35		B88MP120351	B88MP120352
	40		B88MP120401	B88MP120402
	45		B88MP120451	B88MP120452
	50	50	B88MP120501	B88MP120502
	55		B88MP120551	B88MP120552
	60		B88MP120601	B88MP120602
	65		B88MP120651	B88MP120652
	70		B88MP120701	B88MP120702
	75		B88MP120751	B88MP120752
	80	25	B88MP120801	B88MP120802
	85		B88MP120851	B88MP120852
	90		B88MP120901	B88MP120902
	100		B88MP121001	B88MP121002
	110		B88MP121101	B88MP121102
	120		B88MP121201	B88MP121202
	130		B88MP121301	B88MP121302
	140		B88MP121401	B88MP121402
150		B88MP121501	B88MP121502	
160	20	B88MP121601	B88MP121602	
170		B88MP121701	B88MP121702	
180		B88MP121801	B88MP121802	
190		B88MP121901	B88MP121902	
200		B88MP122001	B88MP122002	

**HIGH TENSILE - METRIC**

**BREMICK™**

# HEXAGON HEAD BOLTS & NUTS



**Class 8.8 AS 1110 - 2000 / AS 1112 - 2000  
ZINC PLATED**

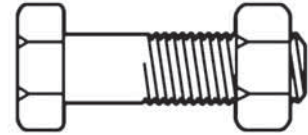

Diameter (mm)	Length (mm)	Std. Pack	Product Code Bolt & Nut	Product Code Bolt Only
<b>M12</b>  <b>1.75 mm Pitch</b>	20	75	B88MZ120201	B88MZ120202
	25		B88MZ120251	B88MZ120252
	30		B88MZ120301	B88MZ120302
	35		B88MZ120351	B88MZ120352
	40		B88MZ120401	B88MZ120402
	45		B88MZ120451	B88MZ120452
	50	50	B88MZ120501	B88MZ120502
	55		B88MZ120551	B88MZ120552
	60		B88MZ120601	B88MZ120602
	65		B88MZ120651	B88MZ120652
	70		B88MZ120701	B88MZ120702
	75		B88MZ120751	B88MZ120752
	80	25	B88MZ120801	B88MZ120802
	85		B88MZ120851	B88MZ120852
	90		B88MZ120901	B88MZ120902
	100		B88MZ121001	B88MZ121002
	110		B88MZ121101	B88MZ121102
	120		B88MZ121201	B88MZ121202
	130		B88MZ121301	B88MZ121302
	140		B88MZ121401	B88MZ121402
150		B88MZ121501	B88MZ121502	
160	20	B88MZ121601	B88MZ121602	
170		B88MZ121701	B88MZ121702	
180		B88MZ121801	B88MZ121802	
190		B88MZ121901	B88MZ121902	
200		B88MZ122001	B88MZ122002	

**Class 8.8 AS 1110 - 2000 / AS 1112 - 2000  
GALVANISED**

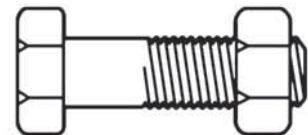

Diameter (mm)	Length (mm)	Product Code	Std. Pack
<b>M12</b>  <b>1.75 mm Pitch</b>	30	75	B88MG120301
	40		B88MG120401
	50	50	B88MG120501

**HIGH TENSILE - METRIC**

**BREMICK™**



# HEXAGON HEAD BOLTS & NUTS

**Class 8.8 AS 1110 - 2000 / AS 1112 - 2000  
BLACK**

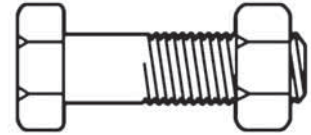

Diameter (mm)	Length (mm)	Std. Pack	Product Code Bolt & Nut	Product Code Bolt Only
<b>M16</b>  <b>2.0 mm Pitch</b>	25	25	B88MP160251	B88MP160252
	30		B88MP160301	B88MP160302
	35		B88MP160351	B88MP160352
	40		B88MP160401	B88MP160402
	45		B88MP160451	B88MP160452
	50		B88MP160501	B88MP160502
	55		B88MP160551	B88MP160552
	60		B88MP160601	B88MP160602
	65		B88MP160651	B88MP160652
	70		B88MP160701	B88MP160702
	75		B88MP160751	B88MP160752
	80		B88MP160801	B88MP160802
	85		B88MP160851	B88MP160852
	90		B88MP160901	B88MP160902
	100		B88MP161001	B88MP161002
	110	15	B88MP161101	B88MP161102
	120		B88MP161201	B88MP161202
	130		B88MP161301	B88MP161302
	140		B88MP161401	B88MP161402
	150		B88MP161501	B88MP161502
	160		B88MP161601	B88MP161602
	170		B88MP161701	B88MP161702
	180		B88MP161801	B88MP161802
	190		B88MP161901	B88MP161902
	200		B88MP162001	B88MP162002
210	10	B88MP162101	B88MP162102	
220		B88MP162201	B88MP162202	
230		B88MP162301	B88MP162302	
240		B88MP162401	B88MP162402	
250		B88MP162501	B88MP162502	

**HIGH TENSILE - METRIC**

**BREMICK™**

# HEXAGON HEAD BOLTS & NUTS



**Class 8.8 AS 1110 - 2000 / AS 1112 - 2000  
ZINC PLATED**

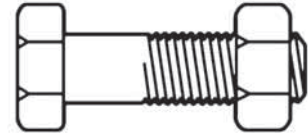

Diameter (mm)	Length (mm)	Std. Pack	Product Code Bolt & Nut	Product Code Bolt Only
<b>M16</b>  <b>2.0 mm Pitch</b>	25	25	B88MZ160251	B88MZ160252
	30		B88MZ160301	B88MZ160302
	35		B88MZ160351	B88MZ160352
	40		B88MZ160401	B88MZ160402
	45		B88MZ160451	B88MZ160452
	50		B88MZ160501	B88MZ160502
	55		B88MZ160551	B88MZ160552
	60		B88MZ160601	B88MZ160602
	65		B88MZ160651	B88MZ160652
	70		B88MZ160701	B88MZ160702
	75		B88MZ160751	B88MZ160752
	80		B88MZ160801	B88MZ160802
	85		B88MZ160851	B88MZ160852
	90		B88MZ160901	B88MZ160902
	100		B88MZ161001	B88MZ161002
	110	15	B88MZ161101	B88MZ161102
	120		B88MZ161201	B88MZ161202
	130		B88MZ161301	B88MZ161302
	140		B88MZ161401	B88MZ161402
	150		B88MZ161501	B88MZ161502
	160		B88MZ161601	B88MZ161602
	170		B88MZ161701	B88MZ161702
	180		B88MZ161801	B88MZ161802
	190		B88MZ161901	B88MZ161902
	200		B88MZ162001	B88MZ162002
	210	10	B88MZ162101	B88MZ162102
	220		B88MZ162201	B88MZ162202
	230		B88MZ162301	B88MZ162302
	240		B88MZ162401	B88MZ162402
	250		B88MZ162501	B88MZ162502

**HIGH TENSILE - METRIC**

**BREMICK™**



## HEXAGON HEAD BOLTS & NUTS

Class 8.8 AS 1110 - 2000 / AS 1112 - 2000  
BLACK

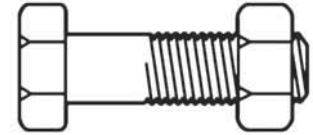

Diameter (mm)	Length (mm)	Std. Pack	Product Code Bolt & Nut	Product Code Bolt Only
M20 2.5 mm Pitch	40	25	B88MP200401	B88MP200402
	45		B88MP200451	B88MP200452
	50		B88MP200501	B88MP200502
	55		B88MP200551	B88MP200552
	60		B88MP200601	B88MP200602
	65	20	B88MP200651	B88MP200652
	70		B88MP200701	B88MP200702
	75		B88MP200751	B88MP200752
	80		B88MP200801	B88MP200802
	85		B88MP200851	B88MP200852
	90		B88MP200901	B88MP200902
	100	10	B88MP201001	B88MP201002
	110		B88MP201101	B88MP201102
	120		B88MP201201	B88MP201202
	130		B88MP201301	B88MP201302
	140		B88MP201401	B88MP201402
	150		B88MP201501	B88MP201502
	160		B88MP201601	B88MP201602
	170		B88MP201701	B88MP201702
	180		B88MP201801	B88MP201802
190		B88MP201901	B88MP201902	
200		B88MP202001	B88MP202002	
210	5	B88MP202101	B88MP202102	
220		B88MP202201	B88MP202202	
230		B88MP202301	B88MP202302	
240		B88MP202401	B88MP202402	
250		B88MP202501	B88MP202502	

HIGH TENSILE - METRIC

BREMICK™

## HEXAGON HEAD BOLTS & NUTS



**Class 8.8 AS 1110 - 2000 / AS 1112 - 2000  
ZINC PLATED**

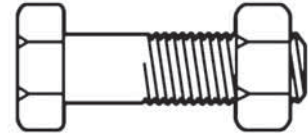

Diameter (mm)	Length (mm)	Std. Pack	Product Code Bolt & Nut	Product Code Bolt Only
<b>M20</b>  <b>2.5 mm Pitch</b>	40	25	B88MZ200401	B88MZ200402
	45		B88MZ200451	B88MZ200452
	50		B88MZ200501	B88MZ200502
	55		B88MZ200551	B88MZ200552
	60		B88MZ200601	B88MZ200602
	65	20	B88MZ200651	B88MZ200652
	70		B88MZ200701	B88MZ200702
	75		B88MZ200751	B88MZ200752
	80		B88MZ200801	B88MZ200802
	85		B88MZ200851	B88MZ200852
	90		B88MZ200901	B88MZ200902
	100	10	B88MZ201001	B88MZ201002
	110		B88MZ201101	B88MZ201102
	120		B88MZ201201	B88MZ201202
	130		B88MZ201301	B88MZ201302
	140		B88MZ201401	B88MZ201402
	150		B88MZ201501	B88MZ201502
	160		B88MZ201601	B88MZ201602
	170		B88MZ201701	B88MZ201702
	180		B88MZ201801	B88MZ201802
190		B88MZ201901	B88MZ201902	
200		B88MZ202001	B88MZ202002	
210	5	B88MZ202101	B88MZ202102	
220		B88MZ202201	B88MZ202202	
230		B88MZ202301	B88MZ202302	
240		B88MZ202401	B88MZ202402	
250		B88MZ202501	B88MZ202502	

**HIGH TENSILE - METRIC**

**BREMICK™**



## HEXAGON HEAD BOLTS & NUTS

Class 8.8 AS 1110 - 2000 / AS 1112 - 2000  
BLACK

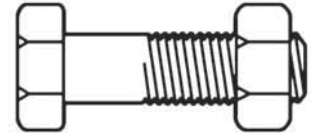

Diameter (mm)	Length (mm)	Std. Pack	Product Code Bolt & Nut	Product Code Bolt Only
<b>M24</b> <b>3.0 mm Pitch</b>	50	5	B88MP240501	B88MP240502
	55		B88MP240551	B88MP240552
	60		B88MP240601	B88MP240602
	65		B88MP240651	B88MP240652
	70		B88MP240701	B88MP240702
	75		B88MP240751	B88MP240752
	80		B88MP240801	B88MP240802
	90		B88MP240901	B88MP240902
	100		B88MP241001	B88MP241002
	110		B88MP241101	B88MP241102
	120		B88MP241201	B88MP241202
	130		B88MP241301	B88MP241302
	140		B88MP241401	B88MP241402
	150		B88MP241501	B88MP241502
	160		B88MP241601	B88MP241602
	170		B88MP241701	B88MP241702
	180		B88MP241801	B88MP241802
	190		B88MP241901	B88MP241902
	200		B88MP242001	B88MP242002
	210		B88MP242101	B88MP242102
220		B88MP242201	B88MP242202	
230		B88MP242301	B88MP242302	
240		B88MP242401	B88MP242402	
250		B88MP242501	B88MP242502	

HIGH TENSILE - METRIC

**BREMICK**<sup>TM</sup>



## HEXAGON HEAD BOLTS & NUTS



**Class 8.8 AS 1110 - 2000 / AS 1112 - 2000  
ZINC PLATED**

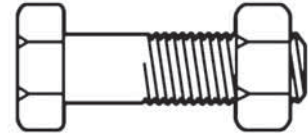

Diameter (mm)	Length (mm)	Std. Pack	Product Code Bolt & Nut	Product Code Bolt Only
<b>M24</b> <b>3.0 mm Pitch</b>	50	5	B88MZ240501	B88MZ240502
	55		B88MZ240551	B88MZ240552
	60		B88MZ240601	B88MZ240602
	65		B88MZ240651	B88MZ240652
	70		B88MZ240701	B88MZ240702
	75		B88MZ240751	B88MZ240752
	80		B88MZ240801	B88MZ240802
	90		B88MZ240901	B88MZ240902
	100		B88MZ241001	B88MZ241002
	110		B88MZ241101	B88MZ241102
	120		B88MZ241201	B88MZ241202
	130		B88MZ241301	B88MZ241302
	140		B88MZ241401	B88MZ241402
	150		B88MZ241501	B88MZ241502
	160		B88MZ241601	B88MZ241602
	170		B88MZ241701	B88MZ241702
	180		B88MZ241801	B88MZ241802
	190		B88MZ241901	B88MZ241902
	200		B88MZ242001	B88MZ242002
	210		B88MZ242101	B88MZ242102
220		B88MZ242201	B88MZ242202	
230		B88MZ242301	B88MZ242302	
240		B88MZ242401	B88MZ242402	
250		B88MZ242501	B88MZ242502	

**HIGH TENSILE - METRIC**

**BREMICK™**



## HEXAGON HEAD BOLTS & NUTS

Class 8.8 AS 1110 - 2000 / AS 1112 - 2000  
BLACK

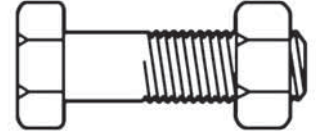

Diameter (mm)	Length (mm)	Std. Pack	Product Code Bolt & Nut	Product Code Bolt Only
M30 3.5 mm Pitch	70	5	B88MP300701	B88MP300702
	75		B88MP300751	B88MP300752
	80		B88MP300801	B88MP300802
	85		B88MP300851	B88MP300852
	90		B88MP300901	B88MP300902
	100		B88MP301001	B88MP301002
	110		B88MP301101	B88MP301102
	120		B88MP301201	B88MP301202
	130		B88MP301301	B88MP301302
	140		B88MP301401	B88MP301402
	150		B88MP301501	B88MP301502
	160		B88MP301601	B88MP301602
	170		B88MP301701	B88MP301702
	180		B88MP301801	B88MP301802
	190		B88MP301901	B88MP301902
	200		B88MP302001	B88MP302002
	210		B88MP302101	B88MP302102
	220		B88MP302201	B88MP302202
	230		B88MP302301	B88MP302302
	240		B88MP302401	B88MP302402
250		B88MP302501	B88MP302502	

HIGH TENSILE - METRIC

BREMICK™

# HEXAGON HEAD SET SCREWS



**Class 8.8 AS 1110 - 2000**  
**ZINC PLATED**

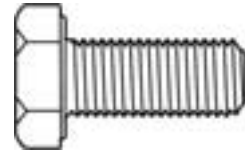

Diameter (mm)	Length (mm)	Product Code	Std. Pack
<b>M6</b> <b>1.0 mm Pitch</b>	12	S88MZ060122	200
	16	S88MZ060162	
	20	S88MZ060202	
	25	S88MZ060252	
	30	S88MZ060302	
	35	S88MZ060352	
	40	S88MZ060402	
	45	S88MZ060452	
	50	S88MZ060502	
<b>M8</b> <b>1.25 mm Pitch</b>	12	S88MZ080122	200
	16	S88MZ080162	
	20	S88MZ080202	
	25	S88MZ080252	
	30	S88MZ080302	
	35	S88MZ080352	
	40	S88MZ080402	
	45	S88MZ080452	150
	50	S88MZ080502	
	55	S88MZ080552	
	60	S88MZ080602	
	65	S88MZ080652	
	70	S88MZ080702	100
	75	S88MZ080752	
	100	S88MZ081002	
<b>M10</b> <b>1.5 mm Pitch</b>	12	S88MZ100122	150
	16	S88MZ100162	
	20	S88MZ100202	
	25	S88MZ100252	
	30	S88MZ100302	
	35	S88MZ100352	
	40	S88MZ100402	
	45	S88MZ100452	
	50	S88MZ100502	

CONTINUED OVER PAGE ►

**HIGH TENSILE - METRIC**

**BREMICK™**



## HEXAGON HEAD BOLTS & NUTS

Class 8.8 AS 1110 - 2000  
ZINC PLATED (CONTINUED)

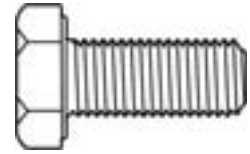

Diameter (mm)	Length (mm)	Product Code	Std. Pack
M12 1.75 mm Pitch	20	S88MZ120202	100
	25	S88MZ120252	
	30	S88MZ120302	
	35	S88MZ120352	
	40	S88MZ120402	
	45	S88MZ120452	75
	50	S88MZ120502	
	55	S88MZ120552	50
	60	S88MZ120602	
	65	S88MZ120652	25
	70	S88MZ120702	
	75	S88MZ120752	
M16 2.0 mm Pitch	30	S88MZ160302	25
	35	S88MZ160352	
	40	S88MZ160402	
	45	S88MZ160452	
	50	S88MZ160502	
	55	S88MZ160552	
	60	S88MZ160602	
	65	S88MZ160652	
	70	S88MZ160702	
	75	S88MZ160752	

HIGH TENSILE - METRIC

BREMICK™

## THREADED ROD 3 FOOT



### BSW IFI 136 PLAIN FINISH

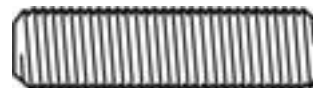

Diameter (inches)	Product Code	Std. Pack
3/16	RTRWP050032	20
1/4	RTRWP060032	
5/16	RTRWP080032	
3/8	RTRWP100032	
7/16	RTRWP110032	10
1/2	RTRWP120032	
5/8	RTRWP160032	
3/4	RTRWP200032	
7/8	RTRWP220032	5
1	RTRWP240032	
1.1/8	RTRWP270032	1
1.1/4	RTRWP300032	
1.1/2	RTRWP360032	

*per 3 ft length*

### BSW IFI 136 ZINC PLATED

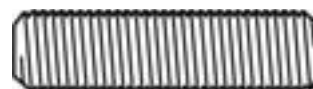

Diameter (inches)	Product Code	Std. Pack
3/16	RTRWZ050032	20
1/4	RTRWZ060032	
5/16	RTRWZ080032	
3/8	RTRWZ100032	
7/16	RTRWZ110032	10
1/2	RTRWZ120032	
5/8	RTRWZ160032	
3/4	RTRWZ200032	
7/8	RTRWZ220032	5
1	RTRWZ240032	
1.1/8	RTRWZ270032	1
1.1/4	RTRWZ300032	
1.1/2	RTRWZ360032	

*per 12 ft length*

THREADED ROD - BSW

**BREMICK**<sup>TM</sup>



## THREADED ROD 12 FOOT

**BSW IFI 136  
PLAIN FINISH**

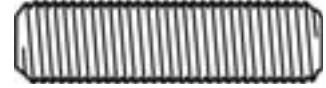

Diameter (inches)	Product Code	Std. Pack
3/16	RTRWP050122	20
1/4	RTRWP060122	
5/16	RTRWP080122	
3/8	RTRWP100122	
1/2	RTRWP120122	10
5/8	RTRWP160122	
3/4	RTRWP200122	
7/8	RTRWP220122	5
1	RTRWP240122	
1.1/8	RTRWP270122	1
1.1/4	RTRWP300122	
1.1/2	RTRWP360122	

*per 12 ft length*

**BSW IFI 136  
ZINC PLATED**

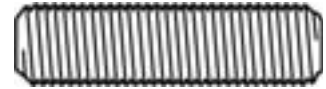

Diameter (inches)	Product Code	Std. Pack
3/16	RTRWZ050122	20
1/4	RTRWZ060122	
5/16	RTRWZ080122	
3/8	RTRWZ100122	
1/2	RTRWZ120122	10
5/8	RTRWZ160122	
3/4	RTRWZ200122	
7/8	RTRWZ220122	5
1	RTRWZ240122	
1.1/8	RTRWZ270122	1
1.1/4	RTRWZ300122	
1.1/2	RTRWZ360122	

*per 12 ft length*

## THREADED ROD 3 FOOT



### UNC IFI 136 PLAIN FINISH

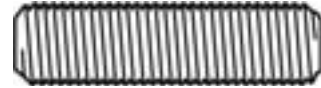

Diameter (inches)	Product Code	Std. Pack
3/16	RTRCP050032	20
1/4	RTRCP060032	
5/16	RTRCP080032	
3/8	RTRCP100032	
7/16	RTRCP110032	10
1/2	RTRCP120032	
5/8	RTRCP160032	
3/4	RTRCP200032	
7/8	RTRCP220032	5
1	RTRCP240032	
1.1/8	RTRCP270032	1
1.1/4	RTRCP300032	
1.1/2	RTRCP360032	

*per 3 ft length*

### UNF IFI 136 PLAIN FINISH

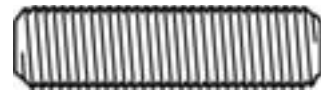

Diameter (inches)	Product Code	Std. Pack
3/16	RTRFP050032	20
1/4	RTRFP060032	
5/16	RTRFP080032	
3/8	RTRFP100032	
7/16	RTRFP110032	10
1/2	RTRFP120032	
5/8	RTRFP160032	
3/4	RTRFP200032	
7/8	RTRFP220032	5
1	RTRFP240032	
1.1/8	RTRFP270032	1
1.1/4	RTRFP300032	
1.1/2	RTRFP360032	

*per 3 ft length*



## THREADED ROD 1 METRE

### Metric 4.6 DIN 975 PLAIN FINISH

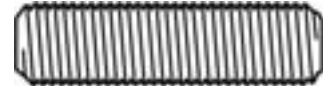

Diameter (mm)	Product Code	Std. Pack
M3	RTRMP031002	20
M4	RTRMP041002	
M5	RTRMP051002	
M6	RTRMP061002	
M8	RTRMP081002	
M10	RTRMP101002	
M12	RTRMP121002	10
M16	RTRMP161002	
M20	RTRMP201002	5
M24	RTRMP241002	
M30	RTRMP301002	1
M36	RTRMP361002	
M42	RTRMP421002	
M48	RTRMP481002	
M56	RTRMP561002	
M64	RTRMP641002	

*per 1 m length*

### Metric 4.6 DIN 975 GALVANISED

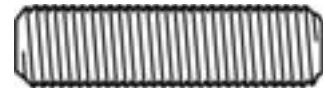

Diameter (mm)	Product Code	Std. Pack
M10	RTRMG101002	20
M12	RTRMG121002	10
M16	RTRMG161002	
M20	RTRMG201002	5
M24	RTRMG241002	
M30	RTRMG301002	1
M36	RTRMG361002	
M42	RTRMG421002	
M48	RTRMG481002	
M56	RTRMG561002	
M64	RTRMG641002	

*per 1 m length*



## THREADED ROD 1 METRE

**Metric 4.6 DIN 975  
ZINC PLATED**

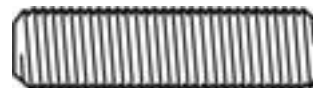

Diameter (mm)	Product Code	Std. Pack
M3	RTRMZ031002	20
M4	RTRMZ041002	
M5	RTRMZ051002	
M6	RTRMZ061002	
M8	RTRMZ081002	
M10	RTRMZ101002	
M12	RTRMZ121002	10
M16	RTRMZ161002	
M20	RTRMZ201002	5
M24	RTRMZ241002	
M30	RTRMZ301002	1
M36	RTRMZ361002	
M42	RTRMZ421002	
M48	RTRMZ481002	

*per 1 m length*

## THREADED ROD 3 METRE

**Metric 4.6 DIN 975  
PLAIN FINISH**

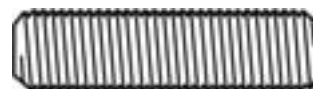

Diameter (mm)	Product Code	Std. Pack
M6	RTRMP063002	20
M8	RTRMP083002	
M10	RTRMP103002	
M12	RTRMP123002	10
M16	RTRMP163002	
M20	RTRMP203002	5
M24	RTRMP243002	
M30	RTRMP303002	1
M36	RTRMP363002	

*per 3 m length*



THREADED ROD - METRIC

**BREMICK**<sup>TM</sup>



## THREADED ROD 3 METRE

**Metric 4.6 DIN 975  
GALVANISED**

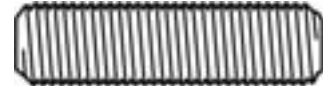

Diameter (mm)	Product Code	Std. Pack
M10	RTRMG103002	20
M12	RTRMG123002	10
M16	RTRMG163002	
M20	RTRMG203002	5
M24	RTRMG243002	
M30	RTRMG303002	1
M36	RTRMG363002	

*per 3 m length*

**Metric 4.6 DIN 975  
ZINC PLATED**

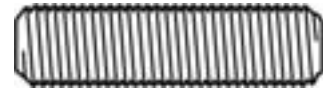

Diameter (mm)	Product Code	Std. Pack
M6	RTRMZ063002	20
M8	RTRMZ083002	
M10	RTRMZ103002	
M12	RTRMZ123002	10
M16	RTRMZ163002	
M20	RTRMZ203002	5
M24	RTRMZ243002	
M30	RTRMZ303002	1
M36	RTRMZ363002	

*per 3 m length*

## THREADED ROD 1 METRE



**Class 8.8 DIN 975  
BLACK**

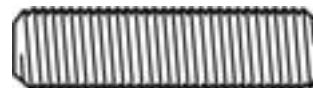

Diameter (mm)	Product Code	Std. Pack
M6	R88MP061002	20
M8	R88MP081002	
M10	R88MP101002	
M12	R88MP121002	10
M16	R88MP161002	
M20	R88MP201002	5
M24	R88MP241002	
M30	R88MP301002	1
M36	R88MP361002	
M42	R88MP421002	
M48	R88MP481002	

*per 1 m length*

**Class 8.8 DIN 975  
GALVANISED**

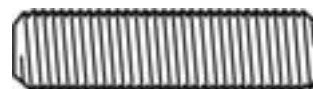

Diameter (mm)	Product Code	Std. Pack
M10	R88MG101002	20
M12	R88MG121002	10
M16	R88MG161002	
M20	R88MG201002	5
M24	R88MG241002	
M30	R88MG301002	1
M36	R88MG361002	

*per 1 m length*

THREADED ROD - CLASS 8.8

**BREMICK**<sup>TM</sup>



# HEX COUPLING NUTS

**METRIC  
GALVANISED**

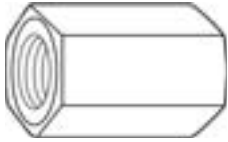

Diameter (mm)	Length (mm)	Product Code	Std. Pack
M10	40	NHCMG100402	100
M12	40	NHCMG120402	
M16	50	NHCMG160502	50
M20	50	NHCMG200502	25
M24	50	NHCMG240502	20
M30	60	NHCMG300602	5
M36	70	NHCMG360702	

**METRIC  
YELLOW ZINC PLATED**



Diameter (mm)	Length (mm)	Product Code	Std. Pack
M6	25	NHCMZ060252	100
M8	25	NHCMZ080252	
M10	40	NHCMZ100402	
M12	40	NHCMZ120402	
M16	50	NHCMZ160502	50
M20	50	NHCMZ200502	25
M24	50	NHCMZ240502	20
M30	60	NHCMZ300602	5
M36	70	NHCMZ360702	

## SQUARE WASHERS



### METRIC GALVANISED

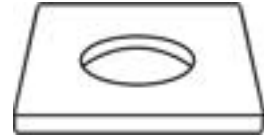

Size (mm)	I.D. (mm)	Side Length (mm)	Thickness (mm)	Product Code	Std. Pack
M12	13	50	3	WSQMG125032	200
M16	17	50	5	WSQMG165052	
M16	17	65	5	WSQMG166552	100
M20	21	65	5	WSQMG206552	
M20	21	75	6	WSQMG207562	50
M24	25	75	6	WSQMG247562	

### METRIC ZINC PLATED



Size (mm)	I.D. (mm)	Side Length (mm)	Thickness (mm)	Product Code	Std. Pack
M12	13	50	3	WSQMZ125032	200
M16	17	50	5	WSQMZ165052	
M16	17	65	5	WSQMZ166552	100
M20	21	65	5	WSQMZ206552	



## HEXAGON NUTS

### GRADE 5 UNC AS2465 -1999 BLACK PACKETS



Diameter (inches)	Product Code	Std. Pack
1/4	N50CP0600P2	1000
5/16	N50CP0800P2	
3/8	N50CP1000P2	500
7/16	N50CP1100P2	

### GRADE 5 UNC AS2465 -1999 ZINC PLATED PACKETS



Diameter (inches)	Product Code	Std. Pack
1/4	N50CZ0600P2	1000
5/16	N50CZ0800P2	
3/8	N50CZ1000P2	500
7/16	N50CZ1100P2	

### GRADE 5 UNC AS2465 -1999 BLACK BULK



Diameter (inches)	Product Code	Std. Pack
1/4	N50CP0600N2	5000
5/16	N50CP0800N2	3000
3/8	N50CP1000N2	2000
7/16	N50CP1100N2	1300

### GRADE 5 UNC AS2465 -1999 ZINC PLATED BULK



Diameter (inches)	Product Code	Std. Pack
1/4	N50CZ0600N2	5000
5/16	N50CZ0800N2	3000
3/8	N50CZ1000N2	2000
7/16	N50CZ1100N2	1300

## HEXAGON NUTS



### GRADE 8 UNC AS2465 -1999 BLACK

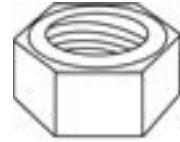

Diameter (inches)	Product Code	Std. Pack
1/2	N80CP1200P2	200
9/16	N80CP1400P2	75
5/8	N80CP1600P2	
3/4	N80CP2000P2	
7/8	N80CP2200P2	50
1	N80CP2400P2	
1.1/8	N80CP2700P2	25
1.1/4	N80CP3000P2	
1.1/2	N80CP3600P2	15

### GRADE 8 UNC AS2465 -1999 ZINC PLATED



Diameter (inches)	Product Code	Std. Pack
1/2	N80CZ1200P2	200
9/16	N80CZ1400P2	75
5/8	N80CZ1600P2	
3/4	N80CZ2000P2	
7/8	N80CZ2200P2	50
1	N80CZ2400P2	



## HEXAGON NUTS

### GRADE 5 UNF AS2465 -1999 BLACK PACKETS



Diameter (inches)	Product Code	Std. Pack
1/4	N50FP0600P2	1000
5/16	N50FP0800P2	
3/8	N50FP1000P2	500
7/16	N50FP1100P2	

### GRADE 5 UNF AS2465 -1999 ZINC PLATED PACKETS



Diameter (inches)	Product Code	Std. Pack
1/4	N50FZ0600P2	1000
5/16	N50FZ0800P2	
3/8	N50FZ1000P2	500
7/16	N50FZ1100P2	

### GRADE 5 UNF AS2465 -1999 BLACK BULK



Diameter (inches)	Product Code	Std. Pack
1/4	N50FP0600N2	5000
5/16	N50FP0800N2	3000
3/8	N50FP1000N2	2000
7/16	N50FP1100N2	1300

### GRADE 5 UNF AS2465 -1999 ZINC PLATED BULK



Diameter (inches)	Product Code	Std. Pack
1/4	N50FZ0600N2	5000
5/16	N50FZ0800N2	3000
3/8	N50FZ1000N2	2000
7/16	N50FZ1100N2	1300



## HEXAGON NUTS



### GRADE 8 UNF AS2465 -1999 BLACK



Diameter (inches)	Product Code	Std. Pack
1/2	N80FP1200P2	200
9/16	N80FP1400P2	75
5/8	N80FP1600P2	
3/4	N80FP2000P2	
7/8	N80FP2200P2	50
1	N80FP2414P2	

### GRADE 8 UNF AS2465 -1999 ZINC PLATED



Diameter (inches)	Product Code	Std. Pack
1/2	N80FZ1200P2	200
9/16	N80FZ1400P2	75
5/8	N80FZ1600P2	
3/4	N80FZ2000P2	
7/8	N80FZ2200P2	50
1	N80FZ2400P2	



## HEXAGON NUTS

### BSW AS 2451 - 1998 PLAIN FINISH



Diameter (inches)	Product Code	Std. Pack
1/4	N20WP0600N2	6000
5/16	N20WP0800N2	4000
3/8	N20WP1000N2	3000
1/2	N20WP1200N2	1000
5/8	N20WP1600N2	500
3/4	N20WP2000N2	250
7/8	N20WP2200N2	200
1	N20WP2400N2	150

### BSW AS 2451 - 1998 ZINC PLATED



Diameter (inches)	Product Code	Std. Pack
1/4	N20WZ0600N2	6000
5/16	N20WZ0800N2	4000
3/8	N20WZ1000N2	3000
1/2	N20WZ1200N2	1000
5/8	N20WZ1600N2	500
3/4	N20WZ2000N2	250
7/8	N20WZ2200N2	200
1	N20WZ2400N2	150

## HEXAGON NUTS



### CLASS 8 METRIC AS 1112 - 2000 PLAIN PACKETS



Diameter (mm)	Product Code	Std. Pack
* M5	N46MP0500P2	1000
M6	N46MP0600P2	
M8	N46MP0800P2	
M10	N46MP1000P2	500
M12	N46MP1200P2	
M16	N46MP1600P2	200
• M20	N46MP2000P2	100
• M24	N46MP2400P2	50

\* Class 5 • Style 2 see page 121

### CLASS 8 METRIC AS 1112 - 2000 GALVANISED PACKETS



Diameter (mm)	Product Code	Std. Pack
M6	N46MG0600P2	1000
M8	N46MG0800P2	
M10	N46MG1000P2	500
M12	N46MG1200P2	
M16	N46MG1600P2	200
• M20	N46MG2000P2	100
• M24	N46MG2400P2	50

• Style 2 see page 121

### CLASS 8 METRIC AS 1112 - 2000 ZINC PLATED PACKETS



Diameter (mm)	Product Code	Std. Pack
* M3	N46MZ0300P2	1000
* M4	N46MZ0400P2	
* M5	N46MZ0500P2	
M6	N46MZ0600P2	
M8	N46MZ0800P2	
M10	N46MZ1000P2	500
M12	N46MZ1200P2	
M16	N46MZ1600P2	200
• M20	N46MZ2000P2	100
• M24	N46MZ2400P2	50

\* Class 5 • Style 2 see page 121



## HEXAGON NUTS

### CLASS 8 METRIC AS 1112 - 2000 PLAIN BULK



Diameter (mm)	Product Code	Std. Pack
* M5	N46MP0500N2	10000
M6	N46MP0600N2	5000
M8	N46MP0800N2	3000
M10	N46MP1000N2	2000
M12	N46MP1200N2	800
M16	N46MP1600N2	400
• M20	N46MP2000N2	250
• M24	N46MP2400N2	150
• M30	N88MP3000N2	75

\* Class 5 • Style 2 see page 121

### CLASS 8 METRIC AS 1112 - 2000 GALVANISED BULK



Diameter (mm)	Product Code	Std. Pack
M6	N46MG0600N2	5000
M8	N46MG0800N2	3000
M10	N46MG1000N2	2000
M12	N46MG1200N2	800
M16	N46MG1600N2	400
• M20	N46MG2000N2	250
• M24	N46MG2400N2	150

• Style 2 see page 121

### CLASS 8 METRIC AS 1112 - 2000 ZINC PLATED BULK



Diameter (mm)	Product Code	Std. Pack
* M3	N46MZ0300N2	10000
* M4	N46MZ0400N2	
* M5	N46MZ0500N2	
M6	N46MZ0600N2	5000
M8	N46MZ0800N2	3000
M10	N46MZ1000N2	2000
M12	N46MZ1200N2	800
M16	N46MZ1600N2	400
• M20	N46MZ2000N2	250
• M24	N46MZ2400N2	150

\* Class 5 • Style 2 see page 121

## HEXAGON NUTS



### CLASS 5 METRIC AS 1112 - 2000 GALVANISED BULK



Diameter (mm)	Product Code	Std. Pack
M30	N46MP3000N2	100
M33	N46MP3300N2	50
M36	N46MP3600N2	
M42	N46MP4200N2	25
M48	N46MP4800N2	
M56	N46MP5600N2	15
M64	N46MP6400N2	5

### CLASS 5 METRIC AS 1112 - 2000 PLAIN BULK



Diameter (mm)	Product Code	Std. Pack
M30	N46MG3000N2	100
M33	N46MG3300N2	50
M36	N46MG3600N2	
M42	N46MG4200N2	25
M48	N46MG4800N2	
M56	N46MG5600N2	15
M64	N46MG6400N2	5



## HEXAGON NYLON INSERT LOCKNUTS

### UNC NM - NE Series ZINC PLATED

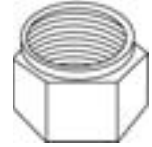

Diameter (inches)	Product Code	Std. Pack
3/16 (10g)	NNYCZ0500P2	500
1/4	NNYCZ0600P2	
5/16	NNYCZ0800P2	400
3/8	NNYCZ1000P2	
7/16	NNYCZ1100P2	200
1/2	NNYCZ1200P2	
9/16	NNYCZ1400P2	100
5/8	NNYCZ1600P2	
3/4	NNYCZ2000P2	50
7/8	NNYCZ2200P2	
1	NNYCZ2400P2	25
1.1/8	NNYCZ2700P2	
1.1/4	NNYCZ3000P2	10
1.1/2	NNYCZ3600P2	
1.3/4	NNYCZ4200P2	4
2	NNYCZ4800P2	

### UNF NM - NE Series ZINC PLATED



Diameter (inches)	Product Code	Std. Pack
3/16 (10g)	NNYFZ0500P2	500
1/4	NNYFZ0600P2	
5/16	NNYFZ0800P2	400
3/8	NNYFZ1000P2	
7/16	NNYFZ1100P2	200
1/2	NNYFZ1200P2	
9/16	NNYFZ1400P2	100
5/8	NNYFZ1600P2	
3/4	NNYFZ2000P2	50
7/8	NNYFZ2200P2	
1-12	NNYFZ2412T2	25
1-14	NNYFZ2414T2	
1.1/8	NNYFZ2700P2	
1.1/4	NNYFZ3000P2	10
1.1/2	NNYFZ3600P2	

## HEXAGON NYLON INSERT LOCKNUTS



**BSW DIN 985  
ZINC PLATED**



Diameter (inches)	Product Code	Std. Pack
3/16	NNYWZ0500P2	200
1/4	NNYWZ0600P2	
5/16	NNYWZ0800P2	
3/8	NNYWZ1000P2	
7/16	NNYWZ1100P2	
1/2	NNYWZ1200P2	
9/16	NNYWZ1400P2	
5/8	NNYWZ1600P2	100
3/4	NNYWZ2000P2	50
7/8	NNYWZ2200P2	
1	NNYWZ2400P2	25

**Metric Coarse DIN 985  
ZINC PLATED**



Diameter (inches)	Product Code	Std. Pack
M3	NNYMZ0300P2	500
M4	NNYMZ0400P2	
M5	NNYMZ0500P2	
M6	NNYMZ0600P2	
M8	NNYMZ0800P2	400
M10	NNYMZ1000P2	
M12	NNYMZ1200P2	200
M16	NNYMZ1600P2	100
M20	NNYMZ2000P2	50
M24	NNYMZ2400P2	25
M30	NNYMZ3000P2	10
M36	NNYMZ3600P2	
M42	NNYMZ4200P2	
M48	NNYMZ4800P2	4

NYLON INSERT LOCKNUTS

**BREMICK**<sup>TM</sup>



## FLAT ROUND WASHERS

### IMPERIAL PLAIN FINISH

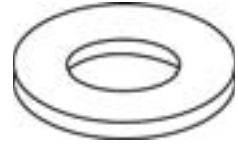

Nominal Bolt Size (Inches)	Product Code	Std Pack	Inner Bags
7/16	WFRIP1100P2	2500	10 X 250
7/8	WFRIP2200P2	500	10 X 50
1.1/8	WFRIP2700P2	200	8 X 25
1.1/4	WFRIP3000P2		8 X 25
1.1/2	WFRIP3600P2	100	10 X 10
1.3/4	WFRIP4200P2	70	7 X 10
2	WFRIP4800P2	50	5 X 10

### METRIC PLAIN FINISH

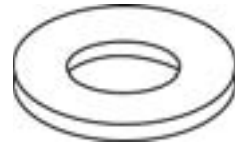

Nominal Bolt Size (mm)	Diameter (mm)	Equivalent Size (Inches)	Product Code	Std Pack	Inner Bags
M6	6	1/4	WFRMP0600P2	7500	15 X 500
M8	8	5/16	WFRMP0800P2	5000	10 X 500
M10	10	3/8	WFRMP1000P2	2500	5 X 500
M12	12	1/2	WFRMP1200P2	2000	10 X 200
M16	16	5/8	WFRMP1600P2	1000	5 X 200
M20	20	3/4	WFRMP2000P2	750	5 X 150
M24	24	1	WFRMP2400P2	250	10 X 25
M30	30		WFRMP3000P2		10 X 25
M36	36	1.3/8	WFRMP3600P2	125	5 X 25
M42	42		WFRMP4200P2	100	10 X 10
M48	48	2	WFRMP4800P2	70	7 X 10
M56	56	2.1/4	WFRMP5600P2	30	3 X 10
M64	64	2.1/2	WFRMP6400P2		3 X 10



## FLAT ROUND WASHERS



### IMPERIAL GALVANISED

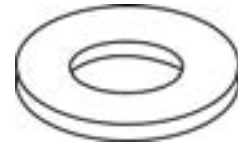

Nominal Bolt Size (Inches)	Product Code	Std Pack	Inner Bags
7/8	WFRIG2200P2	500	10 X 50
1.1/8	WFRIG2700P2	200	8 X 25
1.1/4	WFRIG3000P2		8 X 25
1.1/2	WFRIG3600P2	100	10 X 10
1.3/4	WFRIG4200P2	70	7 X 10

### METRIC GALVANISED

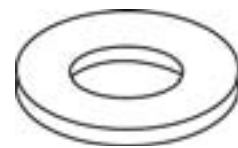

Nominal Bolt Size (mm)	Diameter (mm)	Equivalent Size (Inches)	Product Code	Std Pack	Inner Bags
M6	6	1/4	WFRMG0600P2	7500	15 X 500
M8	8	5/16	WFRMG0800P2	5000	10 X 500
M10	10	3/8	WFRMG1000P2	2500	5 X 500
M12	12	1/2	WFRMG1200P2	2000	10 X 200
M16	16	5/8	WFRMG1600P2	1000	5 X 200
M20	20	3/4	WFRMG2000P2	750	5 X 150
M24	24	1	WFRMG2400P2	250	10 X 25
M30	30		WFRMG3000P2		10 X 25
M36	36	1.3/8	WFRMG3600P2	125	5 X 25
M42	42		WFRMG4200P2	100	10 X 10
M48	48		WFRMG4800P2	70	7 X 10
M56	56	2.1/4	WFRMG5600P2	30	3 X 10
M64	64	2.1/2	WFRMG6400P2		3 X 10

WASHERS

BREMICK™



## FLAT ROUND WASHERS

**METRIC  
ZINC PLATED**

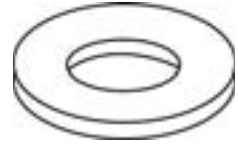

Nominal Bolt Size (mm)	Diameter (mm)	Equivalent Size (Inches)	Product Code	Std Pack	Inner Bags
M6	6	1/4	WFRMZ0600P2	7500	15 X 500
M8	8	5/16	WFRMZ0800P2	5000	10 X 500
M10	10	3/8	WFRMZ1000P2	2500	5 X 500
M12	12	1/2	WFRMZ1200P2	2000	10 X 200
M16	16	5/8	WFRMZ1600P2	1000	5 X 200
M20	20	3/4	WFRMZ2000P2	750	5 X 150
M24	24	1	WFRMZ2400P2	250	10 X 25
M30	30	1.1/4	WFRMZ3000P2		10 X 25

**GRADE 8 ASTM - F436  
ZINC PLATED**

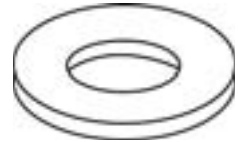

Nominal Size (inches)	Nominal Outside Diameter	Nominal Inside Diameter	Thickness Min. (inches)	Thickness Max. (inches)	Product Code	Std Pack
1-4	5/8	10471	0.051	0.08	W80IY0600P2	100
5/16	11/16	11/32	0.051	0.08	W80IY0800P2	
3/8	13/16	13/32	0.051	0.08	W80IY1000P2	
7/16	59/64	15/32	0.051	0.08	W80IY1100P2	
1/2	1.1/6	17/32	0.097	0.177	W80IY1200P2	
9/16	1.3/16	19/32	0.097	0.177	W80IY1400P2	
5/8	1.5/16	41213	0.122	0.177	W80IY1600P2	50
3/4	1.15/32	13/16	0.122	0.177	W80IY2000P2	
7/8	1.3/4	15/16	0.136	0.177	W80IY2200P2	
1	2	1.1/8	0.136	0.177	W80IY2400P2	
1.1/8	2.1/4	1.1/4	0.136	0.177	W80IY2700P2	20
1.1/4	2.1/2	1.3/8	0.136	0.177	W80IY3000P2	10
1.3/8	2.3/4	1.1/2	0.136	0.177	W80IY3300P2	
1.1/2	3	1.5/8	0.136	0.177	W80IY3600P2	

WASHERS

BREMICK™

# THREAD CHART



Nom Size	Threads per Inch & Tapping Drill Size		UNC	Tapping Drill	UNF	Tapping Drill	Nom Size	Tapping Drill	ISO Metric Pitch	
	BSW	Tapping Drill							Coarse	Fin e
3/16*	24	3.7mm	24	3.9mm	32	4.1mm	M5	4.2mm	0.80	0.50
1/4	20	5.1mm	20	13/64	28	7/32	M6	5.1mm	1.00	0.75
5/16	18	6.5mm	18	6.6mm	24	7.0mm	M8	6.8mm	1.25	1.00
3/8	16	5/16	16	8.0mm	24	8.5mm	M10	8.6mm	1.50	1.25
7/16	14	9.3mm	14	9.4mm	20	25/64	M12	10.4mm	1.75	1.25
1/2	12	27/64	13	10.9mm	20	29/64	M14	12.1mm	2.00	1.50
9/16	12	31/64	12	31/64	18	13.0mm	M16	14.0mm	2.00	1.50
5/8	11	17/32	11	35/64	18	14.5mm	M18	15.5mm	2.50	1.50
3/4	10	16.5mm	10	21/32	16	17.5mm	M20	17.5mm	2.50	1.50
7/8	9	49/64	9	49/64	14	20.5mm	M22	19.5mm	2.50	1.50
1	8	7/8	8	57/64	12	59/64	M24	21.0mm	3.00	2.00
1.1/8	7	63/64	7	63/64	12	1.3/64	M27	24.0mm	3.00	-
1.1/4	7	1.7/64	7	1.7/64	12	1.11/64	M30	26.5mm	3.50	-
1.3/8	6	1.13/64	6	1.7/32	12	33.0mm	M36	32.0mm	4.00	-
1.1/2	6	1.21/64	6	1.11/32	12	1.27/64	M39		4.00	-
1.3/4	5	1.35/64	5	1.39/64	12		M42		4.50	-
2	4.5	45mm	4.5	1.55/64			M48		5.00	-

\* 10g for UNC/UNF



## BOLT STANDARDS

UNIFIED HIGH TENSILE HEXAGON BOLTS, SCREWS AND HEXAGON NUTS,  
INCH SERIES, UNC AND UNF THREADS  
TO AUSTRALIAN STANDARD 2465 - 1999 GRADE 5 - GRADE 8  
(EQUIVALENT TO DIMENSIONS OF ANSI B18.2.1)

Nom Diameter	Threads per inch		Shank Diameter		Head Thickness		Across Flats		Nut Thickness	
	UNC	UNF	Max.	Min.	Max.	Min.	Max.	Min.	Max.	Min.
1/4	20	28	0.250	0.245	0.163	0.150	0.438	0.428	0.226	0.212
5/16	18	24	0.3125	0.3065	0.211	0.195	0.500	0.489	0.273	0.258
3/8	16	24	0.375	0.369	0.243	0.226	0.562	0.551	0.337	0.320
7/16	14	20	0.4375	0.4305	0.291	0.272	0.625	0.612	0.385	0.365
1/2	13	20	0.500	0.493	0.323	0.302	0.750	0.736	0.448	0.427
5/8	11	18	0.625	0.617	0.403	0.378	0.938	0.922	0.559	0.535
3/4	10	16	0.750	0.741	0.483	0.455	1.125	1.100	0.665	0.617
7/8	9	14	0.875	0.866	0.563	0.531	1.312	1.285	0.776	0.724
1	8	14	1.000	0.990	0.627	0.591	1.500	1.469	0.887	0.831

METRIC HIGH TENSILE, PRECISION HEXAGON HEAD BOLTS, SCREWS AND  
HEXAGON NUTS.

ISO METRIC COARSE PITCH SERIES THREADS, CLASS 6g.

PROPERTY CLASS 8.8

TO AUSTRALIAN STANDARDS, BOLTS AND SCREWS AS 1110-2000

NUTS AS1112-2000

Nom Diameter	Pitch of Threads		Shank Diameter		Width Across Flats		Head Thickness		Nut Thickness	
	Coarse	Fine	Max.	Min.	Max.	Min.	Max.	Min.	Max.	Min.
M6	1.00	0.75	6.00	5.82	10.00	9.78	4.15	3.85	5.20	4.90
M8	1.25	1.00	8.00	7.78	13.00	12.73	5.45	5.15	6.80	6.44
M10	1.50	1.25	10.00	9.78	16.00	15.73	6.58	6.22	8.40	8.04
M12	1.75	1.25	12.00	11.73	18.00	17.73	7.68	7.32	10.80	10.37
M14	2.00	1.50	14.00	13.73	21.00	20.67	8.98	8.62	12.80	12.10
M16	2.00	1.50	16.00	15.73	24.00	23.67	10.18	9.82	14.80	14.01
M20	2.50	1.50	20.00	19.67	30.00	29.67	12.715	12.285	18.00*	16.90*
M24	3.00	2.00	24.00	23.67	36.00	35.38	15.215	14.785	21.50*	20.20*

\*Style 2 see page 121

Style 2 Nut Thicknesses from AS1112.2-2000

Diameter	Nut Thickness	
	Max.	Min.
M20	20.30	19.00
M24	23.90	22.60

# FASTENER GRADES & MARKINGS



Product Group	BSW Hex Bolt and Nut	Metric Hex Bolt and Nut	BSW Cup Head Bolt and Nut	Metric Cup Head Bolt and Nut	Metric Coach Screw	
Mild Steel Commercial	Grade 2	Class 4.6	Grade 2	Class 4.6	Class 4.6	
Product Specification	AS2451-1998	AS1111-2000 (Bolt) AS1112-2000 (Nut)	ASB108-1952 (Bolt) AS2451-1998 (Nut)	AS1390-1997 (Bolt) AS1112-2000 (Nut)	AS1393-1996	
Nominal Strengths						
	Tensile	63,000 lb/in <sup>2</sup>	400MPa	58,000 lb/in <sup>2</sup>	400MPa	400MPa
Bolt	Yield	36,000 lb/in <sup>2</sup>	240MPa		240MPa	240MPa
	Proof		225MPa		225MPa	225MPa
Nut	Proof	63,000 lb/in <sup>2</sup>	520-630MPa*	63,000 lb/in <sup>2</sup>	520-630MPa*	
Grade Marking						

\*See Nut Property Class Table Below

Product Group	UNC/UNF High Tensile Bolt and Nut	UNC/UNF High Tensile Bolt and Nut	Metric High Tensile Bolt and Nut	Metric Structural Bolt and Nut	
	Grade 5	Grade 8	Class 8.8	Class 8.8	
Product Specification	AS2465-1999	AS2465-1999	AS1110-2000 (Bolt) AS1112-2000 (Nut)	AS1252-1983	
Nominal Strengths					
Bolt	Tensile	105,000-120,000 lb/in <sup>2</sup>	150,000 lb/in <sup>2</sup>	800MPa	800MPa
	Yield	81,000-92,000 lb/in <sup>2</sup>	130,000 lb/in <sup>2</sup>	640MPa	640MPa
	Proof	74,000-85,000 lb/in <sup>2</sup>	120,000 lb/in <sup>2</sup>	580MPa	600MPa
Nut	Proof	UNC 120,000 lb/in <sup>2</sup> UNF 109,000 lb/in <sup>2</sup>	150,000 lb/in <sup>2</sup>	800-920MPa*	1165MPa
Grade Marking					

\*See Nut Property Class Table Below

Thread		Nut Property Class		
Greater Than	Less Than or Equal To	5 Style 1 Stress Under Proof Load	8 Style 1 Stress Under Proof Load	8 Style 2 Stress Under Proof Load
-	M4	520 MPa	800 MPa	-
M4	M7	580 MPa	855 MPa	-
M7	M10	590 MPa	870 MPa	-
M10	M16	610 MPa	880 MPa	-
M16	M39	630 MPa	920 MPa	890 MPa



## WASHER STANDARD

NEAREST EQUIVALENT STANDARDS: BS3410-1961 AND AS1237 -2002  
 NORMAL SERIES, SUITABLE FOR USE WITH METRIC AND IMPERIAL  
 COMMERCIAL GRADE BOLTS, FOR EXAMPLE BOLTS SELECTED FROM AS1111,  
 AS2451 OR ASB148.

BY AMALGAMATING METRIC AND IMPERIAL SIZES WHERE POSSIBLE, THIS  
 SPECIFICATION PROVIDES FOR MAXIMUM UTILISATION WITH MINIMUM  
 INVENTORY, WITHOUT SACRIFICING PERFORMANCE. STOCKED RANGE  
 ADDITIONAL TO PLAIN FINISH INCLUDES: ZINC ELECTROPLATED,  
 MECHANICALLY GALVANISED TO ASTM B695 CLASS 65

Nominal Bolt Size	Inside Diameter		Outside Diameter		Thickness			Pieces per box	Inner Bags
	Min.	Max.	Min.	Max.	Nom.	Min.	Max.		
M5	5.5	5.8	12.0	12.7	1.4	1.2	1.6	15000	30 x 500
M6	6.7	7.1	16.0	17.0	1.4	1.2	1.6	7500	15 x 500
M8	8.8	9.3	19.0	20.0	1.6	1.4	1.8	5000	10 x 500
M10	10.5	11.0	22.5	23.5	2.0	1.8	2.2	2500	5 x 500
7/16"	12.0	12.7	25.4	26.5	2.0	1.8	2.2	2500	10 x 250
M12	13.2	14.0	27.5	28.5	2.25	2.0	2.5	2000	10 x 200
M16	17.2	18.0	33.5	34.5	2.75	2.5	3.0	1000	5 x 200
M20	21.0	22.0	38.0	39.5	3.0	2.6	3.2	750	5 x 150
7/8"	23.5	24.5	46.5	48.0	3.0	2.8	3.5	500	10 x 500
M24	26.0	27.0	52.0	54.2	4.0	3.5	4.2	250	10 x 25
1.1/8"	31.0	32.5	62.0	64.0	4.0	3.5	4.2	200	8 x 25
M30	33.0	34.5	58.0	60.0	4.0	3.5	4.2	250	10 x 25
1.1/4"	35.0	36.5	63.0	66.0	4.0	3.5	4.2	200	8 x 25
M36	39.0	40.5	70.0	73.0	5.0	4.5	5.2	125	5 x 25
1.1/2"	41.0	43.0	77.0	80.0	5.0	4.8	5.5	100	10 x 10
M42	45.0	46.0	77.0	80.0	5.0	4.8	5.2	100	10 x 10
1.3/4"	48.0	51.0	90.0	93.0	6.0	5.6	6.4	70	7 x 10
M48	51.0	53.5	90.0	93.0	6.0	5.6	6.4	70	7 x 10
2"	54.0	55.0	100.0	105.0	6.0	5.6	6.4	50	5 x 10
M56	61.5	63.0	118.0	125.0	7.0	6.6	7.4	30	3 x 10
M64	69.5	71.0	118.0	125.0	7.0	6.6	7.4	30	3 x 10

**Application:** For direct-tension indication tightening of Bremick Fasteners

**High Strength Structural Bolts (AS1252).**

Structural Load Indicating Washers are designed for use with Bremick high strength structural bolts and provide a simple and accurate aid to tightening and inspection. The washers provide a direct indication of correct installed bolt tension which complies with AS4100.

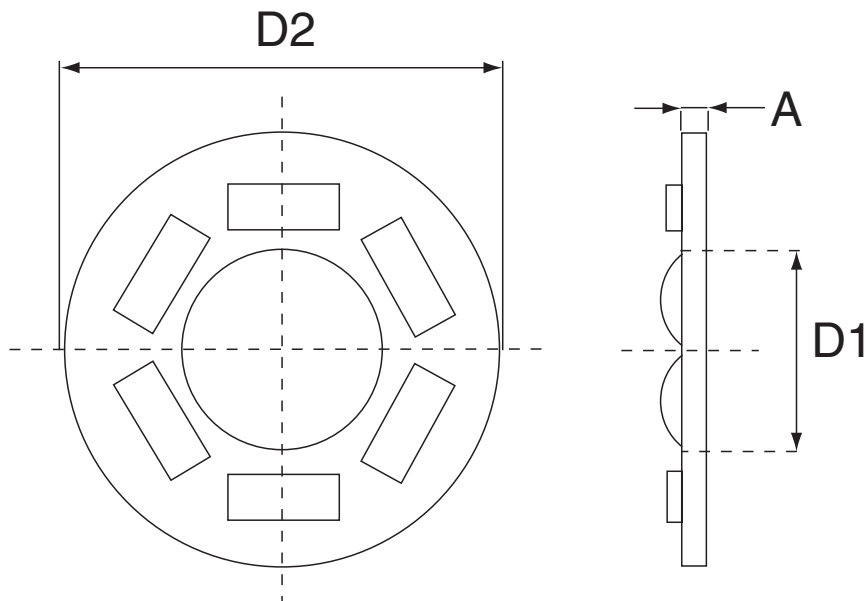

Figure 1

The Load Indicating Washers are special hardened washers carrying 4 to 7 protrusions, depending on bolt diameter (Figure 1) and these are assembled with the protrusions bearing against the underside of the bolt head, leaving a gap. The nut is then tightened until the protrusions are flattened and the gap reduced to that shown in Table 1. Refer to Figure 2 for an example of before and after tightening. Note that the bolt head must remain stationary during tightening.

# INSTALLATION USING STRUCTURAL LOAD INDICATING WASHERS (AKA CORONET LOAD INDICATORS)

The induced bolt tension at this average gap will be not less than the minimum specified tension in Table 2.

In applications where the bolt head is not visible for inspection or it is necessary to rotate the bolt head rather than the nut in tightening, the Load Indicating Washer can be fitted under the nut using an extra hard flat round washer under the nut and protrusions bear against this washer (Figure 3).

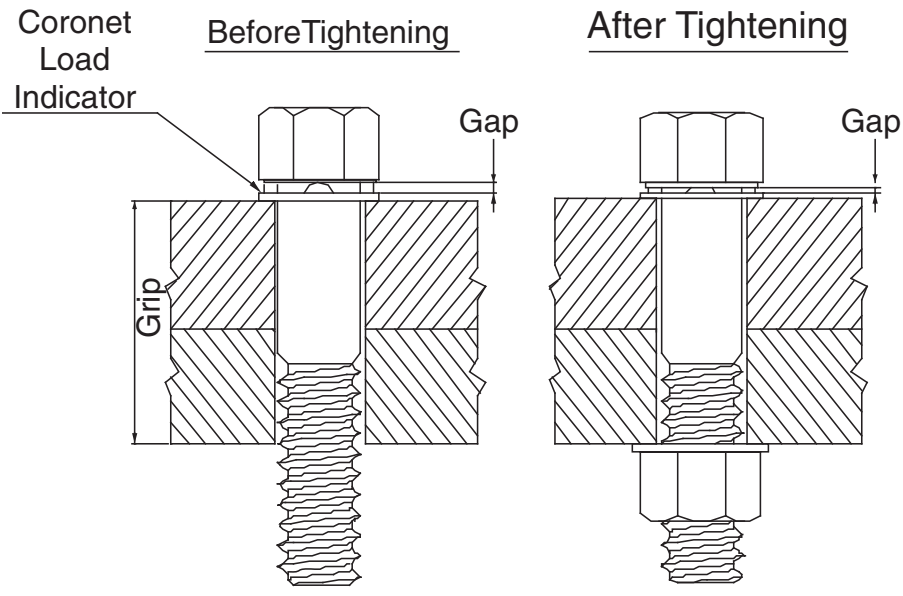

Figure 2

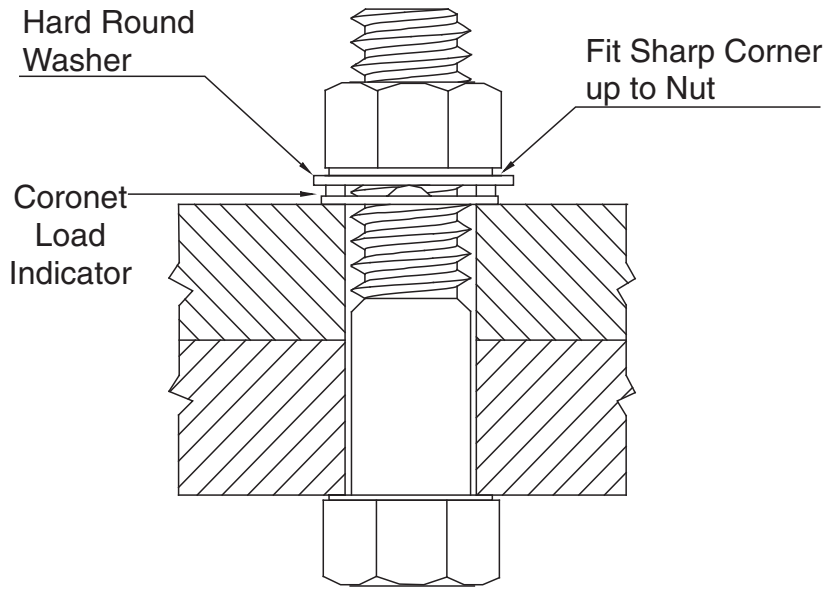

Figure 3



## INSTALLATION USING STRUCTURAL LOAD INDICATING WASHERS (AKA CORONET LOAD INDICATORS)



In tightening with Load Indicating Washers it is still required that this tightening be carried out in two stages. First stage involves a preliminary tightening to a “snug fit” condition. The object of this preliminary tightening is to draw the mating surfaces into firm contact. The use of drift pins is also recommended to maintain hole alignment.

On large joints take a second run to ensure that all bolts are “snug fit”. Carry out final tightening by reducing gap between bolt head and load indicator to 0.40mm or less. A feeler gauge of the specified thickness is used as an inspection tool, however experienced operators will judge the gap by eye. Final tightening should begin at the most rigid part of the connection towards the free edges to minimise any subsequent relaxation of previously tightened fasteners.

If the gap is closed completely, over-tightening has occurred, but should not be detrimental to 8.8/TF and 8.8/TB assemblies.

In the event that the gap does not close evenly, the average gap should be estimated, and should conform with the specified dimension (Figure 4).

When gap is not uniform, the average gap should be measured midway between the maximum and minimum gaps with feeler gauge.

If feeler gauge does not enter gap at this point, bolt is properly tightened.

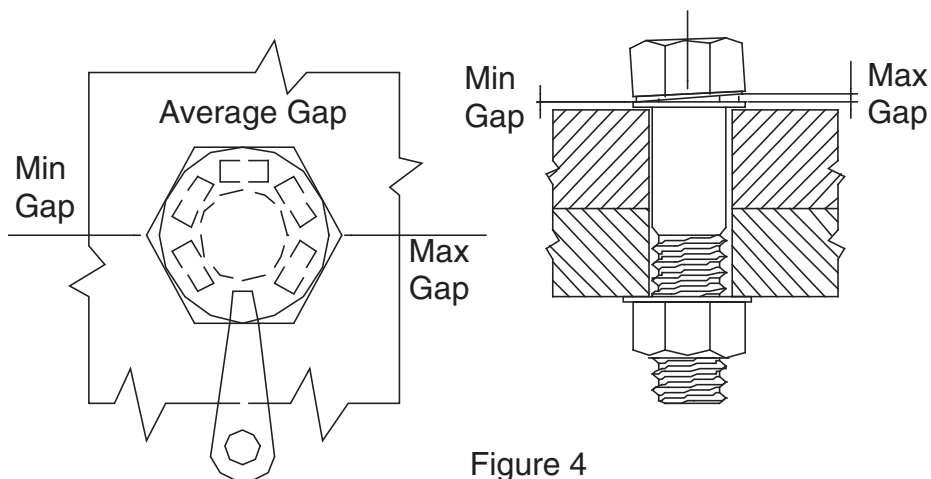

Figure 4

**Important:** A nut should not be slacked after fully tightening with a Load Indicating Washer. If this is necessary, fit a new Load Indicating Washer for the second tightening.



## INSTALLATION USING STRUCTURAL LOAD INDICATING WASHERS (AKA CORONET LOAD INDICATORS)

Table 1

Load Indicator gaps to give required minimum shank tension

Position of Load Indicating Washer	Gap (mm)
Under bolt head, black finish bolts	0.4
Under bolt head, hot dip galvanised bolts	0.25
Under nut, with hardened washer, all finishes	0.25

Table 2

Nominal Bolt Diameter	Outside Diameter D2	Inside Diameter D1	Thickness A Max	Minimum Bolt Tension kN
M16	35.45	16.7	4.26	95
M20	41.67	20.84	4.26	145
M24	50.69	24.84	4.26	210
M30	59.59	30.84	4.26	335

All dimensions in mm

# SUMMARY OF TRADING TERMS



**A full set of our current conditions is available on request**

## Payment/Credits

Our trading terms are 30 days from statement date.  
Consignment stock is not available.

Returns for credit are subject to prior approval and allocation of an acceptance number, without which our warehouse is directed not to receive them. Receipt of goods in this way does not imply agreement to issue a credit note.

Approval of credit can only be considered if the request for credit in writing is received (within 14 days of receipt of goods) showing the credit acceptance number, original invoice number, date and reason for return.

No freight charges for return of goods shall be accepted unless authorised by Bremick.

Products which have been reworked, specially manufactured or zinc plated cannot be returned.

## Romalpa Clause

1. Notwithstanding anything in these Conditions of Sale contained, expressed or implied or incorporated herein by reference and notwithstanding any rule of law or equity to the contrary and notwithstanding any course of dealing between the Company and the Purchaser, property in goods shall not pass from the Company to the Purchaser unless and until –
  - (a) Such goods have been delivered in accordance with these conditions and
  - (b) The Purchaser shall have made payment in full for such goods ("the goods") and

(c) The Purchaser shall have fully discharged all their indebtedness and other liability (if any) of the Purchaser to the Company on whatsoever account. The Purchaser shall, notwithstanding the foregoing, be empowered as the agent of the Company to sell the goods and shall hold the proceeds of such sale upon trust to apply the same, firstly in payment or otherwise discharging the payable to the Company for such goods and any other costs of carriage or insurance or other costs or expenses borne by the Company in respect thereof; secondly, in paying or otherwise discharging all the other indebtedness or liability (if any) of the Purchaser to the Company on whatsoever account, which is outstanding at the date that the Purchaser receives such proceeds of sale; thirdly, as to any balance, for the Purchaser's own use and benefit. Pending the passing of title to the goods the Company may require the Purchaser to mark the goods as being the property of the Company.

**This catalogue has been produced by Bremick Pty Ltd, A.B.N 68 000 496 131. All care was taken in its preparation, however Bremick accepts no responsibility for the accuracy of information it contains. Copyright 2013.**

## Disclaimer

- This document is published and distributed to provide general guidelines on products.
- Bremick Pty Ltd hereby advise the users of products contained herein to make their own enquiries of individual respective manufacturers in respect of the particular specific applications which those users propose for these products.
- Bremick Pty Ltd takes no responsibility at all for the use or misuse of those products in any way.

This publication is distributed on the terms and understanding that the authors, consultants and the publisher expressly disclaim all and any liability and responsibility to any person, whether a reader of this publications or not, in respect of any thing and or the consequences of any thing done or omitted to be done by any such person in reliance, whether wholly or partially, upon the whole or any part of the contents of this publication. Without limiting the generality of the above, no author, consultant or publisher shall have any

responsibility for any act or omission of any other author, consultant or publisher. All rights reserved. No part of this work that is covered by copyright may be reproduced or copied in any form or by any means (including but not limited to graphic, electronic or mechanical. Including photocopying, recording, recording and taping, or in information retrieval systems) without the written permission of Bremick Pty Limited, which permission may in the absolute discretion of Bremick Pty Limited be withheld.

## Contact Details

### Australia

#### National Distribution Centre

Administration  
PO Box 6070  
Alexandria NSW 2015  
Ph + 61 (0) 2 8332 1501  
Fax + 61 (0) 2 9690 1474

#### New South Wales & ACT

Unit F1, 62 Maddox Street  
Alexandria NSW 2015  
Ph + 61 (0) 2 8332 1500  
Fax + 61 (0) 2 9319 2303  
Toll free 1800 252 922  
Email: sales@bremick.com.au

#### Victoria, SA & TAS

50 Glenvale Crescent  
Mulgrave VIC 3170  
Ph + 61 (0) 3 9561 1700  
Fax + 61 (0) 3 9561 1722  
Toll free 1800 061 889  
Email: vicsales@bremick.com.au

#### Queensland (South & Central)

16 Parkview Drive  
Archerfield QLD 4108  
Ph + 61 (0) 7 3277 9233  
Fax + 61 (0) 7 3277 9255  
Toll free 1800 061 245  
Email: sthqldsales@bremick.com.au

#### Queensland (North)

Unit 1, 34-36 Auscan Crescent  
Garbutt QLD 4814  
Ph + 61 (0) 7 4728 9070  
Fax + 61 (0) 7 4728 9061  
Toll free 1800 061 034  
Email: nthqldsales@bremick.com.au

#### Western Australia

119 Motivation Drive  
Wangara WA 6065  
Ph + 61 (0) 8 9302 5255  
Fax + 61 (0) 8 9303 4802  
Toll free 1800 607 499  
Email: wasales@bremick.com.au

### Northern Territory

11 Cato Street  
Winnellie NT 0820  
Ph + 61 (0) 8 8947 1477  
Fax + 61 (0) 8 8947 0601  
Toll free 1800 609 699  
Email: ntsales@bremick.com.au

### South Australia

2 Lafitte Road  
Wingfield SA 5013  
Ph + 61 (0) 8 8359 6900  
Fax + 61 (0) 8 8359 1611  
Toll free 1800 192 300  
Email: sasales@bremick.com.au

### New Zealand

#### North Island

126 Hugo Johnston Drive  
Penrose  
Ph + 64 (0) 9 525 2244  
Fax + 64 (0) 9 525 1992  
Toll free 0800 658 075  
Email: nthnzsales@bremick.com.au

#### South Island

5-7 Lunns Road  
Middleton, Christchurch  
Ph + 64 (0) 3 365 8998  
Fax + 64 (0) 3 365 8538  
Toll free 0800 106 670  
Email: sthnzsales@bremick.com.au

### Export Enquiries

export@bremick.com.au

Whilst every care was taken in the preparation of this guide, Bremick accepts no responsibility for the accuracy of the information supplied. The contents of this brochure are exclusive copyright of Bremick Fasteners and may not be reproduced without permission.



PPRINDAU141