

SECURITY FIXINGS THAT NEVER LET GO



EDITION



5

STOCK
PRODUCT
GUIDE

www.sentinelgrp.com.au



SECURITY & ARCHITECTURAL FASTENERS

	RESYTORK SECURITY SCREWS	3	LEVEL 1: Basic Security 
	RESYTORK BARREL NUTS	33	LEVEL 1: Basic Security 
	PENTAFORCE™ SECURITY SCREWS	38	LEVEL 2: High Security 
	PIN HEX SECURITY SCREWS	50	LEVEL 1: Basic Security 
	CLUTCH HEAD SECURITY SCREWS	70	LEVEL 3: Max. Security 
	SENTINEL SECURITY SCREWS	78	LEVEL 3: Max. Security 
	2 HOLE SECURITY SCREWS	84	LEVEL 1: Basic Security 
	TORXPLUS SECURITY SCREWS	94	LEVEL 1: Basic Security 
	TRI-LOBULAR SECURITY SCREWS	98	LEVEL 1: Basic Security 
	OVAL PAN HEAD SECURITY SCREWS	100	LEVEL 3: Max. Security 
	QUADTECH™ SECURITY SCREWS	102	LEVEL 1: Basic Security 
	UNISET SECURITY SCREWS	104	LEVEL 3: Max. Security 
	KINMAR™ REMOVABLE NUTS	106	LEVEL 2: High Security 
	KINMAR™ PERMANENT NUTS	108	LEVEL 3: Max. Security 
	KINMAR™ REMOVABLE BOLTS	110	LEVEL 2: High Security 
	KINMAR™ PERMANENT BOLTS	111	LEVEL 3: Max. Security 
	SHEAR NUTS & BOLTS	112	LEVEL 3: Max. Security 
	ARMOUR RINGS	116	LEVEL 3: Max. Security 
	STELLAR™ FASTENING SYSTEM	118	LEVEL 2: High Security 

	SLAB TEE NUT	119	LEVEL 3: Max. Security 
	TRIDENT NUT	119	LEVEL 1: Basic Security 
	NO-GO™ SECURITY ENCLOSURES	120	LEVEL 3: Max. Security 
	PYRANUT SECURITY SCREWS	121	LEVEL 1: Basic Security 
	SCROLL NUTS	122	LEVEL 2: High Security 
	SCREWBOLTS	124	LEVEL 3: Max. Security 
	FASTDRIVE™ CONCRETE ANCHORS	127	LEVEL 3: Max. Security 
	RESYTORK SLEEVE ANCHORS	128	LEVEL 1: Basic Security 
	KINMAR™ REMOVABLE SLEEVE ANCHORS	130	LEVEL 2: High Security 
	KINMAR™ PERMANENT SLEEVE ANCHORS	131	LEVEL 3: Max. Security 
	4-HOLE NUT & BOLT SYSTEM	132	LEVEL 3: Max. Security 
	TRI-HEAD SECURITY SCREWS	133	LEVEL 2: High Security 

SECURITY TOOLING **134**

MERCHANDISER STAND **139**

MADE TO MEASURE SPECIALS **141**

APPLICATION ADVICE **142**

PROMOTIONAL **144**

TECHNICAL INFORMATION **146**

GOODS RETURN FORM **149**

ACCOUNT APPLICATION **150**

Every effort has been made to ensure the accuracy of accuracy of information provided in this catalogue. Sentinel Group cannot warrant the information however, expressly or implied, and any liability arising from it is expressly excluded. Customers must satisfy themselves as to the suitability of products and the technical information relating to them, and it is recommended that you conduct your own tests to establish suitability. This does not effect your statutory rights.

RESYTORK COUNTERSUNK MACHINE SCREWS

Undercut and raised countersunk heads available in selected sizes. Other special head shapes can be custom manufactured to suit specific projects.

Precision manufactured in 304 Stainless steel. 316 Stainless steel, Zinc and Galvanised versions can be produced on request.

Imperial threads available see page 5

Pin in recess to resist tampering.

6 Lobe high torque drive with chamfer to assist driver tool insertion.

LEVEL 1:
Basic Security

Can be installed and removed with the following tools:

- Insert Bit
- Key Wrench
- Screwdriver

See page 134 - For more details on Driver Tools



PART NO.	LENGTH	DRIVE SIZE	HEAD DIA	HEAD HEIGHT	MATERIAL	\$/100
RTCM306	6mm	T10	5.9mm	2mm	304 S/S	\$71.10
RTCM308	8mm	T10	5.9mm	2mm	304 S/S	\$92.20
RTCM310	10mm	T10	5.9mm	2mm	304 S/S	\$92.70
RTCM312	12mm	T10	5.9mm	2mm	304 S/S	\$96.00
RTCM316	16mm	T10	5.9mm	2mm	304 S/S	\$99.80
RTCM320	20mm	T10	5.9mm	2mm	304 S/S	\$103.70
RTCM325	25mm	T10	5.9mm	2mm	304 S/S	\$124.00



RESYTORK COUNTERSUNK MACHINE SCREWS

Undercut and raised countersunk heads available in selected sizes. Other special head shapes can be custom manufactured to suit specific projects.

Precision manufactured in 304 Stainless steel, 316 Stainless steel, Zinc and Galvanised versions can be produced on request.

Imperial threads available see page 5

Pin in recess to resist tampering.

6 Lobe high torque drive with chamfer to assist driver tool insertion.

LEVEL 1:
Basic Security

Can be installed and removed with the following tools:

Insert Bit

Key Wrench

Screwdriver

See page 134 - For more details on Driver Tools



○ = Zinc Plated

PART NO.	LENGTH	DRIVE SIZE	HEAD DIA	HEAD HEIGHT	MATERIAL	\$/100	
RTCM408	8mm	T20	7.8mm	2.3mm	304 S/S	\$77.00	
RTCM408-Z	8mm	T20	7.5mm	2.2mm	Zinc plated	\$40.00	○
RTCM410	10mm	T20	7.8mm	2.3mm	304 S/S	\$78.10	
RTCM410-Z	10mm	T20	7.5mm	2.2mm	Zinc plated	\$46.80	○
RTCM412	12mm	T20	7.8mm	2.3mm	304 S/S	\$79.60	
RTCM412-Z	12mm	T20	7.5mm	2.2mm	Zinc plated	\$48.00	○
RTCM416	16mm	T20	7.8mm	2.3mm	304 S/S	\$82.60	
RTCM416-Z	16mm	T20	7.5mm	2.2mm	Zinc plated	\$49.50	○
RTCM420	20mm	T20	7.8mm	2.3mm	304 S/S	\$88.20	
RTCM420-Z	20mm	T20	7.5mm	2.2mm	Zinc plated	\$38.80	○
RTCM425	25mm	T20	7.8mm	2.3mm	304 S/S	\$95.10	
RTCM430	30mm	T20	7.8mm	2.3mm	304 S/S	\$100.00	
RTCM430-Z	30mm	T20	7.5mm	2.2mm	Zinc plated	\$42.50	○
RTCM435	35mm	T20	7.8mm	2.3mm	304 S/S	\$187.50	
RTCM440	40mm	T20	7.8mm	2.3mm	304 S/S	\$152.00	
RTCM450	50mm	T20	7.8mm	2.3mm	304 S/S	\$175.00	
RTCM470	70mm	T20	7.8mm	2.3mm	304 S/S	\$198.00	

Other sizes of Zinc plated screws also available by special order.
Contact Our Sales Team To Find Out More

We can supply broken packs; just add 20% to the price.

RESYTORK COUNTERSUNK MACHINE SCREWS

Undercut and raised countersunk heads available in selected sizes. Other special head shapes can be custom manufactured to suit specific projects.

Precision manufactured in 304 Stainless steel, 316 Stainless steel, Zinc and Galvanised versions can be produced on request.

Imperial threads available see page 5

Pin in recess to resist tampering.

6 Lobe high torque drive with chamfer to assist driver tool insertion.

LEVEL 1:
Basic Security

Can be installed and removed with the following tools:

Insert Bit

Key Wrench

Screwdriver

See page 134 - For more details on Driver Tools



○ = Zinc Plated

PART NO.	LENGTH	DRIVE SIZE	HEAD DIA	HEAD HEIGHT	MATERIAL	\$/100
RTCM508	8mm	T25	9.8mm	2.3mm	304 S/S	\$99.00
RTCM508-Z	8mm	T25	9.3mm	2.5mm	Zinc Plated	\$45.50
RTCM510	10mm	T25	9.8mm	2.3mm	304 S/S	\$101.20
RTCM510-Z	10mm	T25	9.3mm	2.5mm	Zinc Plated	\$54.00
RTCM512	12mm	T25	9.8mm	2.3mm	304 S/S	\$103.90
RTCM512-Z	12mm	T25	9.3mm	2.5mm	Zinc Plated	\$57.00
RTCM516	16mm	T25	9.8mm	2.3mm	304 S/S	\$109.40
RTCM516-Z	16mm	T25	9.3mm	2.5mm	Zinc Plated	\$69.50
RTCM520	20mm	T25	9.8mm	2.3mm	304 S/S	\$116.70
RTCM520-Z	20mm	T25	9.3mm	2.5mm	Zinc Plated	\$55.00
RTCM525	25mm	T25	9.8mm	2.3mm	304 S/S	\$131.60
RTCM525-Z	25mm	T25	9.3mm	2.5mm	Zinc Plated	\$62.80
RTCM530	30mm	T25	9.8mm	2.3mm	304 S/S	\$139.80
RTCM530-Z	30mm	T25	9.3mm	2.5mm	Zinc Plated	\$64.00
RTCM535	35mm	T25	9.8mm	2.3mm	304 S/S	\$182.00
RTCM540	40mm	T25	9.8mm	2.3mm	304 S/S	\$164.40
RTCM550	50mm	T25	9.8mm	2.3mm	304 S/S	\$183.90
RTCM580	80mm	T25	9.8mm	2.3mm	304 S/S	\$268.00

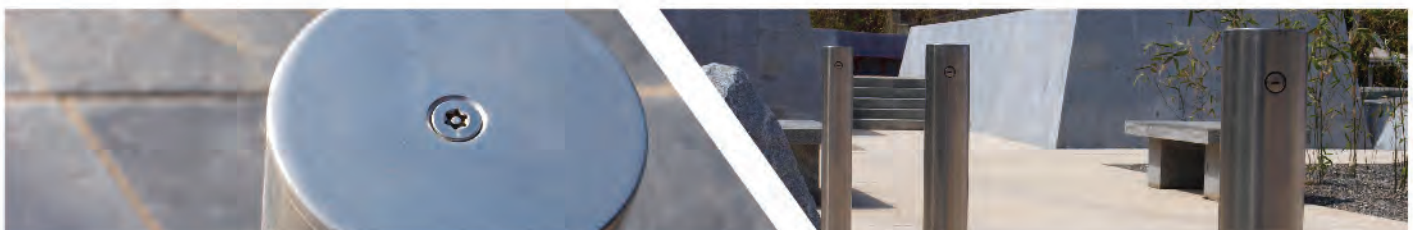

RESYTORK COUNTERSUNK MACHINE SCREWS

Undercut and raised countersunk heads available in selected sizes. Other special head shapes can be custom manufactured to suit specific projects.

Precision manufactured in 304 Stainless steel. 316 Stainless steel, Zinc and Galvanised versions can be produced on request.

Imperial threads available see page 5

Pin in recess to resist tampering.

6 Lobe high torque drive with chamfer to assist driver tool insertion.

LEVEL 1:
Basic Security

Can be installed and removed with the following tools:

Insert Bit

Key Wrench

Screwdriver

See page 134 - For more details on Driver Tools



● = 316 S/S
○ = Zinc Plated

PART NO.	LENGTH	DRIVE SIZE	HEAD DIA	HEAD HEIGHT	MATERIAL	\$/100
RTCM608	8mm	T30	11.8mm	3.3mm	304 S/S	\$116.00
RTCM610	10mm	T30	11.8mm	3.3mm	304 S/S	\$122.90
RTCM610-Z	10mm	T30	11mm	3mm	Zinc Plated	\$65.25 ○
RTCM612	12mm	T30	11.8mm	3.3mm	304 S/S	\$123.40
RTCM612-Z	12mm	T30	11mm	3mm	Zinc Plated	\$74.80 ○
RTCM616	16mm	T30	11.8mm	3.3mm	304 S/S	\$125.20
RTCM616-Z	16mm	T30	11mm	3mm	Zinc Plated	\$78.20 ○
RTCM620	20mm	T30	11.8mm	3.3mm	304 S/S	\$135.10
RTCM620-A4	20mm	T30	11.8mm	3.3mm	316 S/S	\$450.00 ●
RTCM620-Z	20mm	T30	11mm	3mm	Zinc Plated	\$79.25 ○
RTCM625	25mm	T30	11.8mm	3.3mm	304 S/S	\$155.10
RTCM630	30mm	T30	11.8mm	3.3mm	304 S/S	\$165.40
RTCM635	35mm	T30	11.8mm	3.3mm	304 S/S	\$182.80
RTCM640	40mm	T30	11.8mm	3.3mm	304 S/S	\$192.30
RTCM650	50mm	T30	11.8mm	3.3mm	304 S/S	\$214.10
RTCM660	60mm	T30	11.8mm	3.3mm	304 S/S	\$220.00
RTCM675	75mm	T30	11.8mm	3.3mm	304 S/S	\$235.00
RTCM680	80mm	T30	11.8mm	3.3mm	304 S/S	\$245.00



RESYTORK COUNTERSUNK MACHINE SCREWS

Undercut and raised countersunk heads available in selected sizes. Other special head shapes can be custom manufactured to suit specific projects.

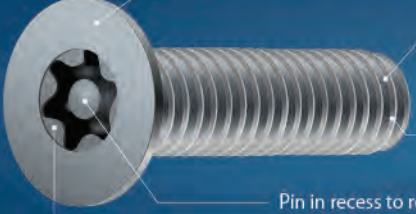

Precision manufactured in 304 Stainless steel, 316 Stainless steel, Zinc and Galvanised versions can be produced on request.

Imperial threads available see page 5



Pin in recess to resist tampering.

6 Lobe high torque drive with chamfer to assist driver tool insertion.

LEVEL 1:
Basic Security



Can be installed and removed with the following tools:

-  Insert Bit
-  Key Wrench
-  Screwdriver

See page 134 - For more details on Driver Tools

M8



PART NO.	LENGTH	DRIVE SIZE	HEAD DIA	HEAD HEIGHT	MATERIAL	\$/100
RTCM810	10mm	T40	14mm	4.7mm	304 S/S	\$262.50
RTCM816	16mm	T40	14mm	4.7mm	304 S/S	\$248.50
RTCM820	20mm	T40	14mm	4.7mm	304 S/S	\$282.00
RTCM825	25mm	T40	14mm	4.7mm	304 S/S	\$305.50
RTCM830	30mm	T40	14mm	4.7mm	304 S/S	\$330.90
RTCM840	40mm	T40	14mm	4.7mm	304 S/S	\$387.70
RTCM850	50mm	T40	14mm	4.7mm	304 S/S	\$430.90
RTCM860	60mm	T40	14mm	4.7mm	304 S/S	\$449.00
RTCM880	80mm	T40	14mm	4.7mm	304 S/S	\$455.00

M10





PART NO.	LENGTH	DRIVE SIZE	HEAD DIA	HEAD HEIGHT	MATERIAL	\$/100
RTCM1020	20mm	T45	17.3mm	6.3mm	304 S/S	\$410.00
RTCM1030	30mm	T45	17.3mm	6.3mm	304 S/S	\$440.00
RTCM1060	60mm	T45	17.3mm	6.3mm	304 S/S	\$620.00
RTCM1080	80mm	T45	17.3mm	6.3mm	304 S/S	\$730.00

We can supply broken packs; just add 20% to the price.

M12 sizes can be made to order.

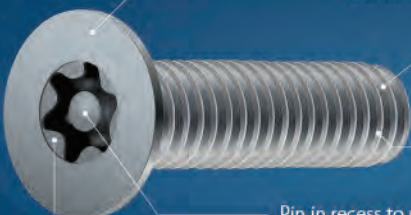
RESYTORK COUNTERSUNK MACHINE SCREWS



Countersunk head seats flush with material. Undercut heads available in selected sizes.

Precision manufactured in 304 Stainless steel. 316 Stainless steel, Zinc and Galvanised versions can be produced on request.

Metric threads available see pages 1-4



Pin in recess to resist tampering.

6 Lobe high torque drive with chamfer to assist driver tool insertion.

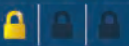
LEVEL 1:
Basic Security



Can be installed and removed with the following tools:

-  Insert Bit
-  Key Wrench
-  Screwdriver

See page 134 - For more details on Driver Tools

6-32 UNC



PART NO.	LENGTH	DRIVE SIZE	HEAD DIA	HEAD HEIGHT	MATERIAL	\$/100
RTCM632AU	1/4" (7mm)	T10	6.35mm	Undercut	304 S/S	\$104.00
RTCM632C	3/8" (9.5mm)	T15	6.35mm	2.5mm	304 S/S	\$104.00
RTCM632D	1/2" (13mm)	T15	6.35mm	2.5mm	304 S/S	\$106.00
RTCM632F	3/4" (19mm)	T15	6.35mm	2.5mm	304 S/S	\$120.00
RTCM632G	1" (25mm)	T15	6.35mm	2.5mm	304 S/S	\$134.00
RTCM632I	1 1/2" (38mm)	T15	6.35mm	2.5mm	304 S/S	\$138.00

8-32 UNC



PART NO.	LENGTH	DRIVE SIZE	HEAD DIA	HEAD HEIGHT	MATERIAL	\$/100
RTCM832AU	1/4" (7mm)	T15	7.5mm	Undercut	304 S/S	\$108.00
RTCM832C	3/8" (9.5mm)	T20	7.5mm	3mm	304 S/S	\$108.00
RTCM832D	1/2" (13mm)	T20	7.5mm	3mm	304 S/S	\$112.00
RTCM832F	3/4" (19mm)	T20	7.5mm	3mm	304 S/S	\$119.00
RTCM832G	1" (25mm)	T20	7.5mm	3mm	304 S/S	\$126.00
RTCM832H	1 1/4" (32mm)	T20	7.5mm	3mm	304 S/S	\$138.00
RTCM832I	1 1/2" (38mm)	T20	7.5mm	3mm	304 S/S	\$146.00

RESYTORK COUNTERSUNK MACHINE SCREWS

Countersunk head seats flush with material. Undercut heads available in selected sizes.

Precision manufactured in 304 Stainless steel. 316 Stainless steel, Zinc and Galvanised versions can be produced on request.

Metric threads available see pages 1-4

Pin in recess to resist tampering.

6 Lobe high torque drive with chamfer to assist driver tool insertion.

LEVEL 1:
Basic Security

Can be installed and removed with the following tools:

- Insert Bit
- Key Wrench
- Screwdriver

See page 134 - For more details on Driver Tools

10-24 UNC

PART NO.	LENGTH	DRIVE SIZE	HEAD DIA	HEAD HEIGHT	MATERIAL	\$/100
RTCM1024C	3/8" (9.5mm)	T25	9.0mm	3.5mm	304 S/S	\$128.00
RTCM1024D	1/2" (13mm)	T25	9.0mm	3.5mm	304 S/S	\$136.00
RTCM1024E	5/8" (16mm)	T25	9.0mm	3.5mm	304 S/S	\$144.00
RTCM1024F	3/4" (19mm)	T25	9.0mm	3.5mm	304 S/S	\$152.00
RTCM1024G	1" (25mm)	T25	9.0mm	3.5mm	304 S/S	\$156.00
RTCM1024H	1 1/4" (32mm)	T25	9.0mm	3.5mm	304 S/S	\$172.00
RTCM1024I	1 1/2" (38mm)	T25	9.0mm	3.5mm	304 S/S	\$189.00
RTCM1024J	2" (50mm)	T25	9.0mm	3.5mm	304 S/S	\$210.00

10-32 UNF

PART NO.	LENGTH	DRIVE SIZE	HEAD DIA	HEAD HEIGHT	MATERIAL	\$/100
RTCM1032C	3/8" (9.5mm)	T25	9.0mm	3.5mm	304 S/S	\$128.00
RTCM1032D	1/2" (13mm)	T25	9.0mm	3.5mm	304 S/S	\$136.00
RTCM1032F	3/4" (19mm)	T25	9.0mm	3.5mm	304 S/S	\$152.00
RTCM1032G	1" (25mm)	T25	9.0mm	3.5mm	304 S/S	\$156.00
RTCM1032H	1 1/4" (32mm)	T25	9.0mm	3.5mm	304 S/S	\$172.00
RTCM1032I	1 1/2" (38mm)	T25	9.0mm	3.5mm	304 S/S	\$189.00

We can supply broken packs; just add 20% to the price.

RESYTORK COUNTERSUNK MACHINE SCREWS

Countersunk head seats flush with material. Undercut heads available in selected sizes.

Precision manufactured in 304 Stainless steel, 316 Stainless steel, Zinc and Galvanised versions can be produced on request.

Metric threads available see pages 1-4

Pin in recess to resist tampering.

6 Lobe high torque drive with chamfer to assist driver tool insertion.

LEVEL 1:
Basic Security

Can be installed and removed with the following tools:

Insert Bit

Key Wrench

Screwdriver

See page 134 - For more details on Driver Tools

1/4-20 UNC

PART NO.	LENGTH	DRIVE SIZE	HEAD DIA	HEAD HEIGHT	MATERIAL	\$/100
RTCM1/4CU	3/8" (9.5mm)	T27	11mm	Undercut	304 S/S	\$206.00
RTCM1/4DU	1/2" (12mm)	T27	11mm	Undercut	304 S/S	\$190.00
RTCM1/4E	5/8" (16mm)	T30	11mm	3.2mm	304 S/S	\$196.00
RTCM1/4F	3/4" (19mm)	T30	11mm	3.2mm	304 S/S	\$212.00
RTCM1/4G	1" (25mm)	T30	11mm	3.2mm	304 S/S	\$236.00
RTCM1/4H	1 1/4" (32mm)	T30	11mm	3.2mm	304 S/S	\$248.00
RTCM1/4I	1 1/2" (38mm)	T30	11mm	3.2mm	304 S/S	\$252.00
RTCM1/4J	2" (50mm)	T30	11mm	3.2mm	304 S/S	\$420.00

RESYTORK RAISED HEAD COUNTERSUNK MACHINE SCREWS

Raised countersunk head eliminates side movement of material and provides visually pleasing dome.

Precision manufactured in 304 Stainless steel.

Pin in recess to resist tampering.

6 Lobe high torque drive with chamfer to assist driver tool insertion.

LEVEL 1:
Basic Security

M3.5

PART NO.	LENGTH	DRIVE SIZE	HEAD DIA	HEAD HEIGHT	MATERIAL	\$/100
RTOM3512	12mm	T10	6.5mm	1.8mm	304 S/S	\$133.60
RTOM3520	20mm	T10	6.5mm	1.8mm	304 S/S	\$135.00
RTOM3525	25mm	T10	6.5mm	1.8mm	304 S/S	\$138.20
RTOM3530	30mm	T10	6.5mm	1.8mm	304 S/S	\$142.70
RTOM3540	40mm	T10	6.5mm	1.8mm	304 S/S	\$147.10
RTOM3550	50mm	T10	6.5mm	1.8mm	304 S/S	\$156.10
RTOM3575	75mm	T10	6.5mm	1.8mm	304 S/S	\$188.90

RESYTORK BUTTON HEAD MACHINE SCREWS

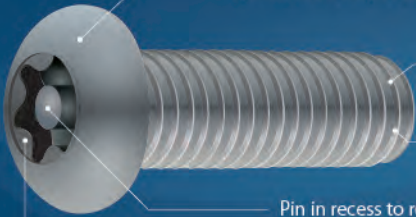

Domed button head shape has excellent visual effect and safety benefits. Other special head shapes can be custom manufactured to suit specific projects.

Precision manufactured in 304 Stainless steel. 316 Stainless steel, Zinc and Galvanised versions can be produced on request.

Imperial threads available see page 13

Pin in recess to resist tampering.

6 Lobe high torque drive with chamfer to assist driver tool insertion.

LEVEL 1:
Basic Security







Can be installed and removed with the following tools:

-  Insert Bit
-  Key Wrench
-  Screwdriver

See page 134 - For more details on Driver Tools



PART NO.	LENGTH 	DRIVE SIZE 	HEAD DIA 	HEAD HEIGHT 	MATERIAL 	\$/100 
RTBM305	5mm	T10	5.5mm	1.7mm	304 S/S	\$69.00
RTBM306	6mm	T10	5.5mm	1.7mm	304 S/S	\$71.10
RTBM308	8mm	T10	5.5mm	1.7mm	304 S/S	\$73.70
RTBM310	10mm	T10	5.5mm	1.7mm	304 S/S	\$74.20
RTBM312	12mm	T10	5.5mm	1.7mm	304 S/S	\$76.80
RTBM314	14mm	T10	5.5mm	1.7mm	304 S/S	\$77.80
RTBM316	16mm	T10	5.5mm	1.7mm	304 S/S	\$79.80
RTBM320	20mm	T10	5.5mm	1.7mm	304 S/S	\$83.00
RTBM325	25mm	T10	5.5mm	1.7mm	304 S/S	\$89.00



RESYTORK BUTTON HEAD MACHINE SCREWS

Domed button head shape has excellent visual effect and safety benefits. Other special head shapes can be custom manufactured to suit specific projects.

Precision manufactured in 304 Stainless steel, 316 Stainless steel, Zinc and Galvanised versions can be produced on request.

Imperial threads available see page 13

Pin in recess to resist tampering.

6 Lobe high torque drive with chamfer to assist driver tool insertion.

LEVEL 1:
Basic Security

Can be installed and removed with the following tools:

- Insert Bit
- Key Wrench
- Screwdriver

See page 134 - For more details on Driver Tools



○ = Zinc Plated

PART NO.	LENGTH 	DRIVE SIZE 	HEAD DIA 	HEAD HEIGHT 	MATERIAL 	\$/100 	
RTBM406	6mm	T20	7.4mm	2.1mm	304 S/S	\$74.50	
RTBM408	8mm	T20	7.4mm	2.1mm	304 S/S	\$76.90	
RTBM408-Z	8mm	T20	8mm	3.25mm	Zinc Plated	\$40.00	○
RTBM410	10mm	T20	7.4mm	2.1mm	304 S/S	\$78.10	
RTBM410-Z	10mm	T20	8mm	3.25mm	Zinc Plated	\$46.80	○
RTBM412	12mm	T20	7.4mm	2.1mm	304 S/S	\$79.60	
RTBM412-Z	12mm	T20	8mm	3.25mm	Zinc Plated	\$48.00	○
RTBM416	16mm	T20	7.4mm	2.1mm	304 S/S	\$82.60	
RTBM416-Z	16mm	T20	8mm	3.25mm	Zinc Plated	\$49.50	○
RTBM420	20mm	T20	7.4mm	2.1mm	304 S/S	\$88.20	
RTBM420-Z	20mm	T20	8mm	3.25mm	Zinc Plated	\$38.80	○
RTBM425	25mm	T20	7.4mm	2.1mm	304 S/S	\$95.10	
RTBM430	30mm	T20	7.4mm	2.1mm	304 S/S	\$100.00	
RTBM430-Z	30mm	T20	8mm	3.25mm	Zinc Plated	\$42.50	○
RTBM440	40mm	T20	7.4mm	2.1mm	304 S/S	\$127.00	
RTBM450	50mm	T20	7.4mm	2.1mm	304 S/S	\$148.00	

We can supply broken packs; just add 20% to the price.

RESYTORK BUTTON HEAD MACHINE SCREWS

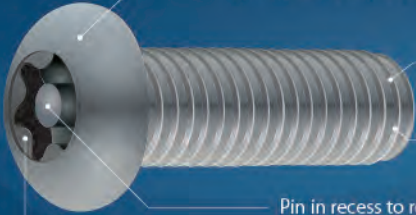

Domed button head shape has excellent visual effect and safety benefits. Other special head shapes can be custom manufactured to suit specific projects.

Precision manufactured in 304 Stainless steel, 316 Stainless steel, Zinc and Galvanised versions can be produced on request.

Imperial threads available see page 13

Pin in recess to resist tampering.

6 Lobe high torque drive with chamfer to assist driver tool insertion.

LEVEL 1:
Basic Security



Can be installed and removed with the following tools:



Insert Bit



Key Wrench



Screwdriver

See page 134 - For more details on Driver Tools



○ = Zinc Plated

PART NO.	LENGTH 	DRIVE SIZE 	HEAD DIA 	HEAD HEIGHT 	MATERIAL 	\$/100 
RTBM508	8mm	T25	9.3mm	2.6mm	304 S/S	\$99.00
RTBM508-Z	8mm	T25	10mm	3.95mm	Zinc Plated	\$45.50 ○
RTBM510	10mm	T25	9.3mm	2.6mm	304 S/S	\$101.20
RTBM510-Z	10mm	T25	10mm	3.95mm	Zinc Plated	\$54.00 ○
RTBM512	12mm	T25	9.3mm	2.6mm	304 S/S	\$103.90
RTBM512-Z	12mm	T25	10mm	3.95mm	Zinc Plated	\$57.00 ○
RTBM516	16mm	T25	9.3mm	2.6mm	304 S/S	\$109.40
RTBM516-Z	16mm	T25	10mm	3.95mm	Zinc Plated	\$69.50 ○
RTBM518	18mm	T25	9.3mm	2.6mm	304 S/S	\$146.00
RTBM520	20mm	T25	9.3mm	2.6mm	304 S/S	\$116.70
RTBM520-Z	20mm	T25	10mm	3.95mm	Zinc Plated	\$55.00 ○
RTBM525	25mm	T25	9.3mm	2.6mm	304 S/S	\$131.60
RTBM525-Z	25mm	T25	10mm	3.95mm	Zinc Plated	\$62.80 ○
RTBM530	30mm	T25	9.3mm	2.6mm	304 S/S	\$139.80
RTBM530-Z	30mm	T25	10mm	3.95mm	Zinc Plated	\$64.00 ○
RTBM535	35mm	T25	9.3mm	2.6mm	304 S/S	\$149.60
RTBM540	40mm	T25	9.3mm	2.6mm	304 S/S	\$164.40
RTBM550	50mm	T25	9.3mm	2.6mm	304 S/S	\$183.90



RESYTORK BUTTON HEAD MACHINE SCREWS

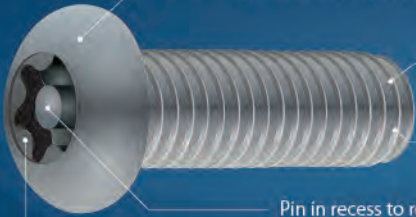

Domed button head shape has excellent visual effect and safety benefits. Other special head shapes can be custom manufactured to suit specific projects.

Precision manufactured in 304 Stainless steel, 316 Stainless steel, Zinc and Galvanised versions can be produced on request.

Imperial threads available see page 13

Pin in recess to resist tampering.

6 Lobe high torque drive with chamfer to assist driver tool insertion.

LEVEL 1:
Basic Security

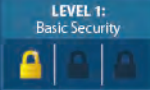

Can be installed and removed with the following tools:



Insert Bit



Key Wrench



Screwdriver

See page 134 - For more details on Driver Tools



○ = Zinc Plated

PART NO.	LENGTH	DRIVE SIZE	HEAD DIA	HEAD HEIGHT	MATERIAL	\$/100	
RTBM608	8mm	T30	10.3mm	3.2mm	304 S/S	\$104.80	
RTBM610	10mm	T30	10.3mm	3.2mm	304 S/S	\$105.30	
RTBM610-Z	10mm	T30	12mm	4.75mm	Zinc Plated	\$65.25	○
RTBM612	12mm	T30	10.3mm	3.2mm	304 S/S	\$105.80	
RTBM612-Z	12mm	T30	12mm	4.75mm	Zinc Plated	\$74.80	○
RTBM616	16mm	T30	10.3mm	3.2mm	304 S/S	\$107.30	
RTBM616-Z	16mm	T30	12mm	4.75mm	Zinc Plated	\$78.20	○
RTBM620	20mm	T30	10.3mm	3.2mm	304 S/S	\$115.80	
RTBM620-Z	20mm	T30	12mm	4.75mm	Zinc Plated	\$79.25	○
RTBM625	25mm	T30	10.3mm	3.2mm	304 S/S	\$132.90	
RTBM630	30mm	T30	10.3mm	3.2mm	304 S/S	\$141.80	
RTBM635	35mm	T30	10.3mm	3.2mm	304 S/S	\$158.00	
RTBM640	40mm	T30	10.3mm	3.2mm	304 S/S	\$164.80	
RTBM650	50mm	T30	10.3mm	3.2mm	304 S/S	\$183.50	
RTBM660	60mm	T30	10.3mm	3.2mm	304 S/S	\$215.00	
RTBM670	70mm	T30	10.3mm	3.2mm	304 S/S	\$245.00	
RTBM675	75mm	T30	10.3mm	3.2mm	304 S/S	\$315.00	
RTBM680	80mm	T30	10.3mm	3.2mm	304 S/S	\$330.00	

We can supply broken packs; just add 20% to the price.

RESYTORK BUTTON HEAD MACHINE SCREWS

Domed button head shape has excellent visual effect and safety benefits. Other special head shapes can be custom manufactured to suit specific projects.

Precision manufactured in 304 Stainless steel, 316 Stainless steel, Zinc and Galvanised versions can be produced on request.

Imperial threads available see page 13

Pin in recess to resist tampering.

6 Lobe high torque drive with chamfer to assist driver tool insertion.

LEVEL 1:
Basic Security

Can be installed and removed with the following tools:

- Insert Bit
- Key Wrench
- Screwdriver

See page 134 - For more details on Driver Tools



● = 316 S/S

PART NO.	LENGTH	DRIVE SIZE	HEAD DIA	HEAD HEIGHT	MATERIAL	\$/100
RTBM810	10mm	T40	13.7mm	4.5mm	304 S/S	\$220.00
RTBM812	12mm	T40	13.7mm	4.5mm	304 S/S	\$232.00
RTBM816	16mm	T40	13.7mm	4.5mm	304 S/S	\$246.50
RTBM820	20mm	T40	13.7mm	4.5mm	304 S/S	\$275.00
RTBM825	25mm	T40	13.7mm	4.5mm	304 S/S	\$299.00
RTBM830	30mm	T40	13.7mm	4.5mm	304 S/S	\$328.30
RTBM830-A4	30mm	T40	13.7mm	4.5mm	316 S/S	\$495.00 ●
RTBM835	35mm	T40	13.7mm	4.5mm	304 S/S	\$352.00
RTBM840	40mm	T40	13.7mm	4.5mm	304 S/S	\$370.00
RTBM850	50mm	T40	13.7mm	4.5mm	304 S/S	\$404.00
RTBM855	55mm	T40	13.7mm	4.5mm	304 S/S	\$418.00
RTBM860	60mm	T40	13.7mm	4.5mm	304 S/S	\$438.50
RTBM865	65mm	T40	13.7mm	4.5mm	304 S/S	\$460.00
RTBM870	70mm	T40	13.7mm	4.5mm	304 S/S	\$490.00
RTBM875	75mm	T40	13.7mm	4.5mm	304 S/S	\$506.00
RTBM880	80mm	T40	13.7mm	4.5mm	304 S/S	\$523.00
RTBM890-A4	90mm	T40	13.7mm	4.5mm	316 S/S	\$545.00 ●
RTBM895	95mm	T40	13.7mm	4.5mm	304 S/S	\$545.00
RTBM8100	100mm	T40	13.7mm	4.5mm	304 S/S	\$569.00

RESYTORK BUTTON HEAD MACHINE SCREWS

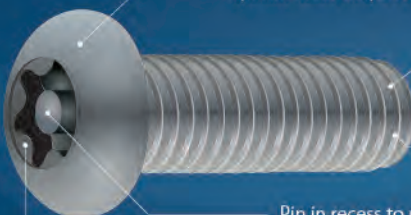

Domed button head shape has excellent visual effect and safety benefits. Other special head shapes can be custom manufactured to suit specific projects.

Precision manufactured in 304 Stainless steel, 316 Stainless steel, Zinc and Galvanised versions can be produced on request.

Imperial threads available see page 13



Pin in recess to resist tampering.

6 Lobe high torque drive with chamfer to assist driver tool insertion.

LEVEL 1:
Basic Security



Can be installed and removed with the following tools:

-  Insert Bit
-  Key Wrench
-  Screwdriver

See page 134 - For more details on Driver Tools

M10



PART NO.	LENGTH	DRIVE SIZE	HEAD DIA	HEAD HEIGHT	MATERIAL	\$/100
RTBM1016	16mm	T45	17.3mm	5.5mm	304 S/S	\$352.00
RTBM1020	20mm	T45	17.3mm	5.5mm	304 S/S	\$359.00
RTBM1025	25mm	T45	17.3mm	5.5mm	304 S/S	\$382.00
RTBM1030	30mm	T45	17.3mm	5.5mm	304 S/S	\$431.00
RTBM1035	35mm	T45	17.3mm	5.5mm	304 S/S	\$447.00
RTBM1040	40mm	T45	17.3mm	5.5mm	304 S/S	\$462.00
RTBM1045	45mm	T45	17.3mm	5.5mm	304 S/S	\$484.00
RTBM1050	50mm	T45	17.3mm	5.5mm	304 S/S	\$502.00
RTBM1060	60mm	T45	17.3mm	5.5mm	304 S/S	\$537.00
RTBM1065	65mm	T45	17.3mm	5.5mm	304 S/S	\$564.90
RTBM1070	70mm	T45	17.3mm	5.5mm	304 S/S	\$607.00
RTBM1080	80mm	T45	17.3mm	5.5mm	304 S/S	\$692.00
RTBM1090	90mm	T45	17.3mm	5.5mm	304 S/S	\$732.00

M12



PART NO.	LENGTH	DRIVE SIZE	HEAD DIA	HEAD HEIGHT	MATERIAL	\$/100
RTBM1230	30mm	T50	20.5mm	6.7mm	304 S/S	\$1,120.00

Other M12 sizes can be made to order

RESYTORK BUTTON HEAD MACHINE SCREWS

Domed button head shape has excellent visual effect and safety benefits. Other special head shapes can be custom manufactured to suit specific projects.

Precision manufactured in 304 Stainless steel, 316 Stainless steel, Zinc and Galvanised versions can be produced on request.

Metric threads available see pages 8-12

Pin in recess to resist tampering.

6 Lobe high torque drive with chamfer to assist driver tool insertion.

LEVEL 1:
Basic Security

Can be installed and removed with the following tools:

- Insert Bit
- Key Wrench
- Screwdriver

See page 134 - For more details on Driver Tools

6-32 UNC

PART NO.	LENGTH	DRIVE SIZE	HEAD DIA	HEAD HEIGHT	MATERIAL	\$/100
RTBM632C	3/8" (9.5mm)	T10	6.5mm	2.2mm	304 S/S	\$104.00
RTBM632D	1/2" (13mm)	T10	6.5mm	2.2mm	304 S/S	\$106.00
RTBM632F	3/4" (19mm)	T10	6.5mm	2.2mm	304 S/S	\$120.00
RTBM632G	1" (25mm)	T10	6.5mm	2.2mm	304 S/S	\$134.00
RTBM632I	1 1/2" (38mm)	T10	6.5mm	2.2mm	304 S/S	\$138.00
RTBM632J	2" (50mm)	T10	6.5mm	2.2mm	304 S/S	\$225.00

8-32 UNC

PART NO.	LENGTH	DRIVE SIZE	HEAD DIA	HEAD HEIGHT	MATERIAL	\$/100
RTBM832C	3/8" (9.5mm)	T15	7.5mm	2.2mm	304 S/S	\$108.00
RTBM832D	1/2" (13mm)	T15	7.5mm	2.2mm	304 S/S	\$112.00
RTBM832E	5/8" (16mm)	T15	7.5mm	2.2mm	304 S/S	\$115.00
RTBM832F	3/4" (19mm)	T15	7.5mm	2.2mm	304 S/S	\$119.00
RTBM832G	1" (25mm)	T15	7.5mm	2.2mm	304 S/S	\$126.00
RTBM832H	1 1/4" (32mm)	T15	7.5mm	2.2mm	304 S/S	\$138.00
RTBM832I	1 1/2" (38mm)	T15	7.5mm	2.2mm	304 S/S	\$146.00

We can supply broken packs; just add 20% to the price.

10-24 UNC

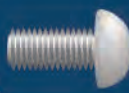

PART NO.	LENGTH 	DRIVE SIZE 	HEAD DIA 	HEAD HEIGHT 	MATERIAL 	\$/100
RTBM1024C	3/8" (9.5mm)	T25	9.0mm	2.5mm	304 S/S	\$128.00
RTBM1024D	1/2" (13mm)	T25	9.0mm	2.5mm	304 S/S	\$136.00
RTBM1024F	3/4" (19mm)	T25	9.0mm	2.5mm	304 S/S	\$152.00
RTBM1024G	1" (25mm)	T25	9.0mm	2.5mm	304 S/S	\$156.00
RTBM1024H	1 1/4" (32mm)	T25	9.0mm	2.5mm	304 S/S	\$172.00
RTBM1024I	1 1/2" (38mm)	T25	9.0mm	2.5mm	304 S/S	\$189.00
RTBM1024J	2" (50mm)	T25	9.0mm	2.5mm	304 S/S	\$252.00

10-32 UNF

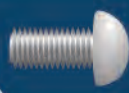

PART NO.	LENGTH 	DRIVE SIZE 	HEAD DIA 	HEAD HEIGHT 	MATERIAL 	\$/100
RTBM1032C	3/8" (9.5mm)	T25	9.0mm	2.5mm	304 S/S	\$128.00
RTBM1032D	1/2" (13mm)	T25	9.0mm	2.5mm	304 S/S	\$136.00
RTBM1032F	3/4" (19mm)	T25	9.0mm	2.5mm	304 S/S	\$152.00
RTBM1032G	1" (25mm)	T25	9.0mm	2.5mm	304 S/S	\$156.00
RTBM1032H	1 1/4" (32mm)	T25	9.0mm	2.5mm	304 S/S	\$172.00
RTBM1032I	1 1/2" (38mm)	T25	9.0mm	2.5mm	304 S/S	\$189.00

1/4-20 UNC

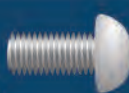

PART NO.	LENGTH 	DRIVE SIZE 	HEAD DIA 	HEAD HEIGHT 	MATERIAL 	\$/100
RTBM1/4C	3/8" (9.5mm)	T27	11mm	3.2mm	304 S/S	\$206.00
RTBM1/4D	1/2" (13mm)	T27	11mm	3.2mm	304 S/S	\$190.00
RTBM1/4E	5/8" (16mm)	T27	11mm	3.2mm	304 S/S	\$196.00
RTBM1/4F	3/4" (19mm)	T27	11mm	3.2mm	304 S/S	\$212.00
RTBM1/4G	1" (25mm)	T27	11mm	3.2mm	304 S/S	\$236.00
RTBM1/4H	1 1/4" (32mm)	T27	11mm	3.2mm	304 S/S	\$248.00
RTBM1/4I	1 1/2" (38mm)	T27	11mm	3.2mm	304 S/S	\$252.00
RTBM1/4J	2" (50mm)	T27	11mm	3.2mm	304 S/S	\$255.00

RESYTORK BUTTON HEAD MACHINE SCREWS

Domed button head shape has excellent visual effect and safety benefits. Other special head shapes can be custom manufactured to suit specific projects.

Precision manufactured in 304 Stainless steel, 316 Stainless steel, Zinc and Galvanised versions can be produced on request.

Metric threads available see pages 8-12

Pin in recess to resist tampering.

6 Lobe high torque drive with chamfer to assist driver tool insertion.

LEVEL 1:
Basic Security

Can be installed and removed with the following tools:

- Insert Bit
- Key Wrench
- Screwdriver

See page 134 - For more details on Driver Tools

5/16 UNC

PART NO.	LENGTH	DRIVE SIZE	HEAD DIA	HEAD HEIGHT	MATERIAL	\$/100
RTBM5/16D	1/2" (13mm)	T40	13.5mm	4.0mm	304 S/S	\$248.00
RTBM5/16E	5/8" (16mm)	T40	13.5mm	4.0mm	304 S/S	\$260.00
RTBM5/16F	3/4" (19mm)	T40	13.5mm	4.0mm	304 S/S	\$292.00
RTBM5/16G	1" (25mm)	T40	13.5mm	4.0mm	304 S/S	\$325.00
RTBM5/16H	1 1/4" (32mm)	T40	13.5mm	4.0mm	304 S/S	\$348.00
RTBM5/16I	1 1/2" (38mm)	T40	13.5mm	4.0mm	304 S/S	\$385.00
RTBM5/16J	2" (50mm)	T40	13.5mm	4.0mm	304 S/S	\$415.00

3/8 UNC

PART NO.	LENGTH	DRIVE SIZE	HEAD DIA	HEAD HEIGHT	MATERIAL	\$/100
RTBM3/8E	5/8" (16mm)	T45	16.5mm	4.75mm	304 S/S	\$352.00
RTBM3/8F	3/4" (19mm)	T45	16.5mm	4.75mm	304 S/S	\$359.00
RTBM3/8G	1" (25mm)	T45	16.5mm	4.75mm	304 S/S	\$382.00
RTBM3/8H	1 1/4" (32mm)	T45	16.5mm	4.75mm	304 S/S	\$431.00
RTBM3/8I	1 1/2" (38mm)	T45	16.5mm	4.75mm	304 S/S	\$462.00
RTBM3/8J	2" (50mm)	T45	16.5mm	4.75mm	304 S/S	\$502.00
RTBM3/8L	3" (75mm)	T45	16.5mm	4.75mm	304 S/S	\$552.00
RTBM3/8N	4" (100mm)	T45	16.5mm	4.75mm	304 S/S	\$1,092.00

RESYTORK GRUB SCREWS



Only security grub screw in stock in Australia!

Stocked in 304 Stainless steel.

Other sizes can be made to order, MOQ500pce

LEVEL 1:
Basic Security







Can be installed and removed with the following tools:



Insert Bit



Key Wrench



Screwdriver

See page 134 - For more details on Driver Tools

M5



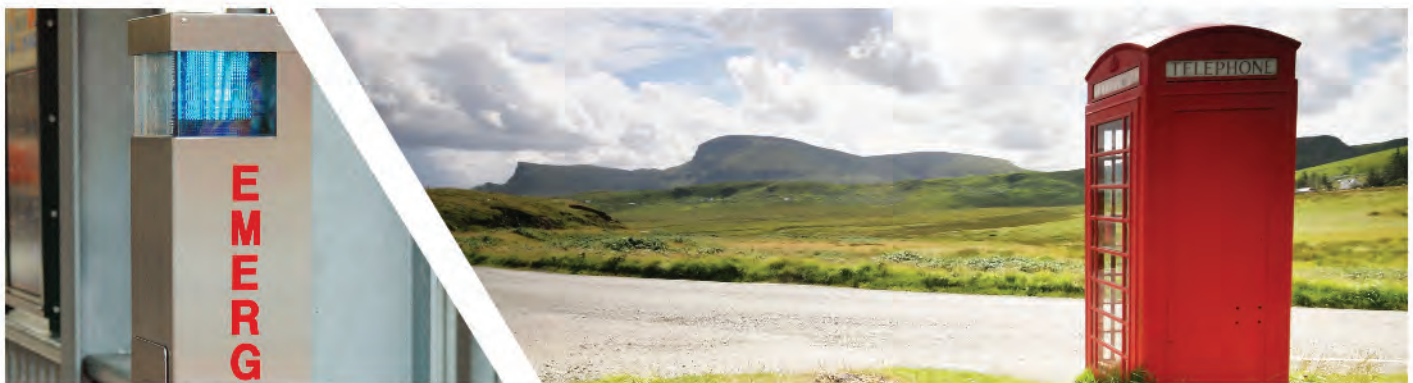

PART NO.	LENGTH	DRIVE SIZE	MATERIAL	\$/ea	\$/100
RTGS508	8mm	T10	304 S/S	\$9.88	\$790.00
RTGS510	10mm	T10	304 S/S	\$10.12	\$810.00
RTGS512	12mm	T10	304 S/S	\$10.38	\$830.00
RTGS516	16mm	T10	304 S/S	\$10.63	\$850.00

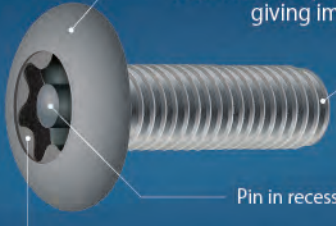

TRUSS HEAD OPTION

AVAILABLE FOR SPECIAL ORDER
Contact our sales team to find out more





Truss Head shape is larger and flatter than traditional Button head, giving improved appearance and holding power.

Available in Zinc plated steel. Stainless steel also available by special request.

Pin in recess to resist tampering.

6 Lobe high torque drive with chamfer to assist driver tool insertion.

LEVEL 1:
Basic Security

RESYTORK COUNTERSUNK SELF TAPPING SCREWS

Countersunk head seats flush with material.

Sharp self-tapping thread for screwing into pre-drilled holes. Taper point for accurate locating.

Stocked in 304 Stainless steel. 316 Stainless steel, Zinc and Galvanised versions can be made to order.

Pin in recess to resist tampering.

6 Lobe high torque drive with chamfer to assist driver tool insertion.

LEVEL 1:
Basic Security

Can be installed and removed with the following tools:

- Insert Bit
- Key Wrench
- Screwdriver

See page 134 - For more details on Driver Tools

4G

PART NO.	LENGTH	DRIVE SIZE	HEAD DIA	HEAD HEIGHT	MATERIAL	\$/100
RTCS4D	1/2" (13mm)	T10	4.8mm	1.8mm	304 S/S	\$73.00
RTCS4F	3/4" (19mm)	T10	4.8mm	1.8mm	304 S/S	\$76.00

6G

PART NO.	LENGTH	DRIVE SIZE	HEAD DIA	HEAD HEIGHT	MATERIAL	\$/100
RTCS6C	3/8" (9.5mm)	T15	6.6mm	2.1mm	304 S/S	\$82.20
RTCS6D	1/2" (13mm)	T15	6.6mm	2.1mm	304 S/S	\$83.80
RTCS6E	5/8" (16mm)	T15	6.6mm	2.1mm	304 S/S	\$86.60
RTCS6F	3/4" (19mm)	T15	6.6mm	2.1mm	304 S/S	\$89.90
RTCS6G	1" (25mm)	T15	6.6mm	2.1mm	304 S/S	\$95.80
RTCS6H	1 1/4" (32mm)	T15	6.6mm	2.1mm	305 S/S	\$109.80
RTCS6I	1 1/2" (38mm)	T15	6.6mm	2.1mm	304 S/S	\$125.10
RTCS6J	2" (50mm)	T15	6.6mm	2.1mm	304 S/S	\$162.50
RTCS6K	2 1/2" (63mm)	T15	6.6mm	2.1mm	304 S/S	\$328.00



RESYTORK COUNTERSUNK SELF TAPPING SCREWS

Countersunk head seats flush with material.

Sharp self-tapping thread for screwing into pre-drilled holes. Taper point for accurate locating.

Stocked in 304 Stainless steel. 316 Stainless steel, Zinc and Galvanised versions can be made to order.

Pin in recess to resist tampering.

6 Lobe high torque drive with chamfer to assist driver tool insertion.

LEVEL 1:
Basic Security

Can be installed and removed with the following tools:

- Insert Bit
- Key Wrench
- Screwdriver

See page 134 - For more details on Driver Tools



PART NO.	LENGTH	DRIVE SIZE	HEAD DIA	HEAD HEIGHT	MATERIAL	\$/100
RTCS8D	1/2" (13mm)	T20	7.9mm	2.5mm	304 S/S	\$93.00
RTCS8E	5/8" (16mm)	T20	7.9mm	2.5mm	304 S/S	\$96.00
RTCS8F	3/4" (19mm)	T20	7.9mm	2.5mm	304 S/S	\$98.80
RTCS8G	1" (25mm)	T20	7.9mm	2.5mm	304 S/S	\$111.80
RTCS8H	1 1/4" (32mm)	T20	7.9mm	2.5mm	304 S/S	\$118.60
RTCS8I	1 1/2" (38mm)	T20	7.9mm	2.5mm	304 S/S	\$142.60
RTCS8J	2" (50mm)	T20	7.9mm	2.5mm	304 S/S	\$158.70
RTCS8K	2 1/2" (63mm)	T20	7.9mm	2.5mm	304 S/S	\$165.00



PART NO.	LENGTH	DRIVE SIZE	HEAD DIA	HEAD HEIGHT	MATERIAL	\$/100
RTCS10D	1/2" (13mm)	T25	9.3mm	3mm	304 S/S	\$108.70
RTCS10E	5/8" (16mm)	T25	9.3mm	3mm	304 S/S	\$118.60
RTCS10F	3/4" (19mm)	T25	9.3mm	3mm	304 S/S	\$125.10
RTCS10G	1" (25mm)	T25	9.3mm	3mm	304 S/S	\$133.40
RTCS10H	1 1/4" (32mm)	T25	9.3mm	3mm	304 S/S	\$145.00
RTCS10I	1 1/2" (38mm)	T25	9.3mm	3mm	304 S/S	\$169.90
RTCS10J	2" (50mm)	T25	9.3mm	3mm	304 S/S	\$191.80
RTCS10K	2 1/2" (63mm)	T25	9.3mm	3mm	304 S/S	\$229.50
RTCS10L	3" (75mm)	T25	9.3mm	3mm	304 S/S	\$267.00
RTCS10N	4" (100mm)	T25	9.3mm	3mm	304 S/S	\$304.50

RESYTORK COUNTERSUNK SELF TAPPING SCREWS

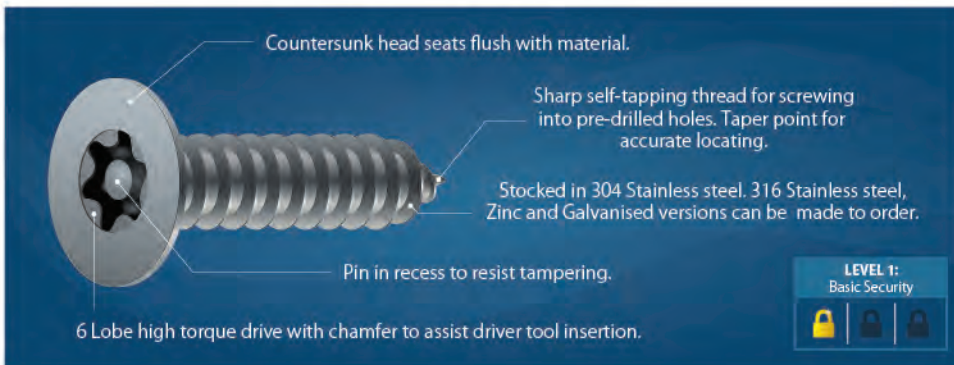

LEVEL 1:
Basic Security

Can be installed and removed with the following tools:

- Insert Bit
- Key Wrench
- Screwdriver

See page 134 - For more details on Driver Tools



● = 316 S/S

PART NO.	LENGTH	DRIVE SIZE	HEAD DIA	HEAD HEIGHT	MATERIAL	\$/100
RTCS12E	5/8" (16mm)	T30	10mm	4.0mm	304 S/S	\$198.00
RTCS12F	3/4" (19mm)	T30	10mm	4.0mm	304 S/S	\$203.00
RTCS12G	1" (25mm)	T27	10mm	4.0mm	304 S/S	\$207.90
RTCS12H	1 1/4" (32mm)	T27	10mm	4.0mm	304 S/S	\$211.50
RTCS12H-A4	1 1/4" (32mm)	T27	10mm	4.0mm	316 S/S	\$450.00 ●
RTCS12I	1 1/2" (38mm)	T27	10mm	4.0mm	304 S/S	\$243.20
RTCS12J	2" (50mm)	T27	10mm	4.0mm	304 S/S	\$260.20
RTCS12K	2 1/2" (63mm)	T27	10mm	4.0mm	304 S/S	\$301.50
RTCS12L	3" (75mm)	T27	10mm	4.0mm	304 S/S	\$310.30



We can supply broken packs; just add 20% to the price.

PART NO.	LENGTH	DRIVE SIZE	HEAD DIA	HEAD HEIGHT	MATERIAL	\$/100
RTCS14E	5/8" (16mm)	T30	12.8mm	4.8mm	304 S/S	\$180.30
RTCS14F	3/4" (19mm)	T30	12.8mm	4.8mm	304 S/S	\$184.00
RTCS14G	1" (25mm)	T30	12.8mm	4.8mm	304 S/S	\$194.20
RTCS14H	1 1/4" (32mm)	T30	12.8mm	4.8mm	304 S/S	\$268.40
RTCS14I	1 1/2" (38mm)	T30	12.8mm	4.8mm	304 S/S	\$309.10
RTCS14J	2" (50mm)	T30	12.8mm	4.8mm	304 S/S	\$475.00

RESYTORK BUTTON HEAD SELF TAPPING SCREWS

Domed button head shape has excellent visual effect and safety benefits.

Sharp self-tapping thread for screwing into pre-drilled holes. Taper point for accurate locating.

Stocked in 304 Stainless steel. 316 Stainless steel, Zinc and Galvanised versions can be made to order.

Pin in recess to resist tampering.

6 Lobe high torque drive with chamfer to assist driver tool insertion.

LEVEL 1:
Basic Security

Can be installed and removed with the following tools:

- Insert Bit
- Key Wrench
- Screwdriver

See page 134 - For more details on Driver Tools



● = 316 S/S

PART NO.	LENGTH	DRIVE SIZE	HEAD DIA	HEAD HEIGHT	MATERIAL	\$/100
RTBS6C	3/8" (9.5mm)	T10	6.7mm	2.5mm	304 S/S	\$81.30
RTBS6D	1/2" (13mm)	T10	6.7mm	2.5mm	304 S/S	\$83.80
RTBS6E	5/8" (16mm)	T10	6.7mm	2.5mm	304 S/S	\$87.30
RTBS6F	3/4" (19mm)	T10	6.7mm	2.5mm	304 S/S	\$89.90
RTBS6G	1" (25mm)	T10	6.7mm	2.5mm	304 S/S	\$95.80
RTBS6I	1 1/2" (38mm)	T10	6.7mm	2.5mm	304 S/S	\$125.10
RTBS6K	2 1/2" (63mm)	T10	6.7mm	2.5mm	304 S/S	\$328.00



PART NO.	LENGTH	DRIVE SIZE	HEAD DIA	HEAD HEIGHT	MATERIAL	\$/100
RTBS8C	3/8" (9.5mm)	T15	7.4mm	2.1mm	304 S/S	\$89.60
RTBS8D	1/2" (13mm)	T15	7.4mm	2.1mm	304 S/S	\$93.00
RTBS8E	5/8" (16mm)	T15	7.4mm	2.1mm	304 S/S	\$96.00
RTBS8F	3/4" (19mm)	T15	7.4mm	2.1mm	304 S/S	\$98.80
RTBS8G	1" (25mm)	T15	7.4mm	2.1mm	304 S/S	\$111.80
RTBS8H	1 1/4" (32mm)	T15	7.4mm	2.1mm	304 S/S	\$118.60
RTBS8I	1 1/2" (38mm)	T15	7.4mm	2.1mm	304 S/S	\$142.60
RTBS8I-A4	1 1/2" (38mm)	T15	7.4mm	2.1mm	316 S/S	\$435.00
RTBS8J	2" (50mm)	T15	7.4mm	2.1mm	304 S/S	\$158.70

RESYTORK BUTTON HEAD SELF TAPPING SCREWS

Domed button head shape has excellent visual effect and safety benefits.

Sharp self-tapping thread for screwing into pre-drilled holes. Taper point for accurate locating.

Stocked in 304 Stainless steel. 316 Stainless steel, Zinc and Galvanised versions can be made to order.

Pin in recess to resist tampering.

6 Lobe high torque drive with chamfer to assist driver tool insertion.

LEVEL 1:
Basic Security

Can be installed and removed with the following tools:

Insert Bit

Key Wrench

Screwdriver

See page 134 - For more details on Driver Tools



○ = Zinc Plated

PART NO.	LENGTH	DRIVE SIZE	HEAD DIA	HEAD HEIGHT	MATERIAL	\$/100
RTBS10C	3/8" (9.5mm)	T25	9.3mm	2.6mm	304 S/S	\$139.00
RTBS10D	1/2" (13mm)	T25	9.3mm	2.6mm	304 S/S	\$108.70
RTBS10E	5/8" (16mm)	T25	9.3mm	2.6mm	304 S/S	\$122.50
RTBS10F	3/4" (19mm)	T25	9.3mm	2.6mm	304 S/S	\$125.10
RTBS10G	1" (25mm)	T25	9.3mm	2.6mm	304 S/S	\$133.40
RTBS10H	1 1/4" (32mm)	T25	9.3mm	2.6mm	304 S/S	\$145.00
RTBS10I	1 1/2" (38mm)	T25	9.3mm	2.6mm	304 S/S	\$169.90
RTBS10I75	1 3/4" (45mm)	T25	9.3mm	2.6mm	304 S/S	\$289.00
RTBS10J	2" (50mm)	T25	9.3mm	2.6mm	304 S/S	\$191.80



We can supply broken packs; just add 20% to the price.

PART NO.	LENGTH	DRIVE SIZE	HEAD DIA	HEAD HEIGHT	MATERIAL	\$/100
RTBS12E	5/8" (16mm)	T27	10mm	3.1mm	304 S/S	\$198.80
RTBS12F	3/4" (19mm)	T27	10mm	3.1mm	304 S/S	\$205.00
RTBS12G	1" (25mm)	T27	10mm	3.1mm	304 S/S	\$207.90
RTBS12H	1 1/4" (32mm)	T27	10mm	3.1mm	304 S/S	\$211.50
RTBS12I	1 1/2" (38mm)	T27	10mm	3.1mm	304 S/S	\$243.20
RTBS12J	2" (50mm)	T27	10mm	3.1mm	304 S/S	\$260.20
RTBS12K	2 1/2" (63mm)	T27	10mm	3.1mm	304 S/S	\$301.50
RTBS12K-Z	2 1/2" (63mm)	T25	9.2mm	3.0mm	Zinc	\$176.00
RTBS12L	3" (75mm)	T27	10mm	3.1mm	304 S/S	\$310.30

RESYTORK BUTTON HEAD SELF TAPPING SCREWS

Domed button head shape has excellent visual effect and safety benefits.

Sharp self-tapping thread for screwing into pre-drilled holes. Taper point for accurate locating.

Stocked in 304 Stainless steel. 316 Stainless steel, Zinc and Galvanised versions can be made to order.

Pin in recess to resist tampering.

6 Lobe high torque drive with chamfer to assist driver tool insertion.

LEVEL 1:
Basic Security

Can be installed and removed with the following tools:

- Insert Bit
- Key Wrench
- Screwdriver

See page 134 - For more details on Driver Tools



● = 316 S/S
○ = Zinc Plated

PART NO.	LENGTH	DRIVE SIZE	HEAD DIA	HEAD HEIGHT	MATERIAL	\$/100
RTBS14E	5/8" (16mm)	T27	11mm	3.4mm	304 S/S	\$233.30
RTBS14F	3/4" (19mm)	T30	11mm	3.4mm	304 S/S	\$238.00
RTBS14G	1" (25mm)	T30	11mm	3.4mm	304 S/S	\$259.00
RTBS14H	1 1/4" (32mm)	T30	11mm	3.4mm	304 S/S	\$268.40
RTBS14I	1 1/2" (38mm)	T30	11mm	3.4mm	304 S/S	\$309.10
RTBS14I-A4	1 1/2" (38mm)	T27	11mm	3.4mm	316 S/S	\$480.00
RTBS14J	2" (50mm)	T30	11mm	3.4mm	304 S/S	\$475.00
RTBS14L	3" (75mm)	T30	11mm	3.4mm	304 S/S	\$550.00



PART NO.	LENGTH	DRIVE SIZE	HEAD DIA	HEAD HEIGHT	MATERIAL	\$/100
RTBS18K-Z	2 1/2" (63mm)	T45	15.6mm	4.8mm	Zinc	\$385.00



RESYTORK PAN HEAD SELF DRILLING SCREWS

Domed pan head shape has excellent visual effect and safety benefits. Other special head shapes can be custom manufactured to suit specific projects.

Sharp self-drilling tip for accurate locating and effective pre-drilling maximizes work efficiency and reduces down time.

Sharp self-tapping thread precision manufactured in 410 Stainless steel and galvanised plated version.

Pin in recess to resist tampering.

6 Lobe high torque drive with chamfer to assist driver tool insertion.

LEVEL 1:
Basic Security

Can be installed and removed with the following tools:

- Insert Bit
- Key Wrench
- Screwdriver

See page 134 - For more details on Driver Tools



PART NO.	LENGTH	DRIVE SIZE	HEAD DIA	HEAD HEIGHT	MATERIAL	\$/100
RTPSD6C	3/8" (9.5mm)	T15	6.7mm	2.3mm	410 S/S	\$109.38
RTPSD6D	1/2" (13mm)	T15	6.7mm	2.3mm	410 S/S	\$114.84



● = Galvanised

PART NO.	LENGTH	DRIVE SIZE	HEAD DIA	HEAD HEIGHT	MATERIAL	\$/100
RTPSD8D	1/2" (13mm)	T20	8mm	2.9mm	410 S/S	\$128.00
RTPSD8D-G	1/2" (13mm)	T20	7.9mm	2.9mm	Galvanised	\$127.20
RTPSD8F	3/4" (19mm)	T20	8mm	2.9mm	410 S/S	\$130.00
RTPSD8G	1" (25mm)	T20	8mm	2.9mm	410 S/S	\$132.00
RTPSD8G-G	1" (25mm)	T20	7.9mm	2.9mm	Galvanised	\$136.80
RTPSD8H	1 1/4" (32mm)	T20	8mm	2.9mm	410 S/S	\$136.00
RTPSD8I	1 1/2" (38mm)	T20	8mm	2.9mm	410 S/S	\$169.00
RTPSD8I-G	1 1/2" (38mm)	T20	7.9mm	2.9mm	Galvanised	\$153.60

Warning: Please be aware 410 stainless is a martensitic stainless and contains high level of carbon in its chemical composition. This results in 410 Stainless having a corrosion rating similar to zinc plated fasteners. Not Recommended for use outdoors.

We can supply broken packs; just add 20% to the price.

RESYTORK PAN HEAD SELF DRILLING SCREWS

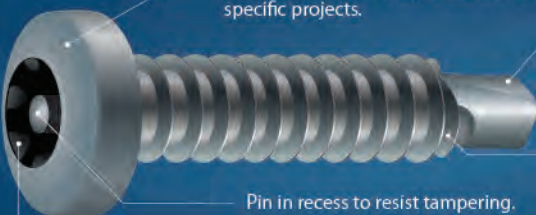

Domed pan head shape has excellent visual effect and safety benefits. Other special head shapes can be custom manufactured to suit specific projects.

Sharp self-drilling tip for accurate locating and effective pre-drilling maximizes work efficiency and reduces down time.

Sharp self-tapping thread precision manufactured in 410 Stainless steel and galvanised plated version.



Pin in recess to resist tampering.

6 Lobe high torque drive with chamfer to assist driver tool insertion.

LEVEL 1:
Basic Security



Can be installed and removed with the following tools:

-  Insert Bit
-  Key Wrench
-  Screwdriver

See page 134 - For more details on Driver Tools

10G



 = Galvanised

PART NO.	LENGTH	DRIVE SIZE	HEAD DIA	HEAD HEIGHT	MATERIAL	\$/100
RTPSD10D	1/2" (13mm)	T25	9mm	3.1mm	410 S/S	\$118.00
RTPSD10F	3/4" (19mm)	T25	9mm	3.1mm	410 S/S	\$122.00
RTPSD10F-G	3/4" (19mm)	T25	9.3mm	3.4mm	Galvanised	\$153.60
RTPSD10G	1" (25mm)	T25	9mm	3.1mm	410 S/S	\$118.00
RTPSD10G-G	1" (25mm)	T25	9.3mm	3.4mm	Galvanised	\$159.20
RTPSD10H	1 1/4" (32mm)	T25	9mm	3.1mm	410 S/S	\$150.00
RTPSD10I	1 1/2" (38mm)	T25	9mm	3.1mm	410 S/S	\$165.00
RTPSD10I-G	1 1/2" (38mm)	T25	9.3mm	3.4mm	Galvanised	\$181.00
RTPSD10J	2" (50mm)	T25	9mm	3.1mm	410 S/S	\$252.00
RTPSD10J-G	2" (50mm)	T25	9.3mm	3.4mm	Galvanised	\$196.80

12G



PART NO.	LENGTH	DRIVE SIZE	HEAD DIA	HEAD HEIGHT	MATERIAL	\$/100
RTPSD12F	3/4" (19mm)	T27	10.5mm	3.8mm	410 S/S	\$219.00
RTPSD12G	1" (25mm)	T27	10.5mm	3.8mm	410 S/S	\$245.00
RTPSD12G-G	1" (25mm)	T27	10.5mm	3.8mm	Galvanised	\$181.60
RTPSD12H	1 1/4" (32mm)	T27	10.5mm	3.8mm	410 S/S	\$275.00
RTPSD12I	1 1/2" (38mm)	T27	10.5mm	3.8mm	410 S/S	\$265.00
RTPSD12I-G	1 1/2" (38mm)	T27	10.5mm	3.8mm	Galvanised	\$198.40
RTPSD12J	2" (50mm)	T27	10.5mm	3.8mm	410 S/S	\$289.00
RTPSD12J-G	2" (50mm)	T27	10.5mm	3.8mm	Galvanised	\$220.80

Warning: Please be aware 410 stainless is a martensitic stainless and contains high level of carbon in its chemical composition. This results in 410 Stainless having a corrosion rating similar to zinc plated fasteners. Not Recommended for use outdoors.

RESYTORK PAN HEAD SELF DRILLING SCREWS

Domed pan head shape has excellent visual effect and safety benefits. Other special head shapes can be custom manufactured to suit specific projects.

Sharp self-drilling tip for accurate locating and effective pre-drilling maximizes work efficiency and reduces down time.

Sharp self-tapping thread precision manufactured in 410 Stainless steel and galvanised plated version.

Pin in recess to resist tampering.

6 Lobe high torque drive with chamfer to assist driver tool insertion.

LEVEL 1:
Basic Security

Can be installed and removed with the following tools:

- Insert Bit
- Key Wrench
- Screwdriver

See page 134 - For more details on Driver Tools



PART NO.	LENGTH	DRIVE SIZE	HEAD DIA	HEAD HEIGHT	MATERIAL	\$/100
RTPSD14F	3/4" (19mm)	T30	12mm	4mm	410 S/S	\$229.00
RTPSD14G	1" (25mm)	T30	12mm	4mm	410 S/S	\$239.00
RTPSD14H	1 1/4" (32mm)	T30	12mm	4mm	410 S/S	\$319.00
RTPSD14I	1 1/2" (38mm)	T30	12mm	4mm	410 S/S	\$302.00
RTPSD14J	2" (50mm)	T30	12mm	4mm	410 S/S	\$462.00



Warning: Please be aware 410 stainless is a martensitic stainless and contains high level of carbon in its chemical composition. This results in 410 Stainless having a corrosion rating similar to zinc plated fasteners. Not Recommended for use outdoors.

RESYTORK COUNTERSUNK SELF DRILLING SCREWS

Countersunk head seats flush with material. Other special head shapes can be custom manufactured to suits specific projects.

Sharp self-drilling tip for accurate locating and effective pre-drilling maximizes work efficiency and reduces down time.

Sharp self-drilling thread precision manufactured in galvanised and zinc plated version.

Pin in recess to resist tampering.

6 Lobe high torque drive with chamfer to assist driver tool insertion.

LEVEL 1:
Basic Security



Can be installed and removed with the following tools:

- Insert Bit
- Key Wrench
- Screwdriver

See page 134 - For more details on Driver Tools

8G



● = Galvanised
○ = Zinc Plated

PART NO.	LENGTH	DRIVE SIZE	HEAD DIA	HEAD HEIGHT	MATERIAL	\$/100
RTCSDB8D-G	1/2" (13mm)	T20	7.9mm	3.0mm	Galvanised	\$127.20 ●
RTCSDB8G-G	1" (25mm)	T20	7.9mm	3.0mm	Galvanised	\$136.80 ●

10G



PART NO.	LENGTH	DRIVE SIZE	HEAD DIA	HEAD HEIGHT	MATERIAL	\$/100
RTCSDB10D-Z	1/2" (13mm)	T20	8.9mm	Undercut	Zinc	\$98.75 ○
RTCSDB10F-Z	3/4" (19mm)	T20	8.9mm	2.9mm	Zinc	\$95.00 ○
RTCSDB10F-G	3/4" (19mm)	T25	9.3mm	3.2mm	Galvanised	\$153.60 ●
RTCSDB10G-G	1" (25mm)	T25	9.3mm	3.2mm	Galvanised	\$159.20 ●
RTCSDB10I-G	1 1/2" (38mm)	T25	9.3mm	3.2mm	Galvanised	\$181.60 ●
RTCSDB10J-G	2" (50mm)	T25	9.3mm	3.2mm	Galvanised	\$196.80 ●

12G



PART NO.	LENGTH	DRIVE SIZE	HEAD DIA	HEAD HEIGHT	MATERIAL	\$/100
RTCSDB12G-G	1" (25mm)	T27	10.6mm	3.7mm	Galvanised	\$181.60 ●
RTCSDB12I-G	1 1/2" (38mm)	T27	10.6mm	3.7mm	Galvanised	\$198.40 ●
RTCSDB12J-G	2" (50mm)	T27	10.6mm	3.7mm	Galvanised	\$220.80 ●

RESYTORK BUTTON HEAD TYPE 17 SCREWS

Domed button head shape has excellent visual effect and safety benefits. Other special head shapes can be custom manufactured to suit specific projects.

Sharp type 17 point for accurate locating and positive cutting thrust to eliminate splitting in timber.

Sharp self-tapping thread precision manufactured with durable yellow zinc or galvanised plating.

Pin in recess to resist tampering.

6 Lobe high torque drive with chamfer to assist driver tool insertion.

LEVEL 1:
Basic Security

Can be installed and removed with the following tools:

- Insert Bit
- Key Wrench
- Screwdriver

See page 134 - For more details on Driver Tools



PART NO.	LENGTH	DRIVE SIZE	HEAD DIA	HEAD HEIGHT	MATERIAL	\$/100
RTBT10F-Z	3/4" (19mm)	T25	9mm	3mm	Zinc	\$103.40
RTBT10F-G	3/4" (19mm)	T25	9mm	3mm	Galvanised	\$126.50
RTBT10G-Z	1" (25mm)	T25	9mm	3mm	Zinc	\$110.00
RTBT10G-G	1" (25mm)	T25	9mm	3mm	Galvanised	\$137.50
RTBT10G-A2	1" (25mm)	T25	9mm	3mm	304 S/S	\$680.00
RTBT10I-Z	1 1/2" (38mm)	T25	9mm	3mm	Zinc	\$137.50
RTBT10I-G	1 1/2" (38mm)	T25	9mm	3mm	Galvanised	\$165.00



RESYTORK COUNTERSUNK BARREL NUTS

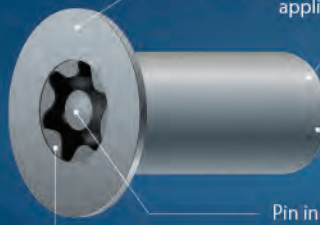

Countersunk head seats flush with material, for a neat, safe finish. Thread is inside the sleeve of the barrel nut, ideal for clamping applications where both sides are visible.

Stocked in 304 Stainless steel. Zinc and Galvanised versions can be produced on request.

Internally threaded with metric and imperial options.

Pin in recess to resist tampering.

6 Lobe high torque drive with chamfer to assist driver tool insertion.

LEVEL 1:
Basic Security

Can be installed and removed with the following tools:

- Insert Bit
- Key Wrench
- Screwdriver

See page 134 - For more details on Driver Tools

M4



PART NO.	LENGTH	DRIVE SIZE	HEAD DIA	HEAD HEIGHT	THREAD DEPTH	OUTSIDE DIA	MATERIAL	\$/100
RTCN0412	12mm	T20	7.8mm	2.3mm	6.5mm	5.3mm	304 S/S	\$168.00

M5



We can supply broken packs; just add 20% to the price.

PART NO.	LENGTH	DRIVE SIZE	HEAD DIA	HEAD HEIGHT	THREAD DEPTH	OUTSIDE DIA	MATERIAL	\$/100
RTCN0515	15mm	T25	9.8mm	2.8mm	8mm	6.3mm	304 S/S	\$225.00

M6



PART NO.	LENGTH	DRIVE SIZE	HEAD DIA	HEAD HEIGHT	THREAD DEPTH	OUTSIDE DIA	MATERIAL	\$/100
RTCN0620	20mm	T30	11.8mm	3.3mm	10mm	8mm	304 S/S	\$248.00

M8



PART NO.	LENGTH	DRIVE SIZE	HEAD DIA	HEAD HEIGHT	THREAD DEPTH	OUTSIDE DIA	MATERIAL	\$/100
RTCN0820	20mm	T40	14.8mm	4.4mm	12mm	10mm	304 S/S	\$310.00

RESYTORK COUNTERSUNK BARREL NUTS

Countersunk head seats flush with material, for a neat, safe finish. Thread is inside the sleeve of the barrel nut, ideal for clamping applications where both sides are visible.

Stocked in 304 Stainless steel. Zinc and Galvanised versions can be produced on request.

Internally threaded with metric and imperial options.

Pin in recess to resist tampering.

6 Lobe high torque drive with chamfer to assist driver tool insertion.

LEVEL 1:
Basic Security

Can be installed and removed with the following tools:

- Insert Bit
- Key Wrench
- Screwdriver

See page 134 - For more details on Driver Tools

M10

PART NO.	LENGTH	DRIVE SIZE	HEAD DIA	HEAD HEIGHT	THREAD DEPTH	OUTSIDE DIA	MATERIAL	\$/100
RTCN1027	27mm	T50	20mm	4.7mm	16.5mm	13.8mm	304 S/S	\$489.00

10-24 UNC

PART NO.	LENGTH	DRIVE SIZE	HEAD DIA	HEAD HEIGHT	THREAD DEPTH	OUTSIDE DIA	MATERIAL	\$/100
RTCN3/16S	22mm	T30	12.5mm	5.0mm	13mm	6.3mm	304 S/S	\$490.00

5/16 UNC

PART NO.	LENGTH	DRIVE SIZE	HEAD DIA	HEAD HEIGHT	THREAD DEPTH	OUTSIDE DIA	MATERIAL	\$/100
RTCN5/16S	27mm	T45	19mm	6mm	18mm	9.6mm	304 S/S	\$750.00

3/8 UNC

PART NO.	LENGTH	DRIVE SIZE	HEAD DIA	HEAD HEIGHT	THREAD DEPTH	OUTSIDE DIA	MATERIAL	\$/100
RTCN3/8S	32mm	T50	23mm	7.5mm	22mm	12.6mm	304 S/S	\$1,900.00

RESYTORK BUTTON HEAD BARREL NUTS

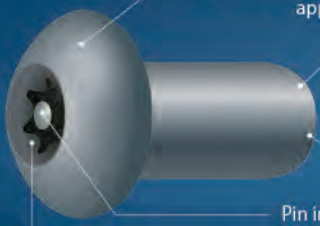

Domed button head shape has excellent visual effect and safety benefits. Thread is inside the sleeve of the barrel nut, ideal for clamping applications where both sides are visible.

Stocked in 304 Stainless steel, Galvanised and Zinc Plated.

Internally threaded with metric and imperial options.

Pin in recess to resist tampering.

6 Lobe high torque drive with chamfer to assist driver tool insertion.

LEVEL 1:
Basic Security



Can be installed and removed with the following tools:



Insert Bit

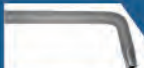

Key Wrench



Screwdriver

See page 134 - For more details on Driver Tools



PART NO.	LENGTH	DRIVE SIZE	HEAD DIA	HEAD HEIGHT	THREAD DEPTH	OUTSIDE DIA	MATERIAL	\$/100
RTBN0410	10mm	T20	9.2mm	2.75mm	6mm	5.2mm	304 S/S	\$168.00



We can supply broken packs; just add 20% to the price.

PART NO.	LENGTH	DRIVE SIZE	HEAD DIA	HEAD HEIGHT	THREAD DEPTH	OUTSIDE DIA	MATERIAL	\$/100
RTBN0510	10mm	T25	10.2mm	3.3mm	6mm	6.3mm	304 S/S	\$209.00



PART NO.	LENGTH	DRIVE SIZE	HEAD DIA	HEAD HEIGHT	THREAD DEPTH	OUTSIDE DIA	MATERIAL	\$/100
RTBN0612	12mm	T30	11.8mm	4.4mm	9mm	8mm	304 S/S	\$265.00
RTBN0625	25mm	T30	11.8mm	4.4mm	20mm	8mm	304 S/S	\$320.00



PART NO.	LENGTH	DRIVE SIZE	HEAD DIA	HEAD HEIGHT	THREAD DEPTH	OUTSIDE DIA	MATERIAL	\$/100
RTBN0816	16mm	T40	14.6mm	5mm	12mm	10mm	304 S/S	\$368.00
RTBN0830	30mm	T40	14.6mm	5mm	25mm	10mm	304 S/S	\$458.00

RESYTORK BUTTON HEAD BARREL NUTS

Domed button head shape has excellent visual effect and safety benefits. Thread is inside the sleeve of the barrel nut, ideal for clamping applications where both sides are visible.

Stocked in 304 Stainless steel, Galvanised and Zinc Plated.

Internally threaded with metric and imperial options.

Pin in recess to resist tampering.

6 Lobe high torque drive with chamfer to assist driver tool insertion.

LEVEL 1:
Basic Security

Can be installed and removed with the following tools:

- Insert Bit
- Key Wrench
- Screwdriver

See page 134 - For more details on Driver Tools

M10

PART NO.	LENGTH	DRIVE SIZE	HEAD DIA	HEAD HEIGHT	THREAD DEPTH	OUTSIDE DIA	MATERIAL	\$/100
RTBN1020	20mm	T45	18.5mm	5.8mm	14mm	12.5mm	304 S/S	\$485.00
RTBN10-Z	28mm	T45	21mm	6mm	20mm	13.5mm	Zinc	\$175.00
RTBN10-G	28mm	T45	21mm	6mm	20mm	13.5mm	Galvanised	\$195.00
RTBN1028	28mm	T45	22mm	7mm	22.5mm	13.8mm	304 S/S	\$500.00

M12

PART NO.	LENGTH	DRIVE SIZE	HEAD DIA	HEAD HEIGHT	THREAD DEPTH	OUTSIDE DIA	MATERIAL	\$/100
RTBN12-G	35mm	T50	25.2mm	5mm	24mm	16.5mm	Galvanised	\$300.00

M12 S/S STELLAR OPTION
on page 118

Other M12 S/S options
by special order



RESYTORK BUTTON HEAD BARREL NUTS

Domed button head shape has excellent visual effect and safety benefits. Thread is inside the sleeve of the barrel nut, ideal for clamping applications where both sides are visible.

Stocked in 304 Stainless steel and Zinc Plated.

Internally threaded with metric and imperial options.

Pin in recess to resist tampering.

6 Lobe high torque drive with chamfer to assist driver tool insertion.

LEVEL 1:
Basic Security

Can be installed and removed with the following tools:

- Insert Bit
- Key Wrench
- Screwdriver

See page 134 - For more details on Driver Tools

10-24 UNC

PART NO.	LENGTH	DRIVE SIZE	HEAD DIA	HEAD HEIGHT	THREAD DEPTH	OUTSIDE DIA	MATERIAL	\$/100
RTBN3/16F-S	19mm	T27	11mm	3.5mm	15mm	6.3mm	304 S/S	\$490.00

5/16 UNC

PART NO.	LENGTH	DRIVE SIZE	HEAD DIA	HEAD HEIGHT	THREAD DEPTH	OUTSIDE DIA	MATERIAL	\$/100
RTBN5/16F-S	19mm	T45	16.5mm	5mm	15mm	9.5mm	304 S/S	\$750.00

3/8 UNC

PART NO.	LENGTH	DRIVE SIZE	HEAD DIA	HEAD HEIGHT	THREAD DEPTH	OUTSIDE DIA	MATERIAL	\$/100
RTBN3/8-S	16mm	T45	23mm	6mm	14mm	12.7mm	304 S/S	\$500.00
RTBN3/8-Z	28mm	T45	21mm	6mm	20mm	13.8mm	Zinc	\$175.00



PENTAFORCE COUNTERSUNK MACHINE SCREWS

5 Sided Pentagon recess to stop all standard driver tool shapes, only the registered Pentaforce™ driver tools can be used for installation and removal.

Stocked in 304 Stainless steel, other materials can be made to order.

Imperial threads can be produced on request.

Pin in recess to resist tampering.

Countersunk head seats flush with material.

LEVEL 2: High Security

Can be installed and removed with the following tools:

Insert Bit

Key Wrench

See page 135 - For more details on Driver Tools

M4

Pentagon shape – Hex tools won't fit!

PART NO.	LENGTH	DRIVE SIZE	HEAD DIA	HEAD HEIGHT	MATERIAL	\$/100
PFCM410	10mm	PFD00	7.8mm	2.4mm	304 S/S	\$223.00
PFCM420	20mm	PFD00	7.8mm	2.4mm	304 S/S	\$230.00
PFCM440	40mm	PFD00	7.8mm	2.4mm	304 S/S	\$267.00

M5

PART NO.	LENGTH	DRIVE SIZE	HEAD DIA	HEAD HEIGHT	MATERIAL	\$/100
PFCM510	10mm	PFD0	9.2mm	3.0mm	304 S/S	\$230.00
PFCM516	16mm	PFD0	9.2mm	3.0mm	304 S/S	\$250.00
PFCM525	25mm	PFD0	9.2mm	3.0mm	304 S/S	\$260.00
PFCM535	35mm	PFD0	9.2mm	3.0mm	304 S/S	\$271.00
PFCM540	40mm	PFD0	9.2mm	3.0mm	304 S/S	\$284.00
PFCM560	60mm	PFD0	9.2mm	3.0mm	304 S/S	\$307.00



PENTAFORCE COUNTERSUNK MACHINE SCREWS

5 Sided Pentagon recess to stop all standard driver tool shapes, only the registered Pentaforce™ driver tools can be used for installation and removal.

Stocked in 304 Stainless steel, other materials can be made to order.

Imperial threads can be produced on request.

Pin in recess to resist tampering.

Countersunk head seats flush with material.

LEVEL 2: High Security

Can be installed and removed with the following tools:

Insert Bit

Key Wrench

See page 135 - For more details on Driver Tools

M6

Pentagon shape – Hex tools won't fit!

PART NO.	LENGTH	DRIVE SIZE	HEAD DIA	HEAD HEIGHT	MATERIAL	\$/100
PFCM610	10mm	PFD1	11.5mm	3.5mm	304 S/S	\$264.00
PFCM620	20mm	PFD1	11.5mm	3.5mm	304 S/S	\$271.00
PFCM630	30mm	PFD1	11.5mm	3.5mm	304 S/S	\$280.00
PFCM640	40mm	PFD1	11.5mm	3.5mm	304 S/S	\$297.00
PFCM650	50mm	PFD1	11.5mm	3.5mm	304 S/S	\$330.00

M8

PART NO.	LENGTH	DRIVE SIZE	HEAD DIA	HEAD HEIGHT	MATERIAL	\$/100
PFCM825	25mm	PFD2	15.5mm	4.9mm	304 S/S	\$397.00
PFCM850	50mm	PFD2	15.5mm	4.9mm	304 S/S	\$480.00



PENTAFORCE BUTTON HEAD MACHINE SCREWS

5 Sided Pentagon recess to stop all standard driver tool shapes, only the registered Pentaforce™ driver tools can be used for installation and removal.

Stocked in 304 Stainless steel, other materials can be made to order.

Imperial threads can be produced on request.

Pin in recess to resist tampering.

Domed button head shape has excellent visual effect and safety benefits.

LEVEL 2: High Security

Can be installed and removed with the following tools:

Insert Bit

Key Wrench

See page 135 - For more details on Driver Tools

M3

Pentagon shape – Hex tools won't fit!

PART NO.	LENGTH	DRIVE SIZE	HEAD DIA	HEAD HEIGHT	MATERIAL	\$/100
PFBM308	8mm	PFD000	5.6mm	1.7mm	304 S/S	\$210.00

M4

PART NO.	LENGTH	DRIVE SIZE	HEAD DIA	HEAD HEIGHT	MATERIAL	\$/100
PFBM408	8mm	PFD00	7.5mm	2.2mm	304 S/S	\$214.00
PFBM412	12mm	PFD00	7.5mm	2.2mm	304 S/S	\$225.00
PFBM416	16mm	PFD00	7.5mm	2.2mm	304 S/S	\$233.00

M5

PART NO.	LENGTH	DRIVE SIZE	HEAD DIA	HEAD HEIGHT	MATERIAL	\$/100
PFBM510	10mm	PFD0	9.5mm	2.7mm	304 S/S	\$230.00
PFBM516	16mm	PFD0	9.5mm	2.7mm	304 S/S	\$250.00

We can supply broken packs; just add 20% to the price.

PENTAFORCE BUTTON HEAD MACHINE SCREWS

5 Sided Pentagon recess to stop all standard driver tool shapes, only the registered Pentaforce™ driver tools can be used for installation and removal.

Stocked in 304 Stainless steel, other materials can be made to order.

Imperial threads can be produced on request.

Pin in recess to resist tampering.

Domed button head shape has excellent visual effect and safety benefits.

LEVEL 2: High Security

Can be installed and removed with the following tools:

Insert Bit

Key Wrench

See page 135 - For more details on Driver Tools

M6

Pentagon shape – Hex tools won't fit!

PART NO.	LENGTH	DRIVE SIZE	HEAD DIA	HEAD HEIGHT	MATERIAL	\$/100
PFBM608	8mm	PFD1	10.4mm	3.4mm	304 S/S	\$260.00
PFBM612	12mm	PFD1	10.4mm	3.4mm	304 S/S	\$265.00
PFBM616	16mm	PFD1	10.4mm	3.4mm	304 S/S	\$267.00
PFBM620	20mm	PFD1	10.4mm	3.4mm	304 S/S	\$271.00
PFBM625	25mm	PFD1	10.4mm	3.4mm	304 S/S	\$274.00
PFBM630	30mm	PFD1	10.4mm	3.4mm	304 S/S	\$280.00
PFBM635	35mm	PFD1	10.4mm	3.4mm	304 S/S	\$285.00
PFBM640	40mm	PFD1	10.4mm	3.4mm	304 S/S	\$297.00
PFBM660	60mm	PFD1	10.4mm	3.4mm	304 S/S	\$340.00

M8

PART NO.	LENGTH	DRIVE SIZE	HEAD DIA	HEAD HEIGHT	MATERIAL	\$/100
PFBM812	12mm	PFD2	13.8mm	4.2mm	304 S/S	\$324.00
PFBM825	25mm	PFD2	13.8mm	4.2mm	304 S/S	\$395.00
PFBM830	30mm	PFD2	13.8mm	4.2mm	304 S/S	\$425.00
PFBM840	40mm	PFD2	13.8mm	4.2mm	304 S/S	\$460.00

Pentaforce screws can also be supplied in Zinc or Galvanised by special order, Minimum quantity as low as 500pce.

PENTAFORCE COUNTERSUNK SELF TAPPERS

5 Sided Pentagon recess to stop all standard driver tool shapes, only the registered Pentaforce™ driver tools can be used for installation and removal.

Sharp threaded taper point for accurate locating and positive drive thrust.

Sharp self-tapping thread precision manufactured in 304 Stainless steel.

Pin in recess to resist tampering.

Countersunk head seats flush with material.

LEVEL 2: High Security

Can be installed and removed with the following tools:

Insert Bit

Key Wrench

See page 135 - For more details on Driver Tools

6G

Pentagon shape – Hex tools won't fit!

PART NO.	LENGTH	DRIVE SIZE	HEAD DIA	HEAD HEIGHT	MATERIAL	\$/100
PFC56F	3/4" (19mm)	PFD00	6.7mm	2.1mm	304 S/S	\$223.00

8G

PART NO.	LENGTH	DRIVE SIZE	HEAD DIA	HEAD HEIGHT	MATERIAL	\$/100
PFC58G	1" (25mm)	PFD0	8mm	2.5mm	304 S/S	\$245.00
PFC58J	2" (50mm)	PFD0	8mm	2.5mm	304 S/S	\$280.00



PENTAFORCE COUNTERSUNK SELF TAPPERS

5 Sided Pentagon recess to stop all standard driver tool shapes, only the registered Pentaforce™ driver tools can be used for installation and removal.

Sharp threaded taper point for accurate locating and positive drive thrust.

Sharp self-tapping thread precision manufactured in 304 Stainless steel.

Pin in recess to resist tampering.

Countersunk head seats flush with material.

LEVEL 2:
High Security

Can be installed and removed with the following tools:

Insert Bit

Key Wrench

See page 135 - For more details on Driver Tools

10G

Pentagon shape – Hex tools won't fit!

PART NO.	LENGTH	DRIVE SIZE	HEAD DIA	HEAD HEIGHT	MATERIAL	\$/100
PFC10F	3/4" (19mm)	PFD0	9.5mm	3.0mm	304 S/S	\$250.00
PFC10G	1" (25mm)	PFD0	9.5mm	3.0mm	304 S/S	\$260.00
PFC10H	1 1/4" (32mm)	PFD0	9.5mm	3.0mm	304 S/S	\$273.00
PFC10I	1 1/2" (38mm)	PFD0	9.5mm	3.0mm	304 S/S	\$284.00
PFC10J	2" (50mm)	PFD0	9.5mm	3.0mm	304 S/S	\$293.00
PFC10K	2 1/2" (63mm)	PFD0	9.5mm	3.0mm	304 S/S	\$307.00

12G

PART NO.	LENGTH	DRIVE SIZE	HEAD DIA	HEAD HEIGHT	MATERIAL	\$/100
PFC12G	1" (25mm)	PFD1	10.2mm	4.0mm	304 S/S	\$274.00
PFC12J	2" (50mm)	PFD1	10.2mm	4.0mm	304 S/S	\$330.00



PENTAFORCE BUTTON HEAD SELF TAPPERS

5 Sided Pentagon recess to stop all standard driver tool shapes, only the registered Pentaforce™ driver tools can be used for installation and removal.

Sharp threaded taper point for accurate locating and positive drive thrust.

Sharp self-tapping thread precision manufactured in 304 Stainless steel.

Pin in recess to resist tampering.

Domed button head shape has excellent visual effect and safety benefits.

LEVEL 2:
High Security

Can be installed and removed with the following tools:

Insert Bit

Key Wrench

See page 135 - For more details on Driver Tools

6G

Pentagon shape – Hex tools won't fit!

PART NO.	LENGTH	DRIVE SIZE	HEAD DIA	HEAD HEIGHT	MATERIAL	\$/100
PFBS6I	1 1/2" (38mm)	PFD000	6.7mm	2.5mm	304 S/S	\$267.00

8G

PART NO.	LENGTH	DRIVE SIZE	HEAD DIA	HEAD HEIGHT	MATERIAL	\$/100
PFBS8D	1/2" (13mm)	PFD00	7.5mm	2.2mm	304 S/S	\$230.00
PFBS8F	3/4" (19mm)	PFD00	7.5mm	2.2mm	304 S/S	\$234.00
PFBS8G	1" (25mm)	PFD00	7.5mm	2.2mm	304 S/S	\$245.00
PFBS8H	1 1/4" (32mm)	PFD00	7.5mm	2.2mm	304 S/S	\$264.00
PFBS8I	1 1/2" (38mm)	PFD00	7.5mm	2.2mm	304 S/S	\$271.00
PFBS8J	2" (50mm)	PFD00	7.5mm	2.2mm	304 S/S	\$280.00



PENTAFORCE BUTTON HEAD SELF TAPPERS

5 Sided Pentagon recess to stop all standard driver tool shapes, only the registered Pentaforce™ driver tools can be used for installation and removal.

Sharp threaded taper point for accurate locating and positive drive thrust.

Sharp self-tapping thread precision manufactured in 304 Stainless steel.

Pin in recess to resist tampering.

Domed button head shape has excellent visual effect and safety benefits.

LEVEL 2: High Security

Can be installed and removed with the following tools:

Insert Bit

Key Wrench

See page 135 - For more details on Driver Tools

10G

Pentagon shape – Hex tools won't fit!

PART NO.	LENGTH	DRIVE SIZE	HEAD DIA	HEAD HEIGHT	MATERIAL	\$/100
PFBS10F	3/4" (19mm)	PFD0	9.2mm	2.8mm	304 S/S	\$250.00
PFBS10G	1" (25mm)	PFD0	9.2mm	2.8mm	304 S/S	\$260.00
PFBS10H	1 1/4" (32mm)	PFD0	9.2mm	2.8mm	304 S/S	\$273.00
PFBS10I	1 1/2" (38mm)	PFD0	9.2mm	2.8mm	304 S/S	\$284.00
PFBS10J	2" (50mm)	PFD0	9.2mm	2.8mm	304 S/S	\$293.00

12G

PART NO.	LENGTH	DRIVE SIZE	HEAD DIA	HEAD HEIGHT	MATERIAL	\$/100
PFBS12G	1" (25mm)	PFD1	10.0mm	3.0mm	304 S/S	\$274.00
PFBS12J	2" (50mm)	PFD1	10.0mm	3.0mm	304 S/S	\$330.00



PENTAFORCE PAN HEAD TYPE 17 SCREWS



5 Sided Pentagon recess to stop all standard driver tool shapes, only the registered Pentaforce™ driver tools can be used for installation and removal.

Type 17 tip to assist self-drilling into timber.

Stocked in Galvanised steel. Other can be made to order, subject to minimum order quantities.

Pin in recess to resist tampering.

Pan head shape.

LEVEL 2:
High Security



Can be installed and removed with the following tools:



Insert Bit

See page 135 - For more details on Driver Tools

10G



Pentagon shape – Hex tools won't fit!

PART NO.	LENGTH	DRIVE SIZE	HEAD DIA	HEAD HEIGHT	MATERIAL	\$/100	\$/1000
PFPT10F	3/4" (19mm)	PFD1	9.0mm	3.3mm	Galvanised	\$18.96	\$158.00
PFPT10G	1" (25mm)	PFD1	9.0mm	3.3mm	Galvanised	\$20.40	\$170.00
PFPT10I	1 1/2" (38mm)	PFD1	9.0mm	3.3mm	Galvanised	\$24.96	\$208.00

12G



PART NO.	LENGTH	DRIVE SIZE	HEAD DIA	HEAD HEIGHT	MATERIAL	\$/100	\$/1000
PFPT12H	1 1/4" (32mm)	PFD1	10.0mm	4.3mm	Galvanised	\$38.40	\$320.00
PFPT12J	2" (50mm)	PFD1	10.0mm	4.3mm	Galvanised	\$47.40	\$395.00



PENTAFORCE PAN HEAD SELF DRILLING SCREWS



5 Sided Pentagon recess to stop all standard driver tool shapes, only the registered Pentaforce™ driver tools can be used for installation and removal.

Self-drilling tip for effective pre-drilling maximises work efficiency and down time.

Stocked in Galvanised steel. Other can be made to order, subject to minimum order quantities.

Pin in recess to resist tampering.

Pan head shape.

LEVEL 2:
High Security



Can be installed and removed with the following tools:



Insert Bit

See page 135 - For more details on Driver Tools

8G



Pentagon shape – Hex tools won't fit!

PART NO.	LENGTH	DRIVE SIZE	HEAD DIA	HEAD HEIGHT	MATERIAL	\$/100	\$/1000
PFPSD8C	3/8" (9.5mm)	PFD1	8.0mm	2.9mm	Galvanised	\$26.50	\$125.00
PFPSD8D	1/2" (13mm)	PFD1	8.0mm	2.9mm	Galvanised	\$28.00	\$130.00
PFPSD8F	3/4" (19mm)	PFD1	8.0mm	2.9mm	Galvanised	\$30.00	\$155.00
PFPSD8G	1" (25mm)	PFD1	8.0mm	2.9mm	Galvanised	\$32.00	\$185.00

10G



PART NO.	LENGTH	DRIVE SIZE	HEAD DIA	HEAD HEIGHT	MATERIAL	\$/100	\$/1000
PFPSD10E	5/8" (16mm)	PFD1	9.3mm	3.4mm	Galvanised	\$30.00	\$210.00
PFPSD10G	1" (25mm)	PFD1	9.3mm	3.4mm	Galvanised	\$32.00	\$235.00
PFPSD10I	1 1/2" (38mm)	PFD1	9.3mm	3.4mm	Galvanised	\$38.00	\$285.00



Ideal for securing Cladding and Roofing

PENTAFORCE PAN HEAD SELF DRILLING SCREWS

5 Sided Pentagon recess to stop all standard driver tool shapes, only the registered Pentaforce™ driver tools can be used for installation and removal.

Self-drilling tip for effective pre-drilling maximises work efficiency and down time.

Stocked in Galvanised steel. Other can be made to order, subject to minimum order quantities.

Pan head shape.

Pin in recess to resist tampering.

LEVEL 2: High Security

Can be installed and removed with the following tools:

Insert Bit

See page 135 - For more details on Driver Tools

12G

Pentagon shape – Hex tools won't fit!

PART NO.	LENGTH	DRIVE SIZE	HEAD DIA	HEAD HEIGHT	MATERIAL	\$/100	\$/1000
PFPSD12G	1" (25mm)	PFD2	10.5mm	3.8mm	Galvanised	\$38.60	\$290.00
PFPSD12I	1 1/2" (38mm)	PFD2	10.5mm	3.8mm	Galvanised	\$45.20	\$339.00
PFPSD12J	2" (50mm)	PFD2	10.5mm	3.8mm	Galvanised	\$52.65	\$395.00
PFPSD12K	2 1/2" (63mm)	PFD2	10.5mm	3.8mm	Galvanised	\$55.33	\$415.00

14G

PART NO.	LENGTH	DRIVE SIZE	HEAD DIA	HEAD HEIGHT	MATERIAL	\$/100	\$/1000
PFPSD14G	1" (25mm)	PFD2	12.4mm	4.4mm	Galvanised	\$50.65	\$380.00
PFPSD14J	2" (50mm)	PFD2	12.4mm	4.4mm	Galvanised	\$64.80	\$540.00
PFPSD14K	2 1/2" (63mm)	PFD2	12.4mm	4.4mm	Galvanised	\$74.40	\$620.00

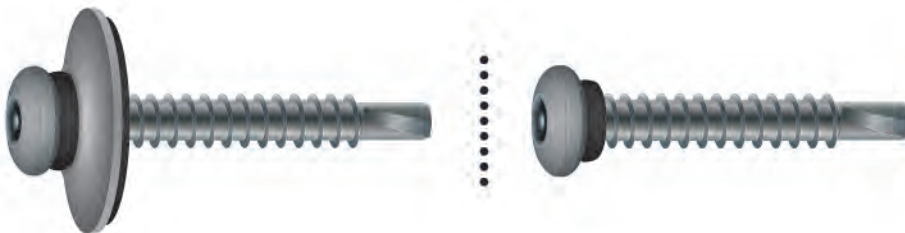

Can also be fitted with neo or bonded washers for roofing and cladding applications.

PENTAFORCE P500 EXTENDED POINT SELF DRILLING SCREWS

5 Sided Pentagon recess to stop all standard driver tool shapes, only the registered Pentaforce™ driver tools can be used for installation and removal.

Series 500 Drilling tip for heavy duty steel drilling.

Stocked in Galvanised steel. Other can be made to order, subject to minimum order quantities.

Pan head shape.

LEVEL 2:
High Security

Can be installed and removed with the following tools:

Insert Bit

See page 135 - For more details on Driver Tools

12G

Stock due in Mid 2015

PART NO.	LENGTH	DRIVE SIZE	HEAD DIA	HEAD HEIGHT	MATERIAL	\$/100	\$/1000
PFPSD50012H	32mm	PFD2	10.5mm	3.95mm	Galvanised	\$55.00	\$397.00
PFPSD50012J	50mm	PFD2	10.5mm	3.95mm	Galvanised	\$65.00	\$495.00
PFPSD50012K	65mm	PFD2	10.5mm	3.95mm	Galvanised	\$70.00	\$525.00



PIN HEX COUNTERSUNK MACHINE SCREWS

Countersunk head seats flush with material. Other special head shapes can be custom manufactured to order.

Precision manufactured in 304 Stainless steel. 316 Stainless steel, Zinc and Galvanised versions can be batch produced on request.

Imperial threads available see page 51

Pin in recess to resist tampering.

High torque hex drive with chamfer to assist driver tool insertion.

LEVEL 1:
Basic Security

Can be installed and removed with the following tools:

Insert Bit

Key Wrench

See page 137 - For more details on Driver Tools

M3

● = Metric Drive Recess

PART NO.	LENGTH	DRIVE SIZE	HEAD DIA	HEAD HEIGHT	MATERIAL	\$/100	
PHCM306-M	6mm	H2M	5.5mm	1.7mm	304 S/S	\$104.60	●
PHCM310	10mm	H20	5.5mm	1.7mm	304 S/S	\$109.40	
PHCM312	12mm	H20	5.5mm	1.7mm	304 S/S	\$110.80	
PHCM316	16mm	H20	5.5mm	1.7mm	304 S/S	\$113.40	
PHCM320	20mm	H20	5.5mm	1.7mm	304 S/S	\$115.60	

M4

PART NO.	LENGTH	DRIVE SIZE	HEAD DIA	HEAD HEIGHT	MATERIAL	\$/100	
PHCM406-M	6mm	H25M	7.8mm	2.3mm	304 S/S	\$69.00	●
PHCM408	8mm	H40	7.8mm	2.3mm	304 S/S	\$71.80	
PHCM408-M	8mm	H25M	7.8mm	2.3mm	304 S/S	\$75.40	●
PHCM410	10mm	H40	7.8mm	2.3mm	304 S/S	\$76.00	
PHCM410-M	10mm	H25M	7.8mm	2.3mm	304 S/S	\$76.00	●
PHCM412	12mm	H40	7.8mm	2.1mm	304 S/S	\$77.40	
PHCM412-M	12mm	H25M	7.8mm	2.3mm	304 S/S	\$77.40	●
PHCM414	14mm	H40	7.8mm	2.3mm	304 S/S	\$79.00	
PHCM416	16mm	H40	7.8mm	2.3mm	304 S/S	\$80.00	
PHCM416-M	16mm	H25M	7.8mm	2.3mm	304 S/S	\$80.00	●
PHCM420	20mm	H40	7.8mm	2.3mm	304 S/S	\$85.10	
PHCM425	25mm	H40	7.8mm	2.3mm	304 S/S	\$90.90	
PHCM425-M	25mm	H25M	7.8mm	2.3mm	304 S/S	\$90.90	●
PHCM430	30mm	H40	7.8mm	2.3mm	304 S/S	\$109.10	
PHCM440	40mm	H40	7.8mm	2.3mm	304 S/S	\$125.80	
PHCM450	50mm	H40	7.8mm	2.3mm	304 S/S	\$340.00	

PIN HEX COUNTERSUNK MACHINE SCREWS

Countersunk head seats flush with material. Other special head shapes can be custom manufactured to order.

Precision manufactured in 304 Stainless steel. 316 Stainless steel, Zinc and Galvanised versions can be batch produced on request.

Imperial threads available see page 51

Pin in recess to resist tampering.

High torque hex drive with chamfer to assist driver tool insertion.

LEVEL 1:
Basic Security

Can be installed and removed with the following tools:

Insert Bit

Key Wrench

See page 137 - For more details on Driver Tools



● = Metric Drive Recess

PART NO.	LENGTH	DRIVE SIZE	HEAD DIA	HEAD HEIGHT	MATERIAL	\$/100
PHCM508	8mm	H40	9.8mm	2.8mm	304 S/S	\$94.00
PHCM510	10mm	H40	9.8mm	2.8mm	304 S/S	\$96.50
PHCM510-M	10mm	H3M	9.8mm	2.8mm	304 S/S	\$96.50 ●
PHCM512	12mm	H40	9.8mm	2.8mm	304 S/S	\$98.60
PHCM512-M	12mm	H3M	9.8mm	2.8mm	304 S/S	\$98.60 ●
PHCM516	16mm	H40	9.8mm	2.8mm	304 S/S	\$104.00
PHCM520	20mm	H40	9.8mm	2.8mm	304 S/S	\$110.10
PHCM520-M	20mm	H3M	9.8mm	2.8mm	304 S/S	\$110.10 ●
PHCM525	25mm	H40	9.8mm	2.8mm	304 S/S	\$122.80
PHCM530	30mm	H40	9.8mm	2.8mm	304 S/S	\$130.60
PHCM540	40mm	H40	9.8mm	2.8mm	304 S/S	\$152.10
PHCM550	50mm	H40	9.8mm	2.8mm	304 S/S	\$168.90
PHCM560	60mm	H40	9.8mm	2.8mm	304 S/S	\$199.00



PIN HEX COUNTERSUNK MACHINE SCREWS

Countersunk head seats flush with material. Other special head shapes can be custom manufactured to order.

Precision manufactured in 304 Stainless steel, 316 Stainless steel, Zinc and Galvanised versions can be batch produced on request.

Imperial threads available see page 51

Pin in recess to resist tampering.

High torque hex drive with chamfer to assist driver tool insertion.

LEVEL 1:
Basic Security

Can be installed and removed with the following tools:

Insert Bit

Key Wrench

See page 137 - For more details on Driver Tools



PART NO.	LENGTH	DRIVE SIZE	HEAD DIA	HEAD HEIGHT	MATERIAL	\$/100
PHCM608	8mm	H40	11.8mm	3.3mm	304 S/S	\$104.80
PHCM610	10mm	H40	11.8mm	3.3mm	304 S/S	\$106.20
PHCM612	12mm	H40	11.8mm	3.3mm	304 S/S	\$107.00
PHCM616	16mm	H40	11.8mm	3.3mm	304 S/S	\$108.30
PHCM620	20mm	H40	11.8mm	3.3mm	304 S/S	\$116.50
PHCM625	25mm	H40	11.8mm	3.3mm	304 S/S	\$134.00
PHCM630	30mm	H40	11.8mm	3.3mm	304 S/S	\$142.50
PHCM640	40mm	H40	11.8mm	3.3mm	304 S/S	\$165.70
PHCM645	45mm	H40	11.8mm	3.3mm	304 S/S	\$175.70
PHCM650	50mm	H40	11.8mm	3.3mm	304 S/S	\$184.40
PHCM660	60mm	H40	11.8mm	3.3mm	304 S/S	\$215.90
PHCM675	75mm	H40	11.8mm	3.3mm	304 S/S	\$244.40



PIN HEX COUNTERSUNK MACHINE SCREWS

Countersunk head seats flush with material. Other special head shapes can be custom manufactured to order.

Precision manufactured in 304 Stainless steel. 316 Stainless steel, Zinc and Galvanised versions can be batch produced on request.

Imperial threads available see page 51

Pin in recess to resist tampering.

High torque hex drive with chamfer to assist driver tool insertion.

LEVEL 1:
Basic Security

Can be installed and removed with the following tools:



Insert Bit



Key Wrench

See page 137 - For more details on Driver Tools

M8

PART NO.	LENGTH	DRIVE SIZE	HEAD DIA	HEAD HEIGHT	MATERIAL	\$/100
PHCM812	12mm	H50	15.7mm	5.2mm	304 S/S	\$183.10
PHCM816	16mm	H50	15.7mm	5.2mm	304 S/S	\$183.10
PHCM820	20mm	H50	15.7mm	5.2mm	304 S/S	\$197.40
PHCM825	25mm	H50	15.7mm	5.2mm	304 S/S	\$215.90
PHCM830	30mm	H50	15.7mm	5.2mm	304 S/S	\$243.20
PHCM835	35mm	H50	15.7mm	5.2mm	304 S/S	\$296.80
PHCM840	40mm	H50	15.7mm	5.2mm	304 S/S	\$281.10
PHCM850	50mm	H50	15.7mm	5.2mm	304 S/S	\$316.20
PHCM860	60mm	H50	15.7mm	5.2mm	304 S/S	\$367.70

M10

PART NO.	LENGTH	DRIVE SIZE	HEAD DIA	HEAD HEIGHT	MATERIAL	\$/100
PHCM1020	20mm	H60	19.7mm	6.3mm	304 S/S	\$325.80
PHCM1025	25mm	H60	19.7mm	6.3mm	304 S/S	\$357.50
PHCM1030	30mm	H60	19.7mm	6.3mm	304 S/S	\$374.10
PHCM1040	40mm	H60	19.7mm	6.3mm	304 S/S	\$399.00
PHCM1050	50mm	H60	19.7mm	6.3mm	304 S/S	\$446.40
PHCM1060	60mm	H60	19.7mm	6.3mm	304 S/S	\$479.20

PIN HEX COUNTERSUNK MACHINE SCREWS

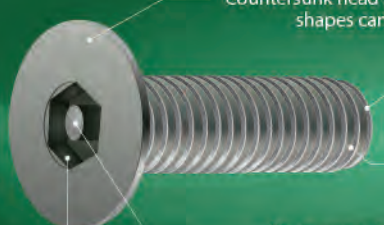

Countersunk head seats flush with material. Other special head shapes can be custom manufactured to order.

Precision manufactured in 304 Stainless steel, 316 Stainless steel, Zinc and Galvanised versions can be batch produced on request.

Imperial threads available see page 51

Pin in recess to resist tampering.

High torque hex drive with chamfer to assist driver tool insertion.

LEVEL 1:
Basic Security



Can be installed and removed with the following tools:



Insert Bit



Key Wrench

See page 137 - For more details on Driver Tools

M12



PART NO.	LENGTH	DRIVE SIZE	HEAD DIA	HEAD HEIGHT	MATERIAL	\$/100
PHCM1220	20mm	H80	23.6mm	7.5mm	304 S/S	\$1,090.50
PHCM1225	25mm	H80	23.6mm	7.5mm	304 S/S	\$1,109.00
PHCM1230	30mm	H80	23.6mm	7.5mm	304 S/S	\$1,114.00
PHCM1240	40mm	H80	23.6mm	7.5mm	304 S/S	\$1,120.00
PHCM1250	50mm	H80	23.6mm	7.5mm	304 S/S	\$1,209.00
PHCM1260	60mm	H80	23.6mm	7.5mm	304 S/S	\$1,446.00

PIN HEX IMPERIAL COUNTERSUNK MACHINE SCREWS

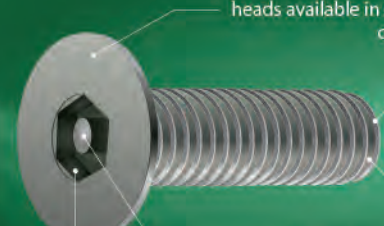

Countersunk head seats flush with material. Undercut heads available in selected sizes. Other special head shapes can be custom manufactured to order.

Precision manufactured in 304 Stainless steel, 316 Stainless steel, Zinc and Galvanised versions can be batch produced on request.

Metric threads available see pages 45-50

Pin in recess to resist tampering.

High torque hex drive with chamfer to assist driver tool insertion.

LEVEL 1:
Basic Security



Other sizes available to order.

10-24 UNC



PART NO.	LENGTH	DRIVE SIZE	HEAD DIA	HEAD HEIGHT	MATERIAL	\$/100
PHCM1024C	3/8" (9.5mm)	H40	9.4mm	4mm	304 S/S	\$92.00
PHCM1024G	1" (25mm)	H40	9.4mm	4mm	304 S/S	\$99.00

PIN HEX BUTTON HEAD MACHINE SCREWS

Domed button head shape has excellent visual effect and safety benefits. Other special head shapes can be custom manufactured to order.

Stocked in 304 Stainless steel with selected sizes available in 316 Stainless steel. Zinc and Galvanised versions can be made to order.

Imperial threads available see page 58

Pin in recess to resist tampering.

High torque hex drive with chamfer to assist driver tool insertion.

LEVEL 1:
Basic Security

Can be installed and removed with the following tools:

Insert Bit

Key Wrench

See page 137 - For more details on Driver Tools

M3

● = Metric Drive Recess

PART NO.	LENGTH	DRIVE SIZE	HEAD DIA	HEAD HEIGHT	MATERIAL	\$/100
PHBM310	10mm	H20	5.5mm	1.7mm	304 S/S	\$109.40
PHBM312	12mm	H20	5.5mm	1.7mm	304 S/S	\$110.80
PHBM312-M	12mm	H2M	5.5mm	1.7mm	304 S/S	\$110.80
PHBM316	16mm	H20	5.5mm	1.7mm	304 S/S	\$113.40
PHBM316-M	16mm	H2M	5.5mm	1.7mm	304 S/S	\$113.40
PHBM320	20mm	H20	5.5mm	1.7mm	304 S/S	\$115.60

M4

PART NO.	LENGTH	DRIVE SIZE	HEAD DIA	HEAD HEIGHT	MATERIAL	\$/100
PHBM406-M	6mm	H25M	7.8mm	2.1mm	304 S/S	\$69.00
PHBM408	8mm	H40	7.8mm	2.1mm	304 S/S	\$71.80
PHBM408-M	8mm	H25M	7.8mm	2.1mm	304 S/S	\$71.80
PHBM410	10mm	H40	7.8mm	2.1mm	304 S/S	\$76.00
PHBM410-M	10mm	H25M	7.8mm	2.1mm	304 S/S	\$76.00
PHBM412	12mm	H40	7.8mm	2.1mm	304 S/S	\$77.40
PHBM412-M	12mm	H25M	7.8mm	2.1mm	304 S/S	\$77.40
PHBM416	16mm	H40	7.8mm	2.1mm	304 S/S	\$80.00
PHBM416-M	16mm	H25M	7.8mm	2.1mm	304 S/S	\$80.00
PHBM420	20mm	H40	7.8mm	2.1mm	304 S/S	\$85.10
PHBM420-M	20mm	H25M	7.8mm	2.1mm	304 S/S	\$85.10
PHBM425	25mm	H40	7.8mm	2.1mm	304 S/S	\$90.90
PHBM425-M	25mm	H25M	7.8mm	2.1mm	304 S/S	\$90.90
PHBM430	30mm	H40	7.8mm	2.1mm	304 S/S	\$109.10
PHBM440	40mm	H40	7.8mm	2.1mm	304 S/S	\$138.40

PIN HEX BUTTON HEAD MACHINE SCREWS

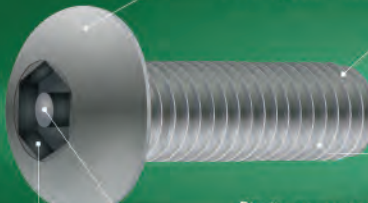

Domed button head shape has excellent visual effect and safety benefits. Other special head shapes can be custom manufactured to order.

Stocked in 304 Stainless steel with selected sizes available in 316 Stainless steel. Zinc and Galvanised versions can be made to order.

Imperial threads available see page 58

Pin in recess to resist tampering.

High torque hex drive with chamfer to assist driver tool insertion.

LEVEL 1:
Basic Security



Can be installed and removed with the following tools:



Insert Bit



Key Wrench

See page 137 - For more details on Driver Tools



● = Metric Drive Recess

PART NO.	LENGTH	DRIVE SIZE	HEAD DIA	HEAD HEIGHT	MATERIAL	\$/100
PHBM510	10mm	H40	9.3mm	2.6mm	304 S/S	\$96.50
PHBM510-M	10mm	H3M	9.3mm	2.6mm	304 S/S	\$96.50 ●
PHBM512	12mm	H40	9.3mm	2.6mm	304 S/S	\$98.60
PHBM512-M	12mm	H3M	9.3mm	2.6mm	304 S/S	\$98.60 ●
PHBM516	16mm	H40	9.3mm	2.6mm	304 S/S	\$104.00
PHBM516-M	16mm	H3M	9.3mm	2.6mm	304 S/S	\$104.00 ●
PHBM520	20mm	H40	9.3mm	2.6mm	304 S/S	\$110.10
PHBM520-M	20mm	H3M	9.3mm	2.6mm	304 S/S	\$110.10 ●
PHBM525	25mm	H40	9.3mm	2.6mm	304 S/S	\$122.80
PHBM525-M	25mm	H3M	9.3mm	2.6mm	304 S/S	\$122.80 ●
PHBM530	30mm	H40	9.3mm	2.6mm	304 S/S	\$130.60
PHBM530-M	30mm	H3M	9.3mm	2.6mm	304 S/S	\$130.60 ●
PHBM535-M	35mm	H3M	9.3mm	2.6mm	304 S/S	\$142.80 ●
PHBM540	40mm	H40	9.3mm	2.6mm	304 S/S	\$152.10
PHBM550	50mm	H40	9.3mm	2.6mm	304 S/S	\$177.40
PHBM560	60mm	H40	9.3mm	2.6mm	304 S/S	\$196.00



PIN HEX BUTTON HEAD MACHINE SCREWS

Domed button head shape has excellent visual effect and safety benefits. Other special head shapes can be custom manufactured to order.

Stocked in 304 Stainless steel with selected sizes available in 316 Stainless steel. Zinc and Galvanised versions can be made to order.

Imperial threads available see page 58

Pin in recess to resist tampering.

High torque hex drive with chamfer to assist driver tool insertion.

LEVEL 1:
Basic Security

Can be installed and removed with the following tools:

Insert Bit

Key Wrench

See page 137 - For more details on Driver Tools



● = 316 S/S

PART NO.	LENGTH	DRIVE SIZE	HEAD DIA	HEAD HEIGHT	MATERIAL	\$/100
PHBM608	8mm	H40	10.3mm	3.2mm	304 S/S	\$104.00
PHBM610	10mm	H40	10.3mm	3.2mm	304 S/S	\$106.20
PHBM612	12mm	H40	10.3mm	3.2mm	304 S/S	\$107.00
PHBM616	16mm	H40	10.3mm	3.2mm	304 S/S	\$108.30
PHBM620	20mm	H40	10.3mm	3.2mm	304 S/S	\$116.50
PHBM620-A4	20mm	H40	10.3mm	3.2mm	316 S/S	\$745.00 ●
PHBM625	25mm	H40	10.3mm	3.2mm	304 S/S	\$134.00
PHBM625-A4	25mm	H40	10.3mm	3.2mm	316 S/S	\$749.00 ●
PHBM630	30mm	H40	10.3mm	3.2mm	304 S/S	\$142.50
PHBM630-A4	30mm	H40	10.3mm	3.2mm	316 S/S	\$758.00 ●
PHBM635	35mm	H40	10.3mm	3.2mm	304 S/S	\$150.00
PHBM635-A4	35mm	H40	10.3mm	3.2mm	316 S/S	\$765.00 ●
PHBM640	40mm	H40	10.3mm	3.2mm	304 S/S	\$165.70
PHBM640-A4	40mm	H40	10.3mm	3.2mm	316 S/S	\$778.00 ●
PHBM645	45mm	H40	10.3mm	3.2mm	304 S/S	\$175.70
PHBM650	50mm	H40	10.3mm	3.2mm	304 S/S	\$184.40
PHBM660	60mm	H40	10.3mm	3.2mm	304 S/S	\$215.90
PHBM665	65mm	H40	10.3mm	3.2mm	304 S/S	\$244.40
PHBM675	75mm	H40	10.3mm	3.2mm	304 S/S	\$255.00

PIN HEX BUTTON HEAD MACHINE SCREWS

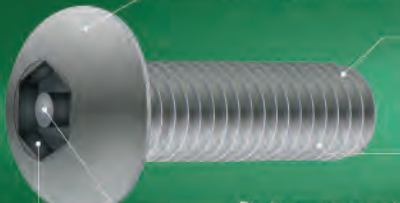

Domed button head shape has excellent visual effect and safety benefits. Other special head shapes can be custom manufactured to order.

Stocked in 304 Stainless steel with selected sizes available in 316 Stainless steel. Zinc and Galvanised versions can be made to order.

Imperial threads available see page 58

Pin in recess to resist tampering.

High torque hex drive with chamfer to assist driver tool insertion.

LEVEL 1:
Basic Security



Can be installed and removed with the following tools:



Insert Bit



Key Wrench

See page 137 - For more details on Driver Tools

M8



PART NO.	LENGTH	DRIVE SIZE	HEAD DIA	HEAD HEIGHT	MATERIAL	\$/100
PHBM810	10mm	H50	13.7mm	4.4mm	304 S/S	\$178.00
PHBM812	12mm	H50	13.7mm	4.4mm	304 S/S	\$180.00
PHBM816	16mm	H50	13.7mm	4.4mm	304 S/S	\$183.10
PHBM820	20mm	H50	13.7mm	4.4mm	304 S/S	\$197.40
PHBM825	25mm	H50	13.7mm	4.4mm	304 S/S	\$215.90
PHBM830	30mm	H50	13.7mm	4.4mm	304 S/S	\$243.20
PHBM835	35mm	H50	13.7mm	4.4mm	304 S/S	\$276.00
PHBM840	40mm	H50	13.7mm	4.4mm	304 S/S	\$281.10
PHBM850	50mm	H50	13.7mm	4.4mm	304 S/S	\$316.20
PHBM860	60mm	H50	13.7mm	4.4mm	304 S/S	\$367.70

M10



● = 316 S/S

PART NO.	LENGTH	DRIVE SIZE	HEAD DIA	HEAD HEIGHT	MATERIAL	\$/100
PHBM1016	16mm	H60	17.4mm	5.5mm	304 S/S	\$228.00
PHBM1020	20mm	H60	17.4mm	5.5mm	304 S/S	\$232.70
PHBM1025	25mm	H60	17.4mm	5.5mm	304 S/S	\$255.40
PHBM1025-A4	25mm	H60	17.4mm	5.5mm	316 S/S	\$899.00
PHBM1030	30mm	H60	17.4mm	5.5mm	304 S/S	\$334.40
PHBM1040	40mm	H60	17.4mm	5.5mm	304 S/S	\$356.30
PHBM1050	50mm	H60	17.4mm	5.5mm	304 S/S	\$398.60
PHBM1060	60mm	H60	17.4mm	5.5mm	304 S/S	\$427.90
PHBM10100	100mm	H60	17.4mm	5.5mm	304 S/S	\$506.80

PIN HEX BUTTON HEAD MACHINE SCREWS

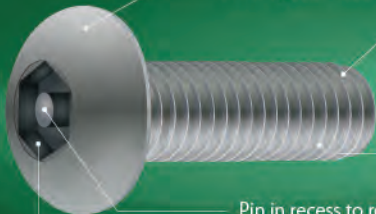

Domed button head shape has excellent visual effect and safety benefits. Other special head shapes can be custom manufactured to order.

Stocked in 304 Stainless steel with selected sizes available in 316 Stainless steel. Zinc and Galvanised versions can be made to order.

Imperial threads available see page 58

Pin in recess to resist tampering.

High torque hex drive with chamfer to assist driver tool insertion.

LEVEL 1:
Basic Security



Can be installed and removed with the following tools:



Insert Bit



Key Wrench

See page 137 - For more details on Driver Tools

M12



PART NO.	LENGTH	DRIVE SIZE	HEAD DIA	HEAD HEIGHT	MATERIAL	\$/100
PHBM1220	20mm	H80	23.6mm	7.5mm	304 S/S	\$1,096.80
PHBM1225	25mm	H80	23.6mm	7.5mm	304 S/S	\$1,114.90
PHBM1230	30mm	H80	23.6mm	7.5mm	304 S/S	\$1,133.40
PHBM1235	35mm	H80	23.6mm	7.5mm	304 S/S	\$1,160.00
PHBM1240	40mm	H80	23.6mm	7.5mm	304 S/S	\$1,192.40
PHBM1250	50mm	H80	23.6mm	7.5mm	304 S/S	\$1,240.60
PHBM1260	60mm	H80	23.6mm	7.5mm	304 S/S	\$1,446.00
PHBM12100	100mm	H80	23.6mm	7.5mm	304 S/S	\$2,250.00



PIN HEX IMPERIAL BUTTON HEAD MACHINE SCREWS

Domed button head shape has excellent visual effect and safety benefits. Other special head shapes can be custom manufactured to order.

Stocked in 304 Stainless steel. 316 Stainless steel, Zinc and Galvanised versions can be made to order.

Metric threads available see pages 52-57

Pin in recess to resist tampering.

High torque hex drive with chamfer to assist driver tool insertion.

LEVEL 1:
Basic Security

Can be installed and removed with the following tools:

Insert Bit

Key Wrench

See page 137 - For more details on Driver Tools

6-32 UNC

PART NO.	LENGTH	DRIVE SIZE	HEAD DIA	HEAD HEIGHT	MATERIAL	\$/100
PHBM632A	1/4" (7mm)	H30	6.6mm	2mm	304 S/S	\$88.00
PHBM632C	3/8" (9.5mm)	H30	6.6mm	2mm	304 S/S	\$89.00
PHBM632D	1/2" (13mm)	H30	6.6mm	2mm	304 S/S	\$91.00
PHBM632F	3/4" (19mm)	H30	6.6mm	2mm	304 S/S	\$93.00
PHBM632G	1" (25mm)	H30	6.6mm	2mm	304 S/S	\$95.00
PHBM632I	1 1/2" (38mm)	H30	6.6mm	2mm	304 S/S	\$112.00
PHBM632J	2" (50mm)	H25M	6.6mm	2mm	304 S/S	\$240.00

8-32 UNC

We can supply broken packs; just add 20% to the price.

PART NO.	LENGTH	DRIVE SIZE	HEAD DIA	HEAD HEIGHT	MATERIAL	\$/100
PHBM832A	1/4" (7mm)	H40	7.7mm	2.2mm	304 S/S	\$89.00
PHBM832C	3/8" (9.5mm)	H40	7.7mm	2.2mm	304 S/S	\$92.00
PHBM832D	1/2" (13mm)	H40	7.7mm	2.2mm	304 S/S	\$92.00
PHBM832F	3/4" (19mm)	H40	7.7mm	2.2mm	304 S/S	\$94.00
PHBM832G	1" (25mm)	H40	7.7mm	2.2mm	304 S/S	\$95.00
PHBM832I	1 1/2" (38mm)	H40	7.7mm	2.2mm	304 S/S	\$112.00

PIN HEX IMPERIAL BUTTON HEAD MACHINE SCREWS

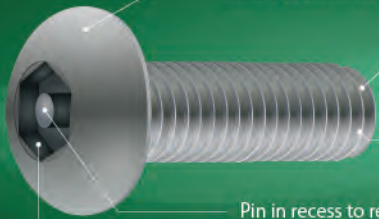

Domed button head shape has excellent visual effect and safety benefits. Other special head shapes can be custom manufactured to order.

Stocked in 304 Stainless steel. 316 Stainless steel, Zinc and Galvanised versions can be made to order.

Metric threads available see pages 52-57

Pin in recess to resist tampering.

High torque hex drive with chamfer to assist driver tool insertion.

LEVEL 1:
Basic Security



Can be installed and removed with the following tools:



Insert Bit



Key Wrench

See page 137 - For more details on Driver Tools

10-24 UNC



PART NO.	LENGTH	DRIVE SIZE	HEAD DIA	HEAD HEIGHT	MATERIAL	\$/100
PHBM1024A	1/4" (7mm)	H40	9mm	2.6mm	304 S/S	\$91.00
PHBM1024D	1/2" (13mm)	H40	9mm	2.6mm	304 S/S	\$94.00
PHBM1024F	3/4" (19mm)	H40	9mm	2.6mm	304 S/S	\$95.00
PHBM1024G	1" (25mm)	H40	9mm	2.6mm	304 S/S	\$96.00

10-32 UNF



PART NO.	LENGTH	DRIVE SIZE	HEAD DIA	HEAD HEIGHT	MATERIAL	\$/100
PHBM1032E	5/8" (16mm)	H40	9mm	2.6mm	304 S/S	\$95.00
PHBM1032F	3/4" (19mm)	H40	9mm	2.6mm	304 S/S	\$95.00
PHBM1032G	1" (25mm)	H40	9mm	2.6mm	304 S/S	\$96.00
PHBM1032H	1 1/4" (32mm)	H40	9mm	2.6mm	304 S/S	\$112.00
PHBM1032I	1 1/2" (38mm)	H40	9mm	2.6mm	304 S/S	\$115.00



PIN HEX IMPERIAL BUTTON HEAD MACHINE SCREWS

Domed button head shape has excellent visual effect and safety benefits. Other special head shapes can be custom manufactured to order.

Stocked in 304 Stainless steel. 316 Stainless steel, Zinc and Galvanised versions can be made to order.

Metric threads available see pages 52-57

Pin in recess to resist tampering.

High torque hex drive with chamfer to assist driver tool insertion.

LEVEL 1:
Basic Security

Can be installed and removed with the following tools:



Insert Bit



Key Wrench

See page 137 - For more details on Driver Tools

1/4-20 UNC



PART NO.	LENGTH	DRIVE SIZE	HEAD DIA	HEAD HEIGHT	MATERIAL	\$/100
PHBM1/4D	1/2" (13mm)	H40	10.9mm	3.5mm	304 S/S	\$160.00
PHBM1/4E	5/8" (16mm)	H40	10.9mm	3.5mm	304 S/S	\$116.00
PHBM1/4F	3/4" (19mm)	H40	10.9mm	3.5mm	304 S/S	\$118.00
PHBM1/4G	1" (25mm)	H40	10.9mm	3.5mm	304 S/S	\$120.00
PHBM1/4I	1 1/2" (38mm)	H40	10.9mm	3.5mm	304 S/S	\$146.00
PHBM1/4J	2" (50mm)	H40	10.9mm	3.5mm	304 S/S	\$165.00
PHBM1/4K	2 1/2" (63mm)	H40	10.9mm	3.5mm	304 S/S	\$184.00
PHBM1/4N	4" (100mm)	H40	10.9mm	3.5mm	304 S/S	\$203.00

3/8-16 UNC



PART NO.	LENGTH	DRIVE SIZE	HEAD DIA	HEAD HEIGHT	MATERIAL	\$/100
PHBM3/8E	5/8" (16mm)	H7/32	16.5mm	5mm	304 S/S	\$429.00
PHBM3/8F	3/4" (19mm)	H7/32	16.5mm	5mm	304 S/S	\$750.00
PHBM3/8G	1" (25mm)	H7/32	16.5mm	5mm	304 S/S	\$833.80
PHBM3/8I	1 1/2" (38mm)	H7/32	16.5mm	5mm	304 S/S	\$644.00
PHBM3/8J	2" (50mm)	H7/32	16.5mm	5mm	304 S/S	\$702.00
PHBM3/8K	2 1/2" (63mm)	H7/32	16.5mm	5mm	304 S/S	\$811.00

PIN HEX RAISED COUNTERSUNK MACHINE SCREWS

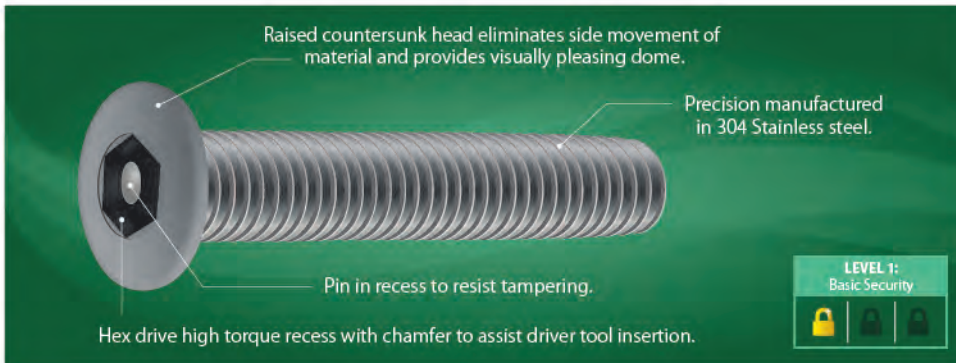

Can be installed and removed with the following tools:

- Insert Bit
- Key Wrench

See page 137 - For more details on Driver Tools



PART NO.	LENGTH	DRIVE SIZE	HEAD DIA	HEAD HEIGHT	MATERIAL	\$/100
PHOM3512	12mm	H30	6.4mm	1.8mm	304 S/S	\$297.20
PHOM3520	20mm	H30	6.4mm	1.8mm	304 S/S	\$300.20
PHOM3530	30mm	H30	6.4mm	1.8mm	304 S/S	\$317.60
PHOM3540	40mm	H30	6.4mm	1.8mm	304 S/S	\$326.60
PHOM3550	50mm	H30	6.4mm	1.8mm	304 S/S	\$347.40
PHOM3560	60mm	H30	6.4mm	1.8mm	304 S/S	\$368.40



PIN HEX COUNTERSUNK SELF TAPPING SCREWS

Countersunk head seats flush with material. Other special head shapes can be custom made to order.

Stocked in 304 Stainless steel. 316 Stainless steel, Zinc and Galvanised versions can be made to order.

Sharp needle point for accurate locating.

Sharp self-tapping threads suitable for screwing into a pre-drilled pilot hole.

Pin in recess to resist tampering.

High torque hex drive with chamfer to assist driver tool insertion.

LEVEL 1:
Basic Security

Can be installed and removed with the following tools:

Insert Bit

Key Wrench

See page 137 - For more details on Driver Tools



● = Metric Drive Recess

PART NO.	LENGTH	DRIVE SIZE	HEAD DIA	HEAD HEIGHT	MATERIAL	\$/100
PHCS6C	3/8" (9.5mm)	H30	6.6mm	2.5mm	304 S/S	\$82.10
PHCS6D	1/2" (13mm)	H30	6.6mm	2.5mm	304 S/S	\$85.10
PHCS6D-M	1/2" (13mm)	H2M	6.6mm	2.5mm	304 S/S	\$85.10 ●
PHCS6E	5/8" (16mm)	H30	6.6mm	2.5mm	304 S/S	\$87.80
PHCS6E-M	5/8" (16mm)	H2M	6.6mm	2.5mm	304 S/S	\$87.80 ●
PHCS6F	3/4" (19mm)	H30	6.6mm	2.5mm	304 S/S	\$90.20
PHCS6G	1" (25mm)	H30	6.6mm	2.5mm	304 S/S	\$98.20
PHCS6I	1 1/2" (38mm)	H30	6.6mm	2.5mm	304 S/S	\$121.30



PART NO.	LENGTH	DRIVE SIZE	HEAD DIA	HEAD HEIGHT	MATERIAL	\$/100
PHCS8D	1/2" (13mm)	H40	7.9mm	2.5mm	304 S/S	\$92.10
PHCS8E	5/8" (16mm)	H40	7.9mm	2.5mm	304 S/S	\$94.80
PHCS8F	3/4" (19mm)	H40	7.9mm	2.5mm	304 S/S	\$97.30
PHCS8G	1" (25mm)	H40	7.9mm	2.5mm	304 S/S	\$107.30
PHCS8H	1 1/4" (32mm)	H40	7.9mm	2.5mm	304 S/S	\$114.90
PHCS8I	1 1/2" (38mm)	H40	7.9mm	2.5mm	304 S/S	\$135.80
PHCS8J	2" (50mm)	H40	7.9mm	2.5mm	304 S/S	\$149.80

PIN HEX COUNTERSUNK SELF TAPPING SCREWS

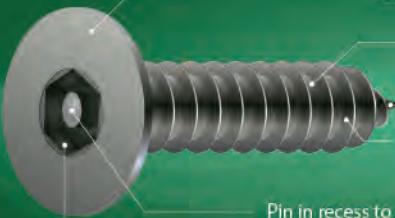

Countersunk head seats flush with material. Other special head shapes can be custom made to order.

Stocked in 304 Stainless steel. 316 Stainless steel, Zinc and Galvanised versions can be made to order.

Sharp needle point for accurate locating.

Sharp self-tapping threads suitable for screwing into a pre-drilled pilot hole.

Pin in recess to resist tampering.

High torque hex drive with chamfer to assist driver tool insertion.

LEVEL 1:
Basic Security



Can be installed and removed with the following tools:



Insert Bit



Key Wrench

See page 137 - For more details on Driver Tools

10G



PART NO.	LENGTH	DRIVE SIZE	HEAD DIA	HEAD HEIGHT	MATERIAL	\$/100
PHCS10D	1/2" (13mm)	H40	9.3mm	3mm	304 S/S	\$106.10
PHCS10E	5/8" (16mm)	H40	9.3mm	3mm	304 S/S	\$110.30
PHCS10F	3/4" (19mm)	H40	9.3mm	3mm	304 S/S	\$117.30
PHCS10G	1" (25mm)	H40	9.3mm	3mm	304 S/S	\$136.00
PHCS10H	1 1/4" (32mm)	H40	9.3mm	3mm	304 S/S	\$137.70
PHCS10I	1 1/2" (38mm)	H40	9.3mm	3mm	304 S/S	\$160.50
PHCS10J	2" (50mm)	H40	9.3mm	3mm	304 S/S	\$182.40
PHCS10K	2 1/2" (63mm)	H40	9.3mm	3mm	304 S/S	\$210.60

12G



We can supply broken packs; just add 20% to the price.

PART NO.	LENGTH	DRIVE SIZE	HEAD DIA	HEAD HEIGHT	MATERIAL	\$/100
PHCS12E	5/8" (16mm)	H40	11.7mm	4.8mm	304 S/S	\$156.60
PHCS12F	3/4" (19mm)	H40	11.7mm	4.8mm	304 S/S	\$159.00
PHCS12G	1" (25mm)	H40	11.7mm	4.8mm	304 S/S	\$163.80
PHCS12H	1 1/4" (32mm)	H40	11.7mm	4.8mm	304 S/S	\$166.00
PHCS12I	1 1/2" (38mm)	H40	11.7mm	4.8mm	304 S/S	\$221.60
PHCS12J	2" (50mm)	H40	11.7mm	4.8mm	304 S/S	\$253.00

PIN HEX COUNTERSUNK SELF TAPPING SCREWS

Countersunk head seats flush with material. Other special head shapes can be custom made to order.

Stocked in 304 Stainless steel. 316 Stainless steel, Zinc and Galvanised versions can be made to order.

Sharp needle point for accurate locating.

Sharp self-tapping threads suitable for screwing into a pre-drilled pilot hole.

Pin in recess to resist tampering.

High torque hex drive with chamfer to assist driver tool insertion.

LEVEL 1:
Basic Security

Can be installed and removed with the following tools:

Insert Bit

Key Wrench

See page 137 - For more details on Driver Tools



PART NO.	LENGTH	DRIVE SIZE	HEAD DIA	HEAD HEIGHT	MATERIAL	\$/100
PHCS14F	3/4" (19mm)	H40	12.8mm	5.2mm	304 S/S	\$205.00
PHCS14G	1" (25mm)	H40	12.8mm	5.2mm	304 S/S	\$256.00
PHCS14H	1 1/4" (32mm)	H40	12.8mm	5.2mm	304 S/S	\$283.60
PHCS14I	1 1/2" (38mm)	H40	12.8mm	5.2mm	304 S/S	\$342.00
PHCS14J	2" (50mm)	H40	12.8mm	5.2mm	304 S/S	\$387.00



PIN HEX BUTTON HEAD SELF TAPPING SCREWS

Domed button head shape has excellent visual effect and safety benefits. Other special head shapes can be custom manufactured to suit specific projects.

Sharp threaded taper point for accurate locating.

Sharp self tapping suitable for screwing into a pre-drilled pilot hole.

Pin in recess to resist tampering.

High torque hex drive with chamfer to assist driver tool insertion.

LEVEL 1:
Basic Security

Can be installed and removed with the following tools:

Insert Bit

Key Wrench

See page 137 - For more details on Driver Tools



● = Metric Drive Recess

PART NO.	LENGTH	DRIVE SIZE	HEAD DIA	HEAD HEIGHT	MATERIAL	\$/100
PHBS6C	3/8" (9.5mm)	H30	6.7mm	2.5mm	304 S/S	\$82.10
PHBS6D	1/2" (13mm)	H30	6.7mm	2.5mm	304 S/S	\$85.10
PHBS6D-M	1/2" (13mm)	H2M	6.7mm	2.5mm	304 S/S	\$85.10 ●
PHBS6E	5/8" (16mm)	H30	6.7mm	2.5mm	304 S/S	\$87.80
PHBS6F	3/4" (19mm)	H30	6.7mm	2.5mm	304 S/S	\$90.20
PHBS6G	1" (25mm)	H30	6.7mm	2.5mm	304 S/S	\$108.00
PHBS6I	1 1/2" (38mm)	H30	6.7mm	2.5mm	304 S/S	\$121.30



PART NO.	LENGTH	DRIVE SIZE	HEAD DIA	HEAD HEIGHT	MATERIAL	\$/100
PHBS8C	3/8" (9.5mm)	H40	7.4mm	2.1mm	304 S/S	\$100.20
PHBS8C-M	3/8" (9.5mm)	H25M	7.4mm	2.1mm	304 S/S	\$100.20 ●
PHBS8D	1/2" (13mm)	H40	7.4mm	2.1mm	304 S/S	\$103.60
PHBS8D-M	1/2" (13mm)	H25M	7.4mm	2.1mm	304 S/S	\$103.60 ●
PHBS8E	5/8" (16mm)	H40	7.4mm	2.1mm	304 S/S	\$106.70
PHBS8F	3/4" (19mm)	H40	7.4mm	2.1mm	304 S/S	\$109.40
PHBS8F-M	3/4" (19mm)	H25M	7.4mm	2.1mm	304 S/S	\$109.40 ●
PHBS8G	1" (25mm)	H40	7.4mm	2.1mm	304 S/S	\$120.70
PHBS8H	1 1/4" (32mm)	H40	7.4mm	2.1mm	304 S/S	\$129.20
PHBS8I	1 1/2" (38mm)	H40	7.4mm	2.1mm	304 S/S	\$152.80
PHBS8J	2" (50mm)	H40	7.4mm	2.1mm	304 S/S	\$168.60

PIN HEX BUTTON HEAD SELF TAPPING SCREWS

Domed button head shape has excellent visual effect and safety benefits. Other special head shapes can be custom manufactured to suit specific projects.

Sharp threaded taper point for accurate locating.

Sharp self tapping suitable for screwing into a pre-drilled pilot hole.

Pin in recess to resist tampering.

High torque hex drive with chamfer to assist driver tool insertion.

LEVEL 1:
Basic Security

Can be installed and removed with the following tools:

Insert Bit

Key Wrench

See page 137 - For more details on Driver Tools



● = Metric Drive Recess

PART NO.	LENGTH	DRIVE SIZE	HEAD DIA	HEAD HEIGHT	MATERIAL	\$/100
PHBS10D	1/2" (13mm)	H40	9.3mm	2.6mm	304 S/S	\$119.30
PHBS10D-M	1/2" (13mm)	H3M	9.3mm	2.6mm	304 S/S	\$119.30
PHBS10E	5/8" (16mm)	H40	9.3mm	2.6mm	304 S/S	\$124.10
PHBS10F	3/4" (19mm)	H40	9.3mm	2.6mm	304 S/S	\$131.90
PHBS10G	1" (25mm)	H40	9.3mm	2.6mm	304 S/S	\$142.20
PHBS10H	1 1/4" (32mm)	H40	9.3mm	2.6mm	304 S/S	\$154.90
PHBS10H-M	1 1/4" (32mm)	H3M	9.3mm	2.6mm	304 S/S	\$154.90
PHBS10I	1 1/2" (38mm)	H40	9.3mm	2.6mm	304 S/S	\$180.50
PHBS10J	2" (50mm)	H40	9.3mm	2.6mm	304 S/S	\$205.20
PHBS10K	2 1/2" (63mm)	H40	9.3mm	2.6mm	304 S/S	\$237.00



PART NO.	LENGTH	DRIVE SIZE	HEAD DIA	HEAD HEIGHT	MATERIAL	\$/100
PHBS12E	5/8" (16mm)	H40	9.9mm	2.9mm	304 S/S	\$179.30
PHBS12F	3/4" (19mm)	H40	9.9mm	2.9mm	304 S/S	\$183.00
PHBS12G	1" (25mm)	H40	9.9mm	2.9mm	304 S/S	\$187.20
PHBS12H	1 1/4" (32mm)	H40	9.9mm	2.9mm	304 S/S	\$189.70
PHBS12I	1 1/2" (38mm)	H40	9.9mm	2.9mm	304 S/S	\$253.20
PHBS12J	2" (50mm)	H40	9.9mm	2.9mm	304 S/S	\$268.00

PIN HEX BUTTON HEAD SELF TAPPING SCREWS

Domed button head shape has excellent visual effect and safety benefits. Other special head shapes can be custom manufactured to suit specific projects.

Sharp threaded taper point for accurate locating.

Sharp self tapping suitable for screwing into a pre-drilled pilot hole.

Pin in recess to resist tampering.

High torque hex drive with chamfer to assist driver tool insertion.

LEVEL 1:
 Basic Security

Can be installed and removed with the following tools:

Insert Bit

Key Wrench

See page 137 - For more details on Driver Tools



PART NO.	LENGTH	DRIVE SIZE	HEAD DIA	HEAD HEIGHT	MATERIAL	\$/100
PHBS14E	5/8" (16mm)	H40	11mm	3.4mm	304 S/S	\$229.30
PHBS14F	3/4" (19mm)	H40	11mm	3.4mm	304 S/S	\$234.40
PHBS14G	1" (25mm)	H40	11mm	3.4mm	304 S/S	\$310.10
PHBS14H	1 1/4" (32mm)	H40	11mm	3.4mm	304 S/S	\$325.60
PHBS14I	1 1/2" (38mm)	H40	11mm	3.4mm	304 S/S	\$342.00
PHBS14J	2" (50mm)	H40	11mm	3.4mm	304 S/S	\$387.00



CLUTCH HEAD COUNTERSUNK SELF TAPPING SCREWS

Countersunk head seats flush with material.

Clutch Head screws only operate in a clockwise direction, ideal for permanent fixtures.

Self-tapping thread suitable for screwing into a pre-drilled pilot hole.

Stocked in 304 Stainless Steel. Zinc plated options can be made to order.

No special tool required for installation, One-way Clutch Head screws are installed with flat blade screw driver.

LEVEL 3:
Maximum Security

Can be installed and removed with the following tools:

- Flat Blade Insert Bit
- Screwdriver
- Removal Tool

See page 135 - For more details on Driver Tools

6G

PART NO.	LENGTH	DRIVE SIZE	REMOVAL TOOL	HEAD DIA	HEAD HEIGHT	MATERIAL	\$/100
CHCS6F	19mm	SLD5	RT41	6.8mm	3.2mm	304 S/S	\$35.00
CHCS6G	25mm	SLD5	RT41	6.8mm	3.2mm	304 S/S	\$49.70

8G

PART NO.	LENGTH	DRIVE SIZE	REMOVAL TOOL	HEAD DIA	HEAD HEIGHT	MATERIAL	\$/100
CHCS8D	13mm	SLD8	RT51	8.1mm	3.8mm	304 S/S	\$47.90
CHCS8F	19mm	SLD8	RT51	8.1mm	3.8mm	304 S/S	\$50.70
CHCS8G	25mm	SLD8	RT51	8.1mm	3.8mm	304 S/S	\$53.50
CHCS8H	32mm	SLD8	RT51	8.1mm	3.8mm	304 S/S	\$63.00
CHCS8I	38mm	SLD8	RT51	8.1mm	3.8mm	304 S/S	\$63.70
CHCS8J	50mm	SLD8	RT51	8.1mm	3.8mm	304 S/S	\$71.40

10G

PART NO.	LENGTH	DRIVE SIZE	REMOVAL TOOL	HEAD DIA	HEAD HEIGHT	MATERIAL	\$/100
CHCS10G	25mm	SLD8	RT51	9.4mm	4.4mm	304 S/S	\$65.10
CHCS10H	32mm	SLD8	RT51	9.4mm	4.4mm	304 S/S	\$67.90
CHCS10I	38mm	SLD8	RT51	9.4mm	4.4mm	304 S/S	\$85.40
CHCS10J	50mm	SLD8	RT51	9.4mm	4.4mm	304 S/S	\$121.10

CLUTCH HEAD COUNTERSUNK WOODSCREWS

Countersunk head seats flush with material.

Clutch Head screws only operate in a clockwise direction, ideal for permanent fixtures.

Coarse thread woodscrew designed for screwing into timber.

Stocked in zinc plated steel.

No special tool required for installation, One-way Clutch Head screws are installed with flat blade screw driver.

LEVEL 3:
Maximum Security

Can be installed and removed with the following tools:

- Flat Blade Insert Bit
- Screwdriver
- Removal Tool

See page 135 - For more details on Driver Tools



PART NO.	LENGTH	DRIVE SIZE	REMOVAL TOOL	HEAD DIA	HEAD HEIGHT	MATERIAL	\$/100
CHCW6F-Z	19mm	SLD5	RT41	7mm	3.5mm	Zinc Plated	\$23.30
CHCW6G-Z	25mm	SLD5	RT41	7mm	3.5mm	Zinc Plated	\$30.90



PART NO.	LENGTH	DRIVE SIZE	REMOVAL TOOL	HEAD DIA	HEAD HEIGHT	MATERIAL	\$/100
CHCW8F-Z	19mm	SLD8	RT51	8.3mm	4.6mm	Zinc Plated	\$28.30
CHCW8G-Z	25mm	SLD8	RT51	8.3mm	4.6mm	Zinc Plated	\$31.20
CHCW8H-Z	32mm	SLD8	RT51	8.3mm	4.6mm	Zinc Plated	\$32.40
CHCW8I-Z	38mm	SLD8	RT51	8.3mm	4.6mm	Zinc Plated	\$39.80
CHCW8J-Z	50mm	SLD8	RT51	8.3mm	4.6mm	Zinc Plated	\$40.90



CLUTCH HEAD COUNTERSUNK WOODSCREWS

Countersunk head seats flush with material.

Clutch Head screws only operate in a clockwise direction, ideal for permanent fixtures.

Coarse thread woodscrew designed for screwing into timber.

Stocked in zinc plated steel.

No special tool required for installation, One-way Clutch Head screws are installed with flat blade screw driver.

LEVEL 3:
Maximum Security

Can be installed and removed with the following tools:

- Flat Blade Insert Bit
- Screwdriver
- Removal Tool

See page 135 - For more details on Driver Tools

10G

PART NO.	LENGTH	DRIVE SIZE	REMOVAL TOOL	HEAD DIA	HEAD HEIGHT	MATERIAL	\$/100
CHCW10G-Z	25mm	SLD8	RT51	9.3mm	5mm	Zinc Plated	\$39.50
CHCW10H-Z	32mm	SLD8	RT51	9.3mm	5mm	Zinc Plated	\$44.20
CHCW10I-Z	38mm	SLD8	RT51	9.3mm	5mm	Zinc Plated	\$51.70
CHCW10J-Z	50mm	SLD8	RT51	9.3mm	5mm	Zinc Plated	\$62.50

12G

PART NO.	LENGTH	DRIVE SIZE	REMOVAL TOOL	HEAD DIA	HEAD HEIGHT	MATERIAL	\$/100
CHCW12I-Z	38mm	SLD10	RT51	11mm	5.4mm	Zinc Plated	\$65.90
CHCW12J-Z	50mm	SLD10	RT51	11mm	5.4mm	Zinc Plated	\$83.70
CHCW12K-Z	63mm	SLD10	RT51	11mm	5.4mm	Zinc Plated	\$97.80
CHCW12L-Z	75mm	SLD10	RT51	11mm	5.4mm	Zinc Plated	\$130.30



We can supply broken packs; just add 20% to the price.
Contact Our Sales Team To Find Out More

CLUTCH HEAD ROUND HEAD SELF TAPPING SCREWS

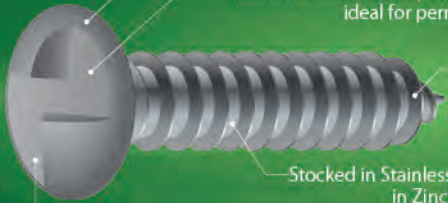

Raised head shape has excellent visual effect.

Clutch Head screws only operate in a clockwise direction, ideal for permanent fixtures.

Self-tapping thread suitable for screwing into a pre-drilled pilot hole.



Stocked in Stainless steel with selected sizes in Zinc Plated steel.

No special tool required for installation, One-way Clutch Head screws are installed with flat blade screw driver.

LEVEL 3:
Maximum Security



Can be installed and removed with the following tools:

 Flat Blade Insert Bit
  Screwdriver
  Removal Tool

See page 135 - For more details on Driver Tools



PART NO.	LENGTH	DRIVE SIZE	REMOVAL TOOL	HEAD DIA	HEAD HEIGHT	MATERIAL	\$/100
CHRS6D	13mm	SLD5	RT41	6.3mm	2.5mm	304 S/S	\$34.55
CHRS6F	19mm	SLD5	RT41	6.3mm	2.5mm	304 S/S	\$35.28
CHRS6G	25mm	SLD5	RT41	6.3mm	2.5mm	304 S/S	\$40.43



PART NO.	LENGTH	DRIVE SIZE	REMOVAL TOOL	HEAD DIA	HEAD HEIGHT	MATERIAL	\$/100
CHRS8D	13mm	SLD8	RT51	7.6mm	2.9mm	304 S/S	\$47.78
CHRS8F	19mm	SLD8	RT51	7.6mm	2.9mm	304 S/S	\$51.03
CHRS8G	25mm	SLD8	RT51	7.6mm	2.9mm	304 S/S	\$52.50
CHRS8H	32mm	SLD8	RT51	7.6mm	2.9mm	304 S/S	\$57.75
CHRS8I	38mm	SLD8	RT51	7.6mm	2.9mm	304 S/S	\$63.00
CHRS8J	50mm	SLD8	RT51	7.6mm	2.9mm	304 S/S	\$89.25



Ideal for securing number plates. Other sizes also available on pages 74, 75 & 76.

CLUTCH HEAD ROUND HEAD SELF TAPPING SCREWS

Level 3: Maximum Security

No special tool required for installation, One-way Clutch Head screws are installed with flat blade screw driver.

Can be installed and removed with the following tools:

- Flat Blade Insert Bit
- Screwdriver
- Removal Tool

See page 135 - For more details on Driver Tools



○ = Zinc Plated

PART NO.	LENGTH	DRIVE SIZE	REMOVAL TOOL	HEAD DIA	HEAD HEIGHT	MATERIAL	\$/100
CHRS10D	13mm	SLD8	RT51	8.8mm	3.4mm	304 S/S	\$58.59
CHRS10F	19mm	SLD8	RT51	8.8mm	3.4mm	304 S/S	\$62.69
CHRS10F-Z	19mm	SLD8	RT51	8.8mm	3.4mm	Zinc Plated	\$37.50 ○
CHRS10G	25mm	SLD8	RT51	8.8mm	3.4mm	304 S/S	\$75.39
CHRS10H	32mm	SLD8	RT51	8.8mm	3.4mm	304 S/S	\$76.65
CHRS10I	38mm	SLD8	RT51	8.8mm	3.4mm	304 S/S	\$80.33
CHRS10J	50mm	SLD8	RT51	8.8mm	3.4mm	304 S/S	\$84.53



PART NO.	LENGTH	DRIVE SIZE	REMOVAL TOOL	HEAD DIA	HEAD HEIGHT	MATERIAL	\$/100
CHRS12F-Z	19mm	SLD10	RT51	10mm	3.95mm	Zinc Plated	\$45.00 ○



PART NO.	LENGTH	DRIVE SIZE	REMOVAL TOOL	HEAD DIA	HEAD HEIGHT	MATERIAL	\$/100
CHRS14D	13mm	SLD10	RT61	11.7mm	4.4mm	304 S/S	\$71.93
CHRS14F	19mm	SLD10	RT61	11.7mm	4.4mm	304 S/S	\$97.13
CHRS14G	25mm	SLD10	RT61	11.7mm	4.4mm	304 S/S	\$135.03
CHRS14I	38mm	SLD10	RT61	11.7mm	4.4mm	304 S/S	\$135.77

CLUTCH HEAD ROUND HEAD MACHINE SCREWS

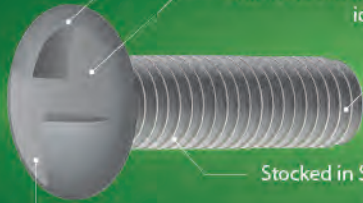

Raised head shape has excellent visual effect.

Clutch Head screws only operate in a clockwise direction, ideal for permanent fixtures.

Machine thread available in various sizes, Imperial sizes available by special order.

Stocked in Stainless steel with selected sizes in Zinc Plated steel.

No special tool required for installation, One-way Clutch Head screws are installed with flat blade screw driver.

LEVEL 3:
 Maximum Security

Can be installed and removed with the following tools:

-  Flat Blade Insert Bit
-  Screwdriver
-  Removal Tool

See page 135 - For more details on Driver Tools



○ = Zinc Plated

PART NO.	LENGTH	DRIVE SIZE	REMOVAL TOOL	HEAD DIA	HEAD HEIGHT	MATERIAL	\$/100
CHRM408	8mm	SLD5	RT41	7.4mm	2.8mm	304 S/S	\$70.00
CHRM410	10mm	SLD5	RT41	7.4mm	2.8mm	304 S/S	\$72.00
CHRM412	12mm	SLD5	RT41	7.4mm	2.8mm	304 S/S	\$72.00
CHRM416	16mm	SLD5	RT41	7.4mm	2.8mm	304 S/S	\$76.00
CHRM420	20mm	SLD5	RT41	7.4mm	2.8mm	304 S/S	\$81.00
CHRM425	25mm	SLD5	RT41	7.4mm	2.8mm	304 S/S	\$86.00
CHRM430	30mm	SLD5	RT41	7.4mm	2.8mm	304 S/S	\$105.00
CHRM440	40mm	SLD5	RT41	7.4mm	2.8mm	304 S/S	\$134.00



PART NO.	LENGTH	DRIVE SIZE	REMOVAL TOOL	HEAD DIA	HEAD HEIGHT	MATERIAL	\$/100
CHRM510	10mm	SLD8	RT51	9.3mm	3.2mm	304 S/S	\$98.00
CHRM512	12mm	SLD8	RT51	9.3mm	3.2mm	304 S/S	\$99.00
CHRM516	16mm	SLD8	RT51	9.3mm	3.2mm	304 S/S	\$100.00
CHRM520	20mm	SLD8	RT51	9.3mm	3.2mm	304 S/S	\$106.00
CHRM520-Z	20mm	SLD8	RT51	9.3mm	3.2mm	Zinc Plated	\$37.50 ○
CHRM525	25mm	SLD8	RT51	9.3mm	3.2mm	304 S/S	\$118.00
CHRM530	30mm	SLD8	RT51	9.3mm	3.2mm	304 S/S	\$126.00
CHRM540	40mm	SLD8	RT51	9.3mm	3.2mm	304 S/S	\$148.00

CLUTCH HEAD ROUND HEAD MACHINE SCREWS

Raised head shape has excellent visual effect.

Clutch Head screws only operate in a clockwise direction, ideal for permanent fixtures.

Machine thread available in various sizes, Imperial sizes available by special order.

Stocked in Stainless steel with selected sizes in Zinc Plated steel.

No special tool required for installation, One-way Clutch Head screws are installed with flat blade screw driver.

LEVEL 3:
Maximum Security

Can be installed and removed with the following tools:

- Flat Blade Insert Bit
- Screwdriver
- Removal Tool

See page 135 - For more details on Driver Tools



○ = Zinc Plated

PART NO.	LENGTH	DRIVE SIZE	REMOVAL TOOL	HEAD DIA	HEAD HEIGHT	MATERIAL	\$/100
CHRM620	20mm	SLD10	RT61	10.2mm	3.5mm	304 S/S	\$112.00
CHRM620-Z	20mm	SLD10	RT61	10.2mm	3.5mm	Zinc Plated	\$45.00 ○
CHRM625	25mm	SLD10	RT61	10.2mm	3.5mm	304 S/S	\$130.00
CHRM630	30mm	SLD10	RT61	10.2mm	3.5mm	304 S/S	\$138.00
CHRM640	40mm	SLD10	RT61	10.2mm	3.5mm	304 S/S	\$161.00
CHRM650	50mm	SLD10	RT61	10.2mm	3.5mm	304 S/S	\$180.00



CLUTCH HEAD SHOULDER SCREWS AND BARREL NUTS

Matching head diameter for neat finish.

Clutch head screws only operate in a clockwise direction, ideal for permanent fixtures.

Stocked in Chrome Plated finish. Refer to pages 33-37 for options in Stainless steel.

No special tools required for installation, uses standard flat blade screwdriver.

LEVEL 3:
Maximum Security

Can be installed and removed with the following tools:

- Flat Blade Insert Bit
- Screwdriver
- Removal Tool

See page 135 - For more details on Driver Tools

10-24 UNC Shoulder Screws

PART NO.	LENGTH	DRIVE SIZE	REMOVAL TOOL	HEAD DIA	HEAD HEIGHT	MATERIAL	\$/100
CHSS1019	19mm	SLD8	RT51	10.95mm	3.2mm	Chrome Plated	\$226.20
CHSS1024	23.4mm	SLD8	RT51	10.95mm	3.2mm	Chrome Plated	\$211.20
CHSS1027	26.1mm	SLD8	RT51	10.95mm	3.2mm	Chrome Plated	\$253.00
CHSS1030	30mm	SLD8	RT51	10.95mm	3.2mm	Chrome Plated	\$309.30
CHSS1033	33mm	SLD8	RT51	10.95mm	3.2mm	Chrome Plated	\$314.60

10-24 UNC Barrel Nuts

PART NO.	LENGTH	DRIVE SIZE	REMOVAL TOOL	HEAD DIA	HEAD HEIGHT	MATERIAL	\$/100
CHBN10D	13mm	SLD8	RT51	10.95mm	2.9mm	Chrome Plated	\$250.30
CHBN10E	16mm	SLD8	RT51	10.95mm	2.9mm	Chrome Plated	\$254.80

DIMENSIONS

LENGTH / DIMENSIONS	13mm 1/2"	16mm 5/8"	3/4"	15/16"	1 1/16"	1 3/16"	1 5/16"
Dimension A			18.7mm 0.74"	23.4mm 0.92"	26.1mm 1.03"	30mm 1.18"	33mm 1.30"
Dimension B			6.8mm 0.27"	4.8mm 0.19"	6.6mm 0.26"	6.6mm 0.26"	6.7mm 0.26"
Dimension C	12.6mm 0.50"	15.9mm 0.63"					

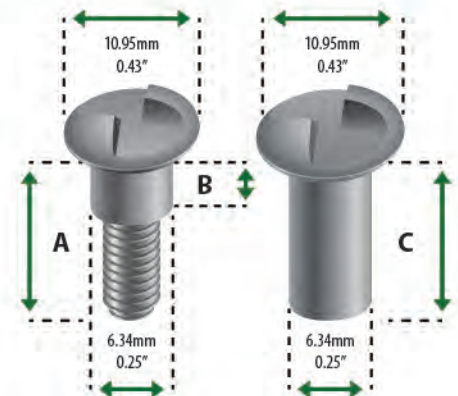

SENTINEL COUNTERSUNK MACHINE SCREWS



One way clutch type drive recess allows easy installation with standard Pozi Driver but almost impossible to remove.

Manufactured with zinc plated finish, galvanised to order.

Countersunk head seats flush with material.

Drive shape is unique to Prolok, Design rights apply.

LEVEL 3:
Maximum Security



**Installed with standard tools
no tool for removal**



Pozi Drive Insert Bit



Pozi Drive Screwdriver

M4

PART NO.	LENGTH	DRIVE SIZE	HEAD DIA	HEAD HEIGHT	MATERIAL	\$/100
STCM412	12mm	PZ2	7.2mm	2.7mm	Clear Zinc Plated	\$118.25
STCM416	16mm	PZ2	7.2mm	2.7mm	Clear Zinc Plated	\$119.35
STCM420	20mm	PZ2	7.2mm	2.7mm	Clear Zinc Plated	\$120.45
STCM425	25mm	PZ2	7.2mm	2.7mm	Clear Zinc Plated	\$121.00
STCM430	30mm	PZ2	7.2mm	2.7mm	Clear Zinc Plated	\$122.65

M5

PART NO.	LENGTH	DRIVE SIZE	HEAD DIA	HEAD HEIGHT	MATERIAL	\$/100
STCM512	12mm	PZ2	8.9mm	3.0mm	Clear Zinc Plated	\$120.45
STCM520	20mm	PZ2	8.9mm	3.0mm	Clear Zinc Plated	\$123.75
STCM525	25mm	PZ2	8.9mm	3.0mm	Clear Zinc Plated	\$125.95
STCM530	30mm	PZ2	8.9mm	3.0mm	Clear Zinc Plated	\$131.45
STCM540	40mm	PZ2	8.9mm	3.0mm	Clear Zinc Plated	\$286.00

M6

PART NO.	LENGTH	DRIVE SIZE	HEAD DIA	HEAD HEIGHT	MATERIAL	\$/100
STCM612	12mm	PZ3	10.8mm	3.6mm	Clear Zinc Plated	\$121.00
STCM616	16mm	PZ3	10.8mm	3.6mm	Clear Zinc Plated	\$123.20
STCM620	20mm	PZ3	10.8mm	3.6mm	Clear Zinc Plated	\$125.40
STCM625	25mm	PZ3	10.8mm	3.6mm	Clear Zinc Plated	\$128.15
STCM630	30mm	PZ3	10.8mm	3.6mm	Clear Zinc Plated	\$130.90
STCM640	40mm	PZ3	10.8mm	3.6mm	Clear Zinc Plated	\$300.30

SENTINEL PAN HEAD MACHINE SCREWS

One way clutch type drive recess allows easy installation with standard Pozzi Driver but almost impossible to remove.

Manufactured with zinc plated finish, galvanised to order.

Pan head head shape has excellent visual effect and safety benefits.

Drive shape is unique to Prolok, Design rights apply.

LEVEL 3;
Maximum Security

**Installed with standard tools
no tool for removal**

Pozzi Drive Insert Bit

Pozzi Drive Screwdriver



PART NO.	LENGTH	DRIVE SIZE	HEAD DIA	HEAD HEIGHT	MATERIAL	\$/100
STBM412	12mm	PZ2	7.7mm	2.8mm	Clear Zinc Plated	\$118.25
STBM416	16mm	PZ2	7.7mm	2.8mm	Clear Zinc Plated	\$119.35
STBM420	20mm	PZ2	7.7mm	2.8mm	Clear Zinc Plated	\$120.45
STBM425	25mm	PZ2	7.7mm	2.8mm	Clear Zinc Plated	\$121.00
STBM430	30mm	PZ2	7.7mm	2.8mm	Clear Zinc Plated	\$122.65



*We can supply broken packs;
just add 20% to the price.*

PART NO.	LENGTH	DRIVE SIZE	HEAD DIA	HEAD HEIGHT	MATERIAL	\$/100
STBM512	12mm	PZ2	9.8mm	3.5mm	Clear Zinc Plated	\$120.45
STBM516	16mm	PZ2	9.8mm	3.5mm	Clear Zinc Plated	\$122.10
STBM520	20mm	PZ2	9.8mm	3.5mm	Clear Zinc Plated	\$123.75
STBM525	25mm	PZ2	9.8mm	3.5mm	Clear Zinc Plated	\$125.95
STBM530	30mm	PZ2	9.8mm	3.5mm	Clear Zinc Plated	\$131.45
STBM540	40mm	PZ2	9.8mm	3.5mm	Clear Zinc Plated	\$286.00

SENTINEL PAN HEAD MACHINE SCREWS

One way clutch type drive recess allows easy installation with standard Pozzi Driver but almost impossible to remove.

Manufactured with zinc plated finish, galvanised to order.

Pan head head shape has excellent visual effect and safety benefits.

Drive shape is unique to Prolok, Design rights apply.

LEVEL 3:
Maximum Security

**Installed with standard tools
no tool for removal**

Pozzi Drive Insert Bit

Pozzi Drive Screwdriver

M6

PART NO.	LENGTH	DRIVE SIZE	HEAD DIA	HEAD HEIGHT	MATERIAL	\$/100
STBM612	12mm	PZ3	11.6mm	4.2mm	Clear Zinc Plated	\$121.00
STBM616	16mm	PZ3	11.6mm	4.2mm	Clear Zinc Plated	\$123.20
STBM620	20mm	PZ3	11.6mm	4.2mm	Clear Zinc Plated	\$125.40
STBM625	25mm	PZ3	11.6mm	4.2mm	Clear Zinc Plated	\$128.15
STBM640	40mm	PZ3	11.6mm	4.2mm	Clear Zinc Plated	\$300.30

M8

PART NO.	LENGTH	DRIVE SIZE	HEAD DIA	HEAD HEIGHT	MATERIAL	\$/100
STBM825	25mm	PZ4	15.8mm	5.5mm	Clear Zinc Plated	\$152.90
STBM830	30mm	PZ4	15.8mm	5.5mm	Clear Zinc Plated	\$157.30
STBM840	40mm	PZ4	15.8mm	5.5mm	Clear Zinc Plated	\$162.80
STBM850	50mm	PZ4	15.8mm	5.5mm	Clear Zinc Plated	\$169.40

card to
below

Fast & easy installation, ideal for permanent, non-removable fixings.

SENTINEL THREADFORMING MACHINE SCREW

One way clutch type drive recess allows easy installation with standard Pozidriver but almost impossible to remove.

Hardened steel with galvanised finish.

Taper point facilitates entry and thread forming.

Domed button head shape has excellent visual effect and safety benefits.

Drive shape is unique to Prolok, Design rights apply.

LEVEL 3:
Maximum Security

**Installed with standard tools
no tool for removal**

Pozidriver Insert Bit

Pozidriver Screwdriver



Also available in Resytork style, contact our sales team for more details.

PART NO.	LENGTH	DRIVE SIZE	HEAD DIA	HEAD HEIGHT	MATERIAL	\$/100
STMM820	20mm	PZ4	17mm	5.65mm	Galvanised	\$160.00
STMM835	35mm	PZ4	17mm	5.65mm	Galvanised	\$188.00

Recommended Pilot Hole Size for Metric Taptite screws

For various material thickness expressed in screw diameters

APPLICATION DUTY CLASS	LIGHT 0.3mm DIAMETER OF MATERIAL			MEDIUM - LIGHT 0.5 DIAMETER OF MATERIAL			MEDIUM - HEAVY 0.75 DIAMETER OF MATERIAL		
PERCENT OF THREAD	90% (1)			85% (1)			80%		
NOMINAL SIZE & PITCH	MATERIAL THICKNESS RANGE mm	PILOT HOLE mm	NEAREST DRILL SIZE mm	MATERIAL THICKNESS RANGE mm	PILOT HOLE mm	NEAREST DRILL SIZE mm	MATERIAL THICKNESS RANGE mm	PILOT HOLE mm	NEAREST DRILL SIZE mm
M8 x 1.25	1.6 TO 3.1	7.27	7.25	3.1 TO 4.9	7.31	7.3	4.9 TO 6.9	7.35	"L" 7.37

APPLICATION DUTY CLASS	FULL STRENGTH 1.0 DIAMETER			EXTENDED 1.25 DIAMETER OF MATERIAL		
PERCENT OF THREAD	75%			70%		
NOMINAL SIZE & PITCH	MATERIAL THICKNESS RANGE mm	PILOT HOLE mm	NEAREST DRILL SIZE mm	MATERIAL THICKNESS RANGE mm	PILOT HOLE mm	NEAREST DRILL SIZE mm
M8 x 1.25	6.9 TO 8.9	7.39	"L" 7.4	8.9 TO 10.9	7.43	7.4

SENTINEL COUNTERSUNK WOOD SCREWS

One way clutch type drive recess allows easy installation with standard Pozi Driver but almost impossible to remove.

Coarse woodscrew thread precision manufactured with zincplated finish, galvanised to order.

Sharp threaded taper point for accurate locating.

Countersunk head seats flush with material.

Drive shape is unique to Prolok, Design rights apply.

LEVEL 3:
Maximum Security

**Installed with standard tools
no tool for removal**

Pozi Drive Insert Bit

Pozi Drive Screwdriver

6G

PART NO.	LENGTH	DRIVE SIZE	HEAD DIA	HEAD HEIGHT	MATERIAL	\$/200	\$/1000
STCW6F	19mm	PZ2	6.8mm	2.5mm	Clear Zinc Plated	\$61.99	\$281.78
STCW6G	25mm	PZ2	6.8mm	2.5mm	Clear Zinc Plated	\$66.83	\$303.75

8G

*We can supply broken packs;
just add 20% to the price.*

PART NO.	LENGTH	DRIVE SIZE	HEAD DIA	HEAD HEIGHT	MATERIAL	\$/200	\$/1000
STCW8F	19mm	PZ2	8.4mm	2.5mm	Clear Zinc Plated	\$75.83	\$344.70
STCW8G	25mm	PZ2	7.9mm	2.5mm	Clear Zinc Plated	\$88.05	\$400.24
STCW8H	32mm	PZ2	7.9mm	2.5mm	Clear Zinc Plated	\$101.40	\$460.93
STCW8I	38mm	PZ2	7.9mm	2.5mm	Clear Zinc Plated	\$115.67	\$525.77
STCW8J	50mm	PZ2	7.9mm	2.5mm	Clear Zinc Plated	\$135.03	\$613.76



SENTINEL COUNTERSUNK WOOD SCREWS

One way clutch type drive recess allows easy installation with standard Pozzi Driver but almost impossible to remove.

Coarse woodscrew thread precision manufactured with zincplated finish, galvanised to order.

Sharp threaded taper point for accurate locating.

Countersunk head seats flush with material.

Drive shape is unique to Prolok, Design rights apply.

LEVEL 3:
Maximum Security

**Installed with standard tools
no tool for removal**

Pozzi Drive Insert Bit

Pozzi Drive Screwdriver



PART NO.	LENGTH	DRIVE SIZE	HEAD DIA	HEAD HEIGHT	MATERIAL	\$/200	\$/1000
STCW10G	25mm	PZ2	9.8mm	3.5mm	Clear Zinc Plated	\$145.38	\$660.81
STCW10H	32mm	PZ2	9.8mm	3.5mm	Clear Zinc Plated	\$151.44	\$688.35
STCW10I	38mm	PZ2	9.8mm	3.5mm	Clear Zinc Plated	\$167.10	\$759.53
STCW10J	50mm	PZ2	9.8mm	3.5mm	Clear Zinc Plated	\$177.12	\$805.11



*We can supply broken packs;
just add 20% to the price.*

PART NO.	LENGTH	DRIVE SIZE	HEAD DIA	HEAD HEIGHT	MATERIAL	\$/200	\$/1000
STCW12I	38mm	PZ3	11.7mm	4.2mm	Clear Zinc Plated	\$198.52	\$902.36
STCW12J	50mm	PZ3	11.7mm	4.2mm	Clear Zinc Plated	\$268.29	\$1,219.48
STCW12K	63mm	PZ3	11.7mm	4.2mm	Clear Zinc Plated	\$333.44	\$1,515.64
STCW12L	75mm	PZ3	11.7mm	4.2mm	Clear Zinc Plated	\$369.48	\$1,679.44



2 HOLE COUNTERSUNK MACHINE SCREWS

Countersunk head seats flush with material.

Imperial thread sizes also available by special order.

2 hole driver system is tamper resistant and also popular for visual effect.

Stocked in 304 Stainless steel. 316 Stainless steel, Zinc and Galvanised versions can be made to order.

LEVEL 1:
Basic Security

Can be installed and removed with the following tools:

Insert Bit

See page 137 - For more details on Driver Tools



Imperial thread sizes 6-32, 8-32, 10-24, 10-32 and 1/4UNC also available. Contact our sales team for pricing

PART NO.	LENGTH	DRIVE SIZE	HEAD DIA	HEAD HEIGHT	MATERIAL	\$/100
THCM308	8mm	TH3	5.5mm	1.6mm	304 S/S	\$107.10
THCM310	10mm	TH3	5.5mm	1.6mm	304 S/S	\$110.00
THCM312	12mm	TH3	5.5mm	1.6mm	304 S/S	\$111.30
THCM316	16mm	TH3	5.5mm	1.6mm	304 S/S	\$113.20
THCM320	20mm	TH3	5.5mm	1.6mm	304 S/S	\$117.60
THCM325	25mm	TH3	5.5mm	1.6mm	304 S/S	\$120.80
THCM330	30mm	TH3	5.5mm	1.6mm	304 S/S	\$130.80
THCM335	35mm	TH3	5.5mm	1.6mm	304 S/S	\$138.60



PART NO.	LENGTH	DRIVE SIZE	HEAD DIA	HEAD HEIGHT	MATERIAL	\$/100
THCM410	10mm	TH5	7.4mm	2.4mm	304 S/S	\$115.90
THCM412	12mm	TH5	7.4mm	2.4mm	304 S/S	\$117.20
THCM416	16mm	TH5	7.4mm	2.4mm	304 S/S	\$119.20
THCM420	20mm	TH5	7.4mm	2.4mm	304 S/S	\$120.70
THCM425	25mm	TH5	7.4mm	2.4mm	304 S/S	\$125.70
THCM430	30mm	TH5	7.4mm	2.4mm	304 S/S	\$124.40
THCM435	35mm	TH5	7.4mm	2.4mm	304 S/S	\$137.60

2 HOLE COUNTERSUNK MACHINE SCREWS



Countersunk head seats flush with material.

Stocked in 304 Stainless steel. 316 Stainless steel, Zinc and Galvanised versions can be made to order.

Imperial thread sizes also available by special order.

2 hole driver system is tamper resistant and also popular for visual effect.

LEVEL 1:
Basic Security



Can be installed and removed with the following tools:



Insert Bit

See page 137 - For more details on Driver Tools



PART NO.	LENGTH	DRIVE SIZE	HEAD DIA	HEAD HEIGHT	MATERIAL	\$/100
THCM512	12mm	TH6	9.0mm	2.9mm	304 S/S	\$117.80
THCM516	16mm	TH6	9.0mm	2.9mm	304 S/S	\$119.00
THCM520	20mm	TH6	9.0mm	2.9mm	304 S/S	\$124.40
THCM525	25mm	TH6	9.0mm	2.9mm	304 S/S	\$131.20
THCM530	30mm	TH6	9.0mm	2.9mm	304 S/S	\$141.90
THCM535	35mm	TH6	9.0mm	2.9mm	304 S/S	\$150.00



We can supply broken packs just add 20%.

PART NO.	LENGTH	DRIVE SIZE	HEAD DIA	HEAD HEIGHT	MATERIAL	\$/100
THCM612	12mm	TH8	10.8mm	3.5mm	304 S/S	\$143.40
THCM616	16mm	TH8	10.8mm	3.5mm	304 S/S	\$152.20
THCM620	20mm	TH8	10.8mm	3.5mm	304 S/S	\$161.40
THCM625	25mm	TH8	10.8mm	3.5mm	304 S/S	\$164.00
THCM630	30mm	TH8	10.8mm	3.5mm	304 S/S	\$175.10
THCM640	40mm	TH8	10.8mm	3.5mm	304 S/S	\$211.80



**TWO HOLE NUTS ALSO AVAILABLE,
CONTACT OUR SALES TEAM FOR SIZES AND PRICING.**

2 HOLE PAN HEAD MACHINE SCREWS

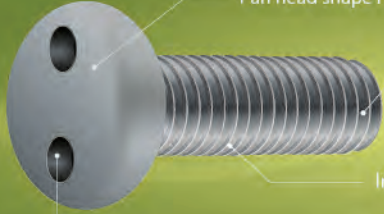

Pan head shape has excellent visual effect and safety benefits.

Stocked in 304 Stainless steel, 316 Stainless steel, Zinc and Galvanised versions can be made to order.

Imperial thread sizes also available by special order.

2 hole driver system is tamper resistant and also popular for visual effect.

LEVEL 1:
Basic Security



Can be installed and removed with the following tools:



Insert Bit

See page 137 - For more details on Driver Tools

M3



Imperial thread sizes 6-32, 832, 10-24, 10-32 and 1/4UNC also available.
Contact our sales team for pricing

PART NO.	LENGTH	DRIVE SIZE	HEAD DIA	HEAD HEIGHT	MATERIAL	\$/100
THPM310	10mm	TH3	5.8mm	1.8mm	304 S/S	\$110.00
THPM312	12mm	TH3	5.8mm	1.8mm	304 S/S	\$111.30
THPM316	16mm	TH3	5.8mm	1.8mm	304 S/S	\$113.20

M4



PART NO.	LENGTH	DRIVE SIZE	HEAD DIA	HEAD HEIGHT	MATERIAL	\$/100
THPM406	6mm	TH5	7.8mm	2.4mm	304 S/S	\$113.70
THPM410	10mm	TH5	7.8mm	2.4mm	304 S/S	\$115.90
THPM412	12mm	TH5	7.8mm	2.4mm	304 S/S	\$117.20
THPM416	16mm	TH5	7.8mm	2.4mm	304 S/S	\$119.20
THPM420	20mm	TH5	7.8mm	2.4mm	304 S/S	\$120.70
THPM425	25mm	TH5	7.8mm	2.4mm	304 S/S	\$125.70



2 HOLE PAN HEAD MACHINE SCREWS

Pan head shape has excellent visual effect and safety benefits.

Stocked in 304 Stainless steel, 316 Stainless steel, Zinc and Galvanised versions can be made to order.

Imperial thread sizes also available by special order.

2 hole driver system is tamper resistant and also popular for visual effect.

LEVEL 1:
Basic Security

Can be installed and removed with the following tools:

Insert Bit

See page 137 - For more details on Driver Tools



PART NO.	LENGTH	DRIVE SIZE	HEAD DIA	HEAD HEIGHT	MATERIAL	\$/100
THPM508	8mm	TH6	9.8mm	2.9mm	304 S/S	\$178.00
THPM512	12mm	TH6	9.8mm	2.9mm	304 S/S	\$117.80
THPM516	16mm	TH6	9.8mm	2.9mm	304 S/S	\$119.00
THPM520	20mm	TH6	9.8mm	2.9mm	304 S/S	\$124.40
THPM525	25mm	TH6	9.8mm	2.9mm	304 S/S	\$131.20
THPM530	30mm	TH6	9.8mm	2.9mm	304 S/S	\$141.90



PART NO.	LENGTH	DRIVE SIZE	HEAD DIA	HEAD HEIGHT	MATERIAL	\$/100
THPM612	12mm	TH8	11.8mm	3.5mm	304 S/S	\$143.40
THPM614	14mm	TH8	11.8mm	3.5mm	304 S/S	\$147.90
THPM616	16mm	TH8	11.8mm	3.5mm	304 S/S	\$152.20
THPM620	20mm	TH8	11.8mm	3.5mm	304 S/S	\$161.40
THPM625	25mm	TH8	11.8mm	3.5mm	304 S/S	\$164.00
THPM630	30mm	TH8	11.8mm	3.5mm	304 S/S	\$175.10
THPM635	35mm	TH8	11.8mm	3.5mm	304 S/S	\$290.00
THPM640	40mm	TH8	11.8mm	3.5mm	304 S/S	\$211.80
THPM650	50mm	TH8	11.8mm	3.5mm	304 S/S	\$325.00



TRUSS HEAD ALSO AVAILABLE
(Imperial thread sizes only)
CONTACT OUR SALES TEAM FOR DETAILS

2 HOLE COUNTERSUNK SELF TAPPERS

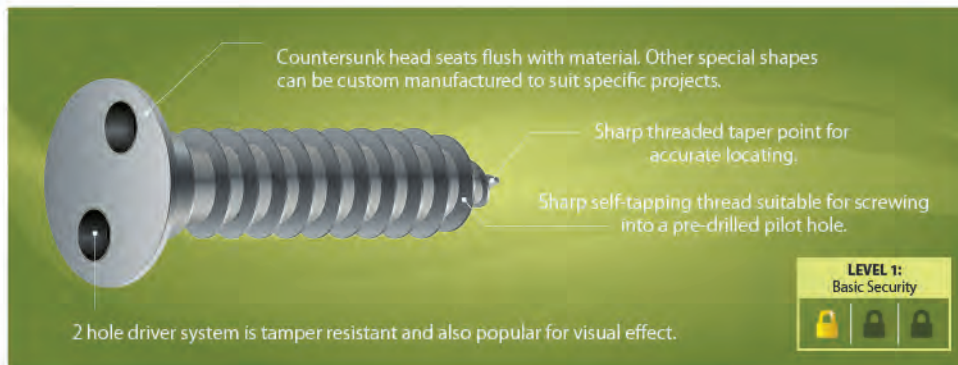

Can be installed and removed with the following tools:



See page 137 - For more details on Driver Tools



PART NO.	LENGTH	DRIVE SIZE	HEAD DIA	HEAD HEIGHT	MATERIAL	\$/100
THCS4A	6.3mm	TH3	5.5mm	2.0mm	304 S/S	\$72.00
THCS4C	9.5mm	TH3	5.5mm	2.0mm	304 S/S	\$74.00
THCS4D	13mm	TH3	5.5mm	2.0mm	304 S/S	\$75.60
THCS4F	19mm	TH3	5.5mm	2.0mm	304 S/S	\$77.30
THCS4G	25mm	TH3	5.5mm	2.0mm	304 S/S	\$79.80
THCS4H	32mm	TH3	5.5mm	2.0mm	304 S/S	\$79.80
THCS4I	38mm	TH3	5.5mm	2.0mm	304 S/S	\$81.50



We can supply broken packs just add 20%.

PART NO.	LENGTH	DRIVE SIZE	HEAD DIA	HEAD HEIGHT	MATERIAL	\$/100
THCS6C	9.5mm	TH4	6.7mm	2.5mm	304 S/S	\$78.30
THCS6D	13mm	TH4	6.7mm	2.5mm	304 S/S	\$80.30
THCS6E	16mm	TH4	6.7mm	2.5mm	304 S/S	\$81.10
THCS6F	19mm	TH4	6.7mm	2.5mm	304 S/S	\$82.40
THCS6G	25mm	TH4	6.7mm	2.5mm	304 S/S	\$83.50
THCS6H	32mm	TH4	6.7mm	2.5mm	304 S/S	\$90.20
THCS6I	38mm	TH4	6.7mm	2.5mm	304 S/S	\$100.00
THCS6J	50mm	TH4	6.7mm	2.5mm	304 S/S	\$116.60

2 HOLE COUNTERSUNK SELF TAPPERS

Countersunk head seats flush with material. Other special shapes can be custom manufactured to suit specific projects.

Sharp threaded taper point for accurate locating.

Sharp self-tapping thread suitable for screwing into a pre-drilled pilot hole.

2 hole driver system is tamper resistant and also popular for visual effect.

LEVEL 1:
Basic Security

Can be installed and removed with the following tools:

Insert Bit

See page 137 - For more details on Driver Tools



PART NO.	LENGTH	DRIVE SIZE	HEAD DIA	HEAD HEIGHT	MATERIAL	\$/100
THCS8C	9.5mm	TH5	7.9mm	2.8mm	304 S/S	\$88.10
THCS8D	13mm	TH5	7.9mm	2.8mm	304 S/S	\$89.40
THCS8E	16mm	TH5	7.9mm	2.8mm	304 S/S	\$90.50
THCS8F	19mm	TH5	7.9mm	2.8mm	304 S/S	\$91.80
THCS8G	25mm	TH5	7.9mm	2.8mm	304 S/S	\$93.30
THCS8H	32mm	TH5	7.9mm	2.8mm	304 S/S	\$100.40
THCS8I	38mm	TH5	7.9mm	2.8mm	304 S/S	\$109.60
THCS8J	50mm	TH5	7.9mm	2.8mm	304 S/S	\$124.70



PART NO.	LENGTH	DRIVE SIZE	HEAD DIA	HEAD HEIGHT	MATERIAL	\$/100
THCS10D	13mm	TH6	9mm	3.6mm	304 S/S	\$90.30
THCS10E	16mm	TH6	9mm	3.6mm	304 S/S	\$92.00
THCS10F	19mm	TH6	9mm	3.6mm	304 S/S	\$93.00
THCS10G	25mm	TH6	9mm	3.6mm	304 S/S	\$94.80
THCS10H	32mm	TH6	9mm	3.6mm	304 S/S	\$97.80
THCS10I	38mm	TH6	9mm	3.6mm	304 S/S	\$112.20
THCS10J	50mm	TH6	9mm	3.6mm	304 S/S	\$125.10
THCS10K	63mm	TH6	9mm	3.6mm	304 S/S	\$162.90

2 HOLE COUNTERSUNK SELF TAPPERS

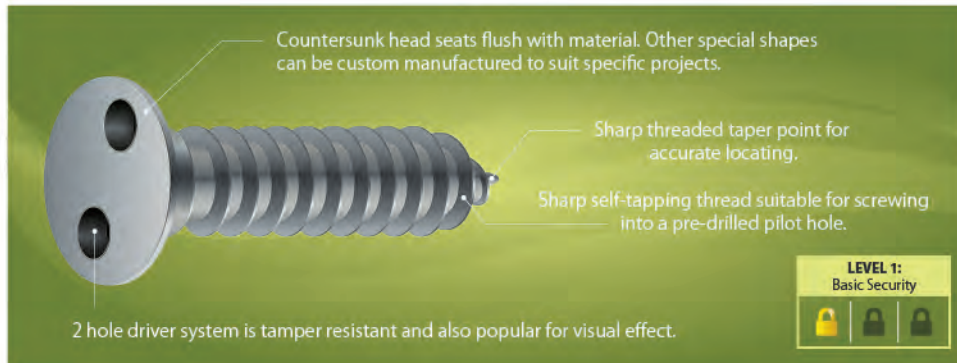

Can be installed and removed with the following tools:



Insert Bit

See page 137 - For more details on Driver Tools



PART NO.	LENGTH	DRIVE SIZE	HEAD DIA	HEAD HEIGHT	MATERIAL	\$/100
THCS12G	25mm	TH7	10.3mm	3.7mm	304 S/S	\$125.00
THCS12I	38mm	TH7	10.3mm	3.7mm	304 S/S	\$143.90
THCS12J	50mm	TH7	10.3mm	3.7mm	304 S/S	\$158.60



PART NO.	LENGTH	DRIVE SIZE	HEAD DIA	HEAD HEIGHT	MATERIAL	\$/100
THCS14E	16mm	TH8	12.2mm	4.6mm	304 S/S	\$143.10
THCS14F	19mm	TH8	12.2mm	4.6mm	304 S/S	\$144.00
THCS14G	25mm	TH8	12.2mm	4.6mm	304 S/S	\$144.80
THCS14H	32mm	TH8	12.2mm	4.6mm	304 S/S	\$156.70
THCS14I	38mm	TH8	12.2mm	4.6mm	304 S/S	\$159.20
THCS14J	50mm	TH8	12.2mm	4.6mm	304 S/S	\$171.70



2 HOLE PAN HEAD SELF TAPPERS

Pan head shape has excellent visual effect and safety benefits. Other special head shapes can be made to order.

Sharp threaded taper point for accurate locating.

Sharp self-tapping thread suitable for screwing into a pre-drilled hole.

2 hole driver system is tamper resistant and also popular for visual effect.

LEVEL 1:
Basic Security

Can be installed and removed with the following tools:

Insert Bit

See page 137 - For more details on Driver Tools



We can supply broken packs just add 20%.

PART NO.	LENGTH	DRIVE SIZE	HEAD DIA	HEAD HEIGHT	MATERIAL	\$/100
THPS4C	9.5mm	TH3	5.4mm	1.6mm	304 S/S	\$74.00
THPS4D	13mm	TH3	5.4mm	1.6mm	304 S/S	\$75.60
THPS4E	16mm	TH3	5.4mm	1.6mm	304 S/S	\$76.50
THPS4F	19mm	TH3	5.4mm	1.6mm	304 S/S	\$77.30
THPS4G	25mm	TH3	5.4mm	1.6mm	304 S/S	\$79.80
THPS4I	38mm	TH3	5.4mm	1.6mm	304 S/S	\$81.50



PART NO.	LENGTH	DRIVE SIZE	HEAD DIA	HEAD HEIGHT	MATERIAL	\$/100
THPS6A	6.35mm	TH4	6.7mm	2.0mm	304 S/S	\$132.00
THPS6C	9.5mm	TH4	6.7mm	2.0mm	304 S/S	\$78.30
THPS6D	13mm	TH4	6.7mm	2.0mm	304 S/S	\$80.30
THPS6E	16mm	TH4	6.7mm	2.0mm	304 S/S	\$81.10
THPS6F	19mm	TH4	6.7mm	2.0mm	304 S/S	\$82.40
THPS6G	25mm	TH4	6.7mm	2.0mm	304 S/S	\$83.50
THPS6H	32mm	TH4	6.7mm	2.0mm	304 S/S	\$90.20
THPS6I	38mm	TH4	6.7mm	2.0mm	304 S/S	\$100.00
THPS6J	50mm	TH4	6.7mm	2.0mm	304 S/S	\$116.60

2 HOLE PAN HEAD SELF TAPPERS

Pan head shape has excellent visual effect and safety benefits. Other special head shapes can be made to order.

Sharp threaded taper point for accurate locating.

Sharp self-tapping thread suitable for screwing into a pre-drilled hole.

2 hole driver system is tamper resistant and also popular for visual effect.

LEVEL 1:
Basic Security

Can be installed and removed with the following tools:

Insert Bit

See page 137 - For more details on Driver Tools



PART NO.	LENGTH	DRIVE SIZE	HEAD DIA	HEAD HEIGHT	MATERIAL	\$/100
THPS8C	9.5mm	TH5	8mm	2.3mm	304 S/S	\$88.10
THPS8D	13mm	TH5	8mm	2.3mm	304 S/S	\$89.40
THPS8E	16mm	TH5	8mm	2.3mm	304 S/S	\$90.50
THPS8F	19mm	TH5	8mm	2.3mm	304 S/S	\$91.80
THPS8G	25mm	TH5	8mm	2.3mm	304 S/S	\$93.30
THPS8H	32mm	TH5	8mm	2.3mm	304 S/S	\$100.40
THPS8I	38mm	TH5	8mm	2.3mm	304 S/S	\$109.60
THPS8J	50mm	TH5	8mm	2.3mm	304 S/S	\$124.70



PART NO.	LENGTH	DRIVE SIZE	HEAD DIA	HEAD HEIGHT	MATERIAL	\$/100
THPS10C	9.5mm	TH6	9.2mm	2.7mm	304 S/S	\$90.30
THPS10D	13mm	TH6	9.2mm	2.7mm	304 S/S	\$92.00
THPS10E	16mm	TH6	9.2mm	2.7mm	304 S/S	\$93.00
THPS10F	19mm	TH6	9.2mm	2.7mm	304 S/S	\$94.80
THPS10G	25mm	TH6	9.2mm	2.7mm	304 S/S	\$97.80
THPS10H	32mm	TH6	9.2mm	2.7mm	304 S/S	\$112.20
THPS10I	38mm	TH6	9.2mm	2.7mm	304 S/S	\$125.10
THPS10J	50mm	TH6	9.2mm	2.7mm	304 S/S	\$162.90
THPS10K	63mm	TH6	9.2mm	2.7mm	304 S/S	\$164.10

2 HOLE PAN HEAD SELF TAPPERS

Pan head shape has excellent visual effect and safety benefits. Other special head shapes can be made to order.

Sharp threaded taper point for accurate locating.

Sharp self-tapping thread suitable for screwing into a pre-drilled hole.

2 hole driver system is tamper resistant and also popular for visual effect.

LEVEL 1:
Basic Security

Can be installed and removed with the following tools:

Insert Bit

See page 137 - For more details on Driver Tools



PART NO.	LENGTH	DRIVE SIZE	HEAD DIA	HEAD HEIGHT	MATERIAL	\$/100
THPS12D	13mm	TH7	10.5mm	3.2mm	304 S/S	\$125.00
THPS12G	25mm	TH7	10.5mm	3.2mm	304 S/S	\$134.40
THPS12J	50mm	TH7	10.5mm	3.2mm	304 S/S	\$158.60



PART NO.	LENGTH	DRIVE SIZE	HEAD DIA	HEAD HEIGHT	MATERIAL	\$/100
THPS14D	13mm	TH8	12.2mm	3.5mm	304 S/S	\$140.70
THPS14E	16mm	TH8	12.2mm	3.5mm	304 S/S	\$143.10
THPS14F	19mm	TH8	12.2mm	3.5mm	304 S/S	\$144.00
THPS14G	25mm	TH8	12.2mm	3.5mm	304 S/S	\$144.80
THPS14H	32mm	TH8	12.2mm	3.5mm	304 S/S	\$156.70
THPS14I	38mm	TH8	12.2mm	3.5mm	304 S/S	\$159.20
THPS14J	50mm	TH8	12.2mm	3.5mm	304 S/S	\$171.70



ALSO AVAILABLE IN A TRUSS HEAD VERSION
CONTACT OUR SALES TEAM FOR DETAILS

TORXPLUS COUNTERSUNK SELF TAPPERS



Can be installed and removed with the following tools:

Insert Bit

See page 134 - For more details on Driver Tools



Also available in 6 lobe drive
see pages 22-24

PART NO.	LENGTH	DRIVE SIZE	HEAD DIA	HEAD HEIGHT	MATERIAL	\$/100
TPCS6D	13mm	15 IPR	6.9mm	2.8mm	304 S/S	\$131.60
TPCS6F	19mm	15 IPR	6.9mm	2.8mm	304 S/S	\$148.40
TPCS6G	25mm	15 IPR	6.9mm	2.8mm	304 S/S	\$173.20
TPCS6I	38mm	15 IPR	6.9mm	2.8mm	304 S/S	\$177.00



PART NO.	LENGTH	DRIVE SIZE	HEAD DIA	HEAD HEIGHT	MATERIAL	\$/100
TPCS8D	13mm	20 IPR	7.9mm	2.5mm	304 S/S	\$134.50
TPCS8F	19mm	20 IPR	7.9mm	2.5mm	304 S/S	\$142.00
TPCS8G	25mm	20 IPR	7.9mm	2.5mm	304 S/S	\$148.80
TPCS8H	32mm	20 IPR	7.9mm	2.5mm	304 S/S	\$179.10
TPCS8I	38mm	20 IPR	7.9mm	2.5mm	304 S/S	\$189.70



TORXPLUS COUNTERSUNK SELF TAPPERS



Can be installed and removed with the following tools:

Insert Bit

See page 134 - For more details on Driver Tools



Also available in 6 lobe drive
see pages 22-24

PART NO.	LENGTH	DRIVE SIZE	HEAD DIA	HEAD HEIGHT	MATERIAL	\$/100
TPCS10D	13mm	25 IPR	9.3mm	3mm	304 S/S	\$144.10
TPCS10F	19mm	25 IPR	9.3mm	3mm	304 S/S	\$148.50
TPCS10G	25mm	25 IPR	9.3mm	3mm	304 S/S	\$167.60
TPCS10H	32mm	25 IPR	9.3mm	3mm	304 S/S	\$209.90
TPCS10I	38mm	25 IPR	9.3mm	3mm	304 S/S	\$236.40



PART NO.	LENGTH	DRIVE SIZE	HEAD DIA	HEAD HEIGHT	MATERIAL	\$/100
TPCS14F	19mm	30 IPR	12.8mm	5.2mm	304 S/S	\$239.10
TPCS14G	25mm	30 IPR	12.8mm	5.2mm	304 S/S	\$277.90
TPCS14H	32mm	30 IPR	12.8mm	5.2mm	304 S/S	\$287.10
TPCS14I	38mm	30 IPR	12.8mm	5.2mm	304 S/S	\$308.70



TORXPLUS BUTTON HEAD SELF TAPPERS

5 lobe TorxPLUS drive requires special tooling and can be tightened with high torque.

Sharp threaded taper point for accurate locating.

Manufactured in 304 stainless steel.

Domed button head shape has excellent visual effect and safety benefits.

LEVEL 1:
Basic Security

Can be installed and removed with the following tools:

Insert Bit

See page 134 - For more details on Driver Tools

6G

Also available in 6 lobe drive
see pages 25-27

PART NO.	LENGTH	DRIVE SIZE	HEAD DIA	HEAD HEIGHT	MATERIAL	\$/100
TPBS6D	13mm	10 IPR	6.7mm	2.5mm	304 S/S	\$131.60
TPBS6F	19mm	10 IPR	6.7mm	2.5mm	304 S/S	\$148.40
TPBS6G	25mm	10 IPR	6.7mm	2.5mm	304 S/S	\$173.20
TPBS6I	38mm	10 IPR	6.7mm	2.5mm	304 S/S	\$177.00

8G

PART NO.	LENGTH	DRIVE SIZE	HEAD DIA	HEAD HEIGHT	MATERIAL	\$/100
TPBS8D	13mm	15 IPR	7.8mm	2.1mm	304 S/S	\$134.50
TPBS8F	19mm	15 IPR	7.8mm	2.1mm	304 S/S	\$142.00
TPBS8G	25mm	15 IPR	7.8mm	2.1mm	304 S/S	\$148.80
TPBS8H	32mm	15 IPR	7.8mm	2.1mm	304 S/S	\$179.10
TPBS8I	38mm	15 IPR	7.8mm	2.1mm	304 S/S	\$189.70



TORXPLUS BUTTON HEAD SELF TAPPERS

5 lobe TorxPLUS drive requires special tooling and can be tightened with high torque.

Sharp threaded taper point for accurate locating.

Manufactured in 304 stainless steel.

Domed button head shape has excellent visual effect and safety benefits.

LEVEL 1:
Basic Security

Can be installed and removed with the following tools:

Insert Bit

See page 134 - For more details on Driver Tools

10G

Also available in 6 lobe drive
see pages 25-27

PART NO.	LENGTH	DRIVE SIZE	HEAD DIA	HEAD HEIGHT	MATERIAL	\$/100
TPBS10D	13mm	25 IPR	9.3mm	2.6mm	304 S/S	\$144.10
TPBS10F	19mm	25 IPR	9.3mm	2.6mm	304 S/S	\$148.50
TPBS10G	25mm	25 IPR	9.3mm	2.6mm	304 S/S	\$167.60
TPBS10H	32mm	25 IPR	9.3mm	2.6mm	304 S/S	\$209.90
TPBS10I	38mm	25 IPR	9.3mm	2.6mm	304 S/S	\$236.40

14G

PART NO.	LENGTH	DRIVE SIZE	HEAD DIA	HEAD HEIGHT	MATERIAL	\$/100
TPBS14D	13mm	27 IPR	11.0mm	3.4mm	303 S/S	\$234.22
TPBS14F	19mm	27 IPR	11.0mm	3.4mm	303 S/S	\$239.10
TPBS14G	25mm	27 IPR	11.0mm	3.4mm	303 S/S	\$277.90
TPBS14H	32mm	27 IPR	11.0mm	3.4mm	303 S/S	\$287.10
TPBS14I	38mm	27 IPR	11.0mm	3.4mm	303 S/S	\$308.70



TRI-LOBULAR BUTTON HEAD TYPE 17 SCREWS

Domed button head shape has excellent visual effect and safety benefits.

Sharp type 17 taper point for accurate locating and positive cutting thrust to eliminate splitting in timber.

Self-tapping thread precision manufactured with yellow zinc or galvanised plating. Selected sizes stocked in Stainless steel.

Triangular shaped recess for security.

LEVEL 1:
Basic Security

Can be installed and removed with the following tools:

Insert Bit

See page 136 - For more details on Driver Tools

10G

PART NO.	LENGTH	DRIVE SIZE	HEAD DIA	HEAD HEIGHT	MATERIAL	S/100	S/1000
TLBT10F-Z	19mm	TL2	9.0mm	3.3mm	Zinc	\$12.41	\$103.40
TLBT10F-G	19mm	TL2	9.0mm	3.3mm	Galvanised	\$15.18	\$126.50
TLBT10G-Z	25mm	TL2	9.0mm	3.3mm	Zinc	\$13.20	\$110.00
TLBT10G-G	25mm	TL2	9.0mm	3.3mm	Galvanised	\$16.50	\$137.50
TLBT10H-Z	32mm	TL2	9.0mm	3.3mm	Zinc	\$14.52	\$121.00
TLBT10H-G	32mm	TL2	9.0mm	3.3mm	Galvanised	\$18.00	\$150.00
TLBT10H-S	32mm	TL2	9.0mm	3.3mm	304 S/S	\$90.00	\$750.00
TLBT10I-Z	38mm	TL2	9.0mm	3.3mm	Zinc	\$16.50	\$121.00
TLBT10I-G	38mm	TL2	9.0mm	3.3mm	Galvanised	\$19.80	\$165.00
TLBT10I-S	38mm	TL2	9.0mm	3.3mm	304 S/S	\$108.00	\$900.00

TRI-LOBULAR BUTTON HEAD SELF DRILLER

Domed pan head shape has excellent visual effect and safety benefits.

Sharp self-drilling tip for effective pre-drilling maximises work efficiency.

Stocked in Galvanised steel.

Triangular shaped recess for security.

LEVEL 1:
Basic Security

Can be installed and removed with the following tools:

Insert Bit

See page 136 - For more details on Driver Tools

10G

PART NO.	LENGTH	DRIVE SIZE	HEAD DIA	HEAD HEIGHT	MATERIAL	S/100	S/1000
TLBSD10E-G	16mm	TL2	9.0mm	3.3mm	Galvanised	\$14.40	\$120.00

TRI-LOBULAR MACHINE SCREW



Can be installed and removed with the following tools:

Insert Bit

Key Wrench

See page 136 - For more details on Driver Tools

M10

PART NO.	LENGTH	DRIVE SIZE	HEAD DIA	HEAD HEIGHT	MATERIAL	\$/100
TLBM1017-Z	17mm	TL10	19.3mm	6.9mm	Zinc	\$60.00
TLBM1017-S	17mm	TL10	19.3mm	6.9mm	304 S/S	\$360.00
TLBM1020-Z	20mm	TL10	19.3mm	6.9mm	Zinc	\$73.00
TLBM1020-S	20mm	TL10	19.3mm	6.9mm	304 S/S	\$370.00
TLBM1025-Z	25mm	TL10	19.3mm	6.9mm	Zinc	\$86.00
TLBM1025-S	25mm	TL10	19.3mm	6.9mm	304 S/S	\$440.00
TLBM1040-Z	40mm	TL10	19.3mm	6.9mm	Zinc	\$134.00
TLBM1040-S	40mm	TL10	19.3mm	6.9mm	304 S/S	\$596.00

M10 CA POINT

CA Point is the new, improved version of the Cone Point, used to grip into post for Road Sign installations.

PART NO.	LENGTH	DRIVE SIZE	HEAD DIA	HEAD HEIGHT	MATERIAL	\$/100
TLBM1018CA	18mm	TL10	19.3mm	6.9mm	Zinc	\$66.00
TLBM1019CA	19mm	TL10	19.3mm	6.9mm	Zinc	\$75.00
TLBM1021CA	21mm	TL10	19.3mm	6.9mm	Zinc	\$75.00
TLBM1035CA	35mm	TL10	19.3mm	6.9mm	Zinc	\$170.00

M10 Threadforming Screws

PART NO.	LENGTH	DRIVE SIZE	HEAD DIA	HEAD HEIGHT	MATERIAL	\$/100
TLBTT1015-YZ	15mm	TL10	19.3mm	6.9mm	Zinc Yellow	\$230.00
TLBTT1022-G	22mm	TL10	19.3mm	6.9mm	Galvanised	\$120.00

OVAL PAN HEAD MACHINE SCREWS

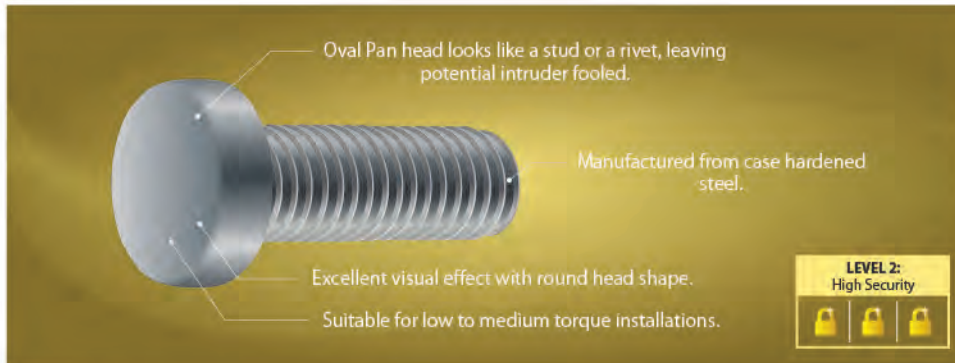

Can be installed and removed with the following tools:

Insert Bit

See page 137 - For more details on Driver Tools



Excellent visual effect with round head shape.

PART NO.	LENGTH	DRIVE SIZE	HEAD DIA	HEAD HEIGHT	MATERIAL	\$/100
OPHM412	12mm	PHD1	6.8mm	2.8mm	Zinc	\$170.20
OPHM416	16mm	PHD1	6.8mm	2.8mm	Zinc	\$176.30
OPHM420	20mm	PHD1	6.8mm	2.8mm	Zinc	\$183.30
OPHM425	25mm	PHD1	6.8mm	2.8mm	Zinc	\$189.90
OPHM430	30mm	PHD1	6.8mm	2.8mm	Zinc	\$195.70
OPHM440	40mm	PHD1	6.8mm	2.8mm	Zinc	\$203.20



PART NO.	LENGTH	DRIVE SIZE	HEAD DIA	HEAD HEIGHT	MATERIAL	\$/100
OPHM510	10mm	PHD2	9.9mm	3.5mm	Zinc	\$184.10
OPHM512	12mm	PHD2	9.9mm	3.5mm	Zinc	\$187.70
OPHM516	16mm	PHD2	9.9mm	3.5mm	Zinc	\$193.30
OPHM520	20mm	PHD2	9.9mm	3.5mm	Zinc	\$198.40
OPHM525	25mm	PHD2	9.9mm	3.5mm	Zinc	\$205.00
OPHM530	30mm	PHD2	9.9mm	3.5mm	Zinc	\$218.60
OPHM540	40mm	PHD2	9.9mm	3.5mm	Zinc	\$224.50

OVAL PAN HEAD MACHINE SCREWS

Oval Pan head looks like a stud or a rivet, leaving potential intruder fooled.

Manufactured from case hardened steel.

Excellent visual effect with round head shape.

Suitable for low to medium torque installations.

LEVEL 2:
High Security

Can be installed and removed with the following tools:

Insert Bit

See page 137 - For more details on Driver Tools



Excellent visual effect with round head shape.

PART NO.	LENGTH	DRIVE SIZE	HEAD DIA	HEAD HEIGHT	MATERIAL	\$/100
OPHM610	10mm	PHD2	9.9mm	3.5mm	Zinc	\$207.70
OPHM612	12mm	PHD2	9.9mm	3.5mm	Zinc	\$214.10
OPHM616	16mm	PHD2	9.9mm	3.5mm	Zinc	\$222.60
OPHM620	20mm	PHD2	9.9mm	3.5mm	Zinc	\$228.20
OPHM625	25mm	PHD2	9.9mm	3.5mm	Zinc	\$233.80
OPHM630	30mm	PHD2	9.9mm	3.5mm	Zinc	\$243.40
OPHM640	40mm	PHD2	9.9mm	3.5mm	Zinc	\$251.60



ALSO AVAILABLE AS SELF TAPPING SCREWS BY SPECIAL ORDER
CONTACT OUR SALES TEAM FOR DETAILS

QUADTECH BUTTON HEAD TYPE 17 SCREW

Domed button head shape has excellent visual effect and safety benefits.

Sharp type 17 taper point for accurate locating and positive cutting thrust to eliminate splitting in timber.

Stocked in Galvanised steel.

Square drive with Pin recess offers both security and positive drive benefits of the Square recess.

LEVEL 1:
Basic Security

Can be installed and removed with the following tools:

Insert Bit

See page 136 - For more details on Driver Tools

10G

PART NO.	LENGTH	DRIVE SIZE	HEAD DIA	HEAD HEIGHT	MATERIAL	\$/100	\$/1000
QTBS10F-G	19mm	SD2	9.3mm	3.5mm	Galvanised	\$13.80	\$115.00
QTBS10G-G	25mm	SD2	9.3mm	3.5mm	Galvanised	\$17.10	\$142.50
QTBS10I-G	38mm	SD2	9.3mm	3.5mm	Galvanised	\$19.32	\$161.00



QUADTECH BUTTON HEAD SELF DRILLING SCREW

Domed button head shape has excellent visual effect and safety benefits.

Sharp self drilling tip for effective pre drilling maximises work efficiency.

Stocked in Galvanised steel.

Square drive with Pin recess offers both security and positive drive benefits of the Square recess.

LEVEL 1:
Basic Security

Can be installed and removed with the following tools:

Insert Bit

See page 136 - For more details on Driver Tools



PART NO.	LENGTH	DRIVE SIZE	HEAD DIA	HEAD HEIGHT	MATERIAL	\$/100	\$/1000
QTPSD10E-G	16mm	SD2	9.3mm	3.5mm	Galvanised	\$16.56	\$138.00



If your application requires
HIGH SECURITY
UNI-SET is the ultimate solution

**Made to order with a new shape for each new customer.*

Millions of UNI-SET shapes mean each user has a proprietary security fastener.

Button or flat head
repel "vice-grips".

Forged of Stainless Steel,
UNI-SET is rustproof
and tough.



Each shape is engineered to keep other "tamper-resistant" bits out, making UNI-SET the most secure fastener available.

Complex keys prevent
duplication, assuring
only authorized access.

Keys are made from
aircraft alloy steel and
heat treated through
a special process to
give the service required.



UNI-SET

HIGH SECURITY LOCKING SYSTEM

**With each customer having a unique drive code,
this is truly a lock, not just a security screw**

UNISET ULTIMATE SECURITY SYSTEM

Each shape is engineered to keep other "tamper-resistant" bits out, making UNI-SET the most secure fastener available.

Forged of Stainless Steel, UNI-SET is rustproof and tough.

Button or flat head repel "vice-grips".

Millions of UNI-SET shapes mean each user has a proprietary security fastener.

LEVEL 3:
Maximum Security

Can be installed and removed with the following tools:

Insert Bit

Requires a perfectly cut key to operate.

COUNTERSUNK SELF TAPPING SCREWS

MADE TO ORDER: From 4G to 14G diameter, 3/8" up to 4" long.

Made to order with a new shape for each new customer.

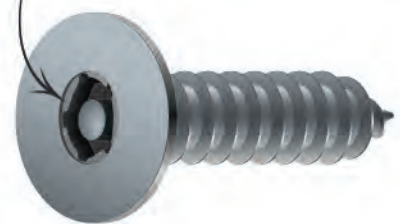

BUTTON HEAD SELF TAPPING SCREWS

MADE TO ORDER: From 4G to 14G diameter, 3/8" up to 4" long.

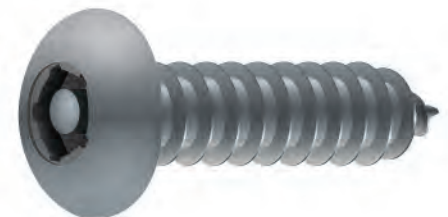

COUNTERSUNK MACHINE SCREWS

MADE TO ORDER: From M2 up to M16 diameter, 4mm up to 100mm long.

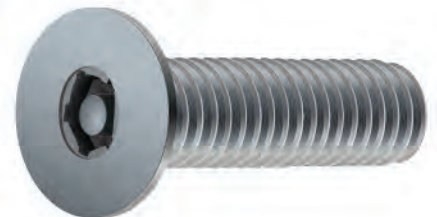

BUTTON HEAD MACHINE SCREWS

MADE TO ORDER: From M2 up to M16 diameter, 4mm up to 100mm long.

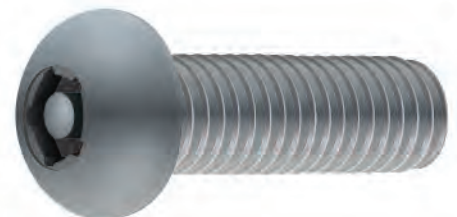

KINMAR REMOVABLE NUTS



Patented product, with unique drive sockets only available through approved distributors.

The most cost effective removable security nut on the market.

Stocked in Zinc plated, Galvanised and Stainless steel.



Can be installed and removed with the following tools:



Drive Socket

See page 136 - For more details on Driver Tools

M5



PART NO.	DRIVE SIZE	HEAD DIA	HEAD HEIGHT	MATERIAL	\$/ea	\$/100
KM5R-Z	KM6R	12.1mm	5.6mm	Zinc	\$2.33	\$194.00
KM5R-S	KM6R	12.1mm	5.6mm	304 S/S	\$3.84	\$320.00

M6



PART NO.	DRIVE SIZE	HEAD DIA	HEAD HEIGHT	MATERIAL	\$/ea	\$/100
KM6R-Z	KM6R	12.1mm	5.6mm	Zinc	\$2.33	\$194.00
KM6R-G	KM6R	12.1mm	5.6mm	Galvanised	\$2.76	\$230.00
KM6R-S	KM6R	12.1mm	5.6mm	304 S/S	\$3.84	\$320.00

M8



PART NO.	DRIVE SIZE	HEAD DIA	HEAD HEIGHT	MATERIAL	\$/ea	\$/100
KM8R-Z	KM8R	16.1mm	7.3mm	Zinc	\$2.64	\$220.00
KM8R-G	KM8R	16.1mm	7.3mm	Galvanised	\$3.00	\$250.00
KM8R-S	KM8R	16.1mm	7.3mm	304 S/S	\$4.26	\$355.00

KINMAR REMOVABLE NUTS

Patented product, with unique drive sockets only available through approved distributors.

The most cost effective removable security nut on the market.

Stocked in Zinc plated, Galvanised and Stainless steel.

LEVEL 2:
High Security

Can be installed and removed with the following tools:

Drive Socket

See page 136 - For more details on Driver Tools

M10

PART NO.	DRIVE SIZE	HEAD DIA	HEAD HEIGHT	MATERIAL	\$/ea	\$/100
KM10R-Z	KM10R	20.1mm	9.1mm	Zinc	\$3.74	\$312.00
KM10R-G	KM10R	20.1mm	9.1mm	Galvanised	\$4.44	\$370.00
KM10R-S	KM10R	20.1mm	9.1mm	304 S/S	\$6.24	\$520.00

M12

PART NO.	DRIVE SIZE	HEAD DIA	HEAD HEIGHT	MATERIAL	\$/ea	\$/100
KM12R-Z	KM12R	24.2mm	10.5mm	Zinc	\$4.37	\$364.00
KM12R-G	KM12R	24.2mm	10.5mm	Galvanised	\$4.86	\$405.00
KM12R-S	KM12R	24.2mm	10.5mm	304 S/S	\$10.18	\$848.00



KINMAR PERMANENT NUTS

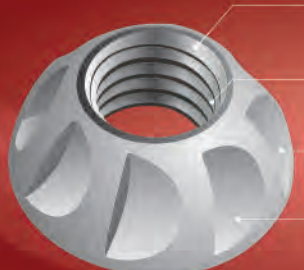

Superior alternative to the shear nut, leaving no unplated surfaces.

Driver socket will only tighten this nut, no tool for removal.

Patented, high torque security nut.

Stocked in Zinc plated, Galvanised and Stainless steel.

LEVEL 3:
Maximum Security



Can be installed and removed with the following tools:



Drive Socket

See page 136 - For more details on Driver Tools

M5



PART NO.	DRIVE SIZE	HEAD DIA	HEAD HEIGHT	MATERIAL	\$/ea	\$/100
KM5N-Z	KM6P	12.1mm	5.6mm	Zinc	\$2.86	\$238.00
KM5N-S	KM6P	12.1mm	5.6mm	304 S/S	\$4.02	\$335.00

M6



PART NO.	DRIVE SIZE	HEAD DIA	HEAD HEIGHT	MATERIAL	\$/ea	\$/100
KM6N-Z	KM6P	12.1mm	5.6mm	Zinc	\$2.86	\$238.00
KM6N-G	KM6P	12.1mm	5.6mm	Galvanised	\$2.95	\$246.00
KM6N-S	KM6P	12.1mm	5.6mm	304 S/S	\$4.03	\$336.00

M8



PART NO.	DRIVE SIZE	HEAD DIA	HEAD HEIGHT	MATERIAL	\$/ea	\$/100
KM8N-Z	KM8P	16.1mm	7.3mm	Zinc	\$3.00	\$250.30
KM8N-G	KM8P	16.1mm	7.3mm	Galvanised	\$3.30	\$275.40
KM8N-S	KM8P	16.1mm	7.3mm	304 S/S	\$4.68	\$389.90

KINMAR PERMANENT NUTS

Superior alternative to the shear nut, leaving no unplated surfaces.

Driver socket will only tighten this nut, no tool for removal.

Patented, high torque security nut.

Stocked in Zinc plated, Galvanised and Stainless steel.

LEVEL 3:
Maximum Security

Can be installed and removed with the following tools:

Drive Socket

See page 136 - For more details on Driver Tools

M10

PART NO.	DRIVE SIZE	HEAD DIA	HEAD HEIGHT	MATERIAL	\$/ea	\$/100
KM10N-Z	KM10P	20.1mm	9.1mm	Zinc	\$4.01	\$333.80
KM10N-G	KM10P	20.1mm	9.1mm	Galvanised	\$4.39	\$365.70
KM10N-S	KM10P	20.1mm	9.1mm	304 S/S	\$6.46	\$538.00

M12

PART NO.	DRIVE SIZE	HEAD DIA	HEAD HEIGHT	MATERIAL	\$/ea	\$/100
KM12N-Z	KM12P	24.2mm	10.5mm	Zinc	\$4.35	\$362.90
KM12N-G	KM12P	24.2mm	10.5mm	Galvanised	\$4.79	\$399.20
KM12N-S	KM12P	24.2mm	10.5mm	304 S/S	\$10.15	\$846.00



KINMAR REMOVABLE BOLTS

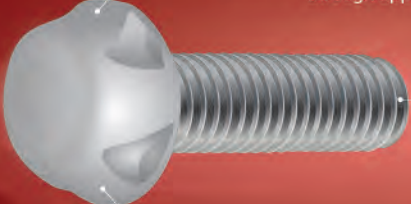

Patented product with driver sockets only available through approved distributors.

Stocked in Zinc plated and galvanised. Stainless steel can be made to order subject to minimum order quantities.

Matching bolt for the Kinmar Removable nut.

LEVEL 2:
High Security



Can be installed and removed with the following tools:



Drive Socket

See page 136 - For more details on Driver Tools



PART NO.	LENGTH	DRIVE SIZE	HEAD DIA	HEAD HEIGHT	MATERIAL	\$/ea	\$/100
KMB825R-Z	25mm	KM8R	16.1mm	7.3mm	Zinc	\$5.70	\$457.00
KMB825R-G	25mm	KM8R	16.1mm	7.3mm	Galvanised	\$6.00	\$480.00
KMB835R-G	35mm	KM8R	16.1mm	7.3mm	Galvanised	\$6.25	\$499.00
KMB840R-Z	40mm	KM8R	16.1mm	7.3mm	Zinc	\$5.90	\$475.00
KMB840R-G	40mm	KM8R	16.1mm	7.3mm	Galvanised	\$6.30	\$504.00



KINMAR PERMANENT BOLTS



Patented, non-removable product with driver sockets only available through approved distributors.

Stocked in Zinc plated and galvanised. Stainless steel can be made to order subject to minimum order quantities.

Matching bolt for the Kinmar Permanent nut.

LEVEL 3:
Maximum Security



Can be installed and removed with the following tools:



Drive Socket

See page 136 - For more details on Driver Tools



PART NO.	LENGTH	DRIVE SIZE	HEAD DIA	HEAD HEIGHT	MATERIAL	\$/ea	\$/100
KMB825P-Z	25mm	KM8P	16.1mm	7.3mm	Zinc	\$5.41	\$433.00
KMB825P-G	25mm	KM8P	16.1mm	7.3mm	Galvanised	\$5.85	\$468.00
KMB840P-Z	40mm	KM8P	16.1mm	7.3mm	Zinc	\$6.40	\$512.00
KMB840P-G	40mm	KM8P	16.1mm	7.3mm	Galvanised	\$6.75	\$540.00



SHEAR NUTS



- Non removable, high security nut.
- Hexagonal part shears off under torque, leaving a tamper resistant cone.
- No specialist tools required - installed with a standard socket or spanner.
- Stocked in Zinc plated, Galvanised and Stainless steel.

LEVEL 3:
Maximum Security



Can be installed and removed with the following tools:



Spanner

M6



PART NO.	DRIVE SIZE	LB/FT	SHEAR	NM	MATERIAL	\$/ea	\$/100
SHN6-Z	14mm	5 - 9		7 - 14	Zinc	\$1.75	\$146.00
SHN6-S	10mm	5 - 9		7 - 14	304 S/S	\$3.22	\$268.00

M8



PART NO.	DRIVE SIZE	LB/FT	SHEAR	NM	MATERIAL	\$/ea	\$/100
SHN8-Z	16mm	10 - 15		14 - 20	Zinc	\$1.84	\$153.00
SHN8-G	16mm	10 - 15		14 - 20	Galvanised	\$1.92	\$160.00
SHN8-S	13mm	10 - 15		14 - 20	304 S/S	\$3.70	\$308.00

M10



PART NO.	DRIVE SIZE	LB/FT	SHEAR	NM	MATERIAL	\$/ea	\$/100
SHN10-Z	19mm	23 - 28		31 - 38	Zinc	\$2.42	\$202.00
SHN10-G	19mm	23 - 28		31 - 38	Galvanised	\$3.74	\$312.00
SHN10-S	17mm	23 - 28		31 - 38	304 S/S	\$5.54	\$462.00

Imp.



PART NO.	DRIVE SIZE	LB/FT	SHEAR	NM	MATERIAL	\$/ea	\$/100
SHN5/16-Z	16mm	7 - 10		10 - 14	Zinc	\$3.54	\$295.00
SHN3/8-Z	19mm	10 - 13		15 - 17	Zinc	\$5.40	\$450.00

SHEAR NUTS

Non removable, high security nut.

Hexagonal part shears off under torque, leaving a tamper resistant cone.

No specialist tools required - installed with a standard socket or spanner.

Stocked in Zinc plated, Galvanised and Stainless steel.

LEVEL 3:
Maximum Security

Can be installed and removed with the following tools:

Spanner

M12

PART NO.	DRIVE SIZE 	LB/FT	SHEAR 	NM	MATERIAL 	\$/ea 	\$/100
SHN12-Z	22mm	38 - 44		56 - 60	Zinc	\$3.50	\$292.00
SHN12-G	22mm	38 - 44		56 - 60	Galvanised	\$5.02	\$418.00
SHN12-S	19mm	38 - 44		56 - 60	304 S/S	\$6.60	\$550.00

M16

PART NO.	DRIVE SIZE 	LB/FT	SHEAR 	NM	MATERIAL 	\$/ea 	\$/100
SHN16-Z	27mm	54 - 60		74 - 82	Zinc	\$8.75	\$729.00
SHN16-G	27mm	54 - 60		74 - 82	Galvanised	\$8.28	\$690.00
SHN16-S	24mm	54 - 60		74 - 82	304 S/S	\$12.60	\$1,050.00

M20

PART NO.	DRIVE SIZE 	LB/FT	SHEAR 	NM	MATERIAL 	\$/ea 	\$/100
SHN20-Z	32mm	72 - 82		100 - 113	Zinc	\$24.19	\$2,016.00
SHN20-G	32mm	72 - 82		100 - 113	Galvanised	\$25.44	\$2,120.00
SHN20-S	30mm	72 - 82		100 - 113	304 S/S	\$46.56	\$3,880.00



SHEAR BOLTS

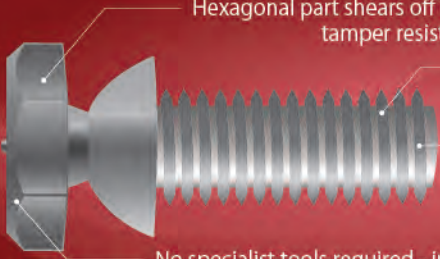

Hexagonal part shears off under torque, leaving a tamper resistant cone.

Non Removable, high security bolt.

Stocked in Stainless steel. Zinc plated and galvanised can be made to order subject to minimum order quantities.

No specialist tools required - installed with a standard socket or spanner.

LEVEL 3:
Maximum Security





Can be installed and removed with the following tools:





Spanner



PART NO.	DRIVE SIZE	LB/FT	SHEAR	NM	MATERIAL	\$/ea	\$/100
SHBM616-A2	16mm	5 - 9		7 - 14	304 S/S	\$5.00	\$400.40
SHBM625-A2	25mm	5 - 9		7 - 14	304 S/S	\$6.26	\$500.85
SHBM650-A2	50mm	5 - 9		7 - 14	304 S/S	\$9.38	\$750.40



PART NO.	DRIVE SIZE	LB/FT	SHEAR	NM	MATERIAL	\$/ea	\$/100
SHBM825-A2	16mm	10 - 15		14 - 20	304 S/S	\$9.09	\$727.13
SHBM860-A2	25mm	10 - 15		14 - 20	304 S/S	\$16.74	\$1,339.45

INSTALLATION INSTRUCTIONS



1 Insert Shear Bolt into application



2 Tighten using standard spanner



3 Hex part shears off at set torque to leave a smooth permanent flush

SHEAR BOLTS

Hexagonal part shears off under torque, leaving a tamper resistant cone.

Non Removable, high security bolt.

Stocked in Stainless steel. Zinc plated and galvanised can be made to order subject to minimum order quantities.

No specialist tools required - installed with a standard socket or spanner.

LEVEL 3:
Maximum Security

Can be installed and removed with the following tools:

Spanner

M10

PART NO.	DRIVE SIZE	LB/FT	SHEAR	NM	MATERIAL	\$/ea	\$/100
SHBM1025-A2	25mm	23 - 28		31 - 38	304 S/S	\$12.83	\$1,026.73
SHBM1050-A2	50mm	23 - 28		31 - 38	304 S/S	\$20.28	\$1,622.08

M12

PART NO.	DRIVE SIZE	LB/FT	SHEAR	NM	MATERIAL	\$/ea	\$/100
SHBM1225-A2	25mm	38 - 44		52 - 60	304 S/S	\$17.20	\$1,375.68
SHBM1260-A2	60mm	38 - 44		52 - 60	304 S/S	\$29.25	\$2,340.80

Ideal for high-security, permanent fixtures.

ARMOUR RING™



Simple collar which can be hammered over any standard hex.

Ultimate security - no tool for removal.

Can be applied to existing fasteners - ideal for upgrading security on an existing installation.

LEVEL 3:
Maximum Security



Can be installed and removed with the following tools:



Hammer



Setting Tool

See page 137 - For more details on Driver Tools

M6

PART NO.	SETTING TOOL	MATERIAL	\$/100
AR6-Z	ARST60	Zinc	\$172.60
AR6-S	ARST60	304 S/S	\$514.90

M8

PART NO.	SETTING TOOL	MATERIAL	\$/100
AR8-Z	ARST80	Zinc	\$218.40
AR8-S	ARST80	304 S/S	\$644.30

M10

PART NO.	SETTING TOOL	MATERIAL	\$/100
AR10-Z	ARST100	Zinc	\$305.80
AR10-S	ARST100	304 S/S	\$1,306.10

M12

PART NO.	SETTING TOOL	MATERIAL	\$/100
AR12-Z	ARST120	Zinc	\$600.08
AR12-S	ARST120	Stainless	\$1,632.06

M16

PART NO.	SETTING TOOL	MATERIAL	\$/100
AR16-Z	ARST160	Zinc	\$1,201.02
AR16-S	ARST160	304 S/S	\$7,207.02

M20

PART NO.	SETTING TOOL	MATERIAL	\$/100
AR20-S	ARST200	304 S/S	P.O.A.

We can supply broken packs just add 20%.
Contact Our Sales Team To Find Out More

Collar is tapped into place with conventional tools

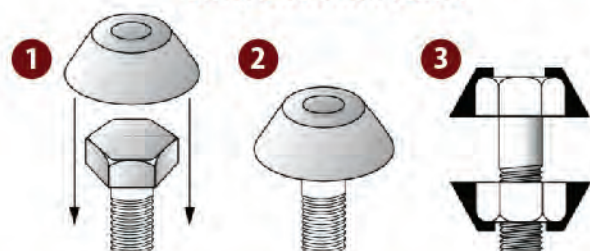

ARMOUR RING™ TO SUIT HEX WASHER FACE SCREW

Modified Armour Ring™ to make standard washer face roofing screws TAMPER EVIDENT.

Can be painted to match roof sheet colours.

Ultimate security - no tool for removal.

Can be applied to existing fasteners - ideal for upgrading security on an existing installation.

LEVEL 3:
Maximum Security

Can be installed and removed with the following tools:

Hammer

Setting Tool

See page 137 - For more details on Driver Tools



PART NO.	SETTING TOOL	MATERIAL	\$/100
AR5.5-M-G	ARST6C	Galvanised	\$365.00
AR5.5-M-A2	ARST6C	304 S/S	P.O.A.



PART NO.	SETTING TOOL	MATERIAL	\$/100
AR6-M-G	ARST6C	Galvanised	\$385.00
AR6-M-A2	ARST6C	304 S/S	P.O.A.

DIMENSIONS

SIZE / DIMENSIONS	M6	M8	M10	M12	M16	M20
Dimension A	15.8	20.0	26.6	33.0	41.2	51.0
Dimension B	10.9	14.2	18.6	20.8	26.7	33.5
Dimension C	7.2	10.5	12.0	13.5	17.3	20.0
Dimension D	6.8	7.7	9.8	12.3	16.0	19.0

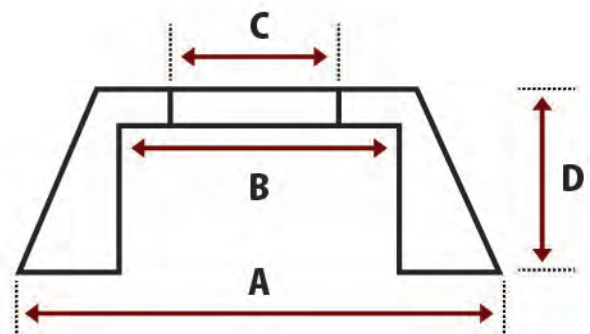

Collar is tapped into place with conventional tools



STELLAR NUTS

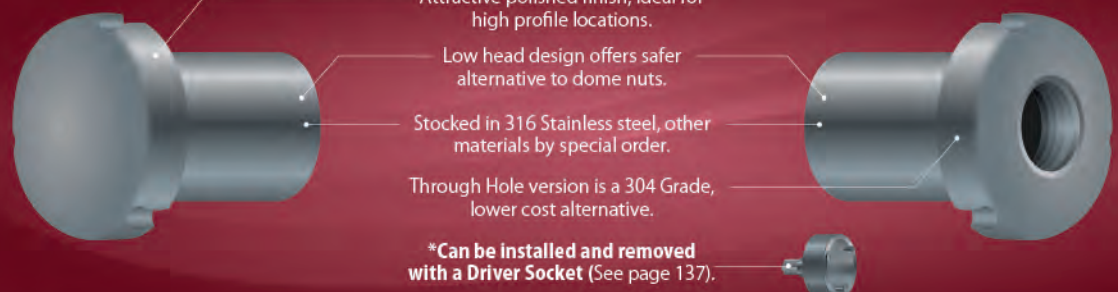

Attractive polished finish, ideal for high profile locations.

Low head design offers safer alternative to dome nuts.

Stocked in 316 Stainless steel, other materials by special order.

Through Hole version is a 304 Grade, lower cost alternative.

***Can be installed and removed with a Driver Socket (See page 137).**

LEVEL 2:
High Security



M12-SP



PART NO.	LENGTH	DRIVE SIZE	HEAD DIA	HEAD HEIGHT	MATERIAL	\$/ea	\$/100
SRBN1222SP	22mm	SRSM12SP	30mm	5mm	316 S/S	\$21.00	\$1,698.00

M12-TH



PART NO.	LENGTH	DRIVE SIZE	HEAD DIA	HEAD HEIGHT	MATERIAL	\$/ea	\$/100
SRBN1222TH	22mm	SRS12-1	30mm	5mm	304 S/S	\$16.80	\$1,350.00

STELLAR™ BARREL NUT DIMENSIONS

DESCRIPTION	MATERIAL	A	B	C	D
M12 BARREL NUT	304 S/S	30	22	18	5
DRIVER SOCKET	304 S/S	38	3/8"	40	15

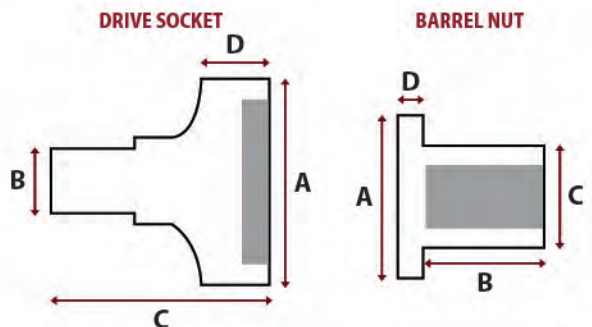

Provides Security and an Architectural finish.



SLAB TEE NUT

Useful threaded insert, often used in the playground industry.

No drive recess - offers complete security.

LEVEL 3:
Maximum Security



PART NO.	LENGTH	HEAD WIDTH	HEIGHT	MATERIAL	\$/100
STBTN10	9mm	26mm	1.8mm	304 S/S	\$150.00
STBTN3/8	9mm	25.5mm	1.8mm	304 S/S	\$180.00

TRIDENT NUT

Cone shape resists attack.

Available in a range of Imperial threadsizes.

Made in Zinc Alloy.

LEVEL 1:
Basic Security

Can be installed and removed with the following tools:

Socket

See page 135 - For more details on Driver Tools



PART NO.	THREAD SIZE	DRIVE SIZE	HEAD DIA	HEAD HEIGHT	MATERIAL	\$/100
TDN1024	10-24	TDS20	15.8mm	6.8mm	Zinc Alloy	\$225.00
TDN1032	10-32	TDS20	15.8mm	6.8mm	Zinc Alloy	\$225.00
TDNA20	1/4-20	TDS20	15.8mm	6.8mm	Zinc Alloy	\$265.00
TDNB18	5/16-18	TDS30	20.8mm	8.9mm	Zinc Alloy	\$375.00
TDNC16	3/8-16	TDS30	20.8mm	8.9mm	Zinc Alloy	\$440.00
TDNM10	M10	TSD40	15.8mm	8.9mm	Zinc Alloy	\$450.00
TDSD13	1/2-13	TSD40	24mm	8.9mm	Zinc Alloy	\$575.00

NO-GO SECURITY ENCLOSURE

Non Removable enclosure with Type 2 cap specially designed for nuts which have thread protruding.

Non Removable enclosure for any standard bolt or nut.

No specialist tools required - top cap is applied with a hammer.

Manufactured from case hardened steel.

LEVEL 3:
Maximum Security

Can be installed and removed with the following tools:

Hammer



PART NO.	MATERIAL	\$/ea	\$/100
NG5PR	Zinc	\$13.07	\$108.88
NG6PR	Zinc	\$13.65	\$113.75
NG8PR	Zinc	\$19.89	\$165.75
NG10PR	Zinc	\$30.23	\$251.88
NG12PR	Zinc	\$43.29	\$360.75

PART NO.	MATERIAL	\$/ea	\$/100
NG5PR-H	Zinc	\$13.07	\$108.88
NG6PR-H	Zinc	\$13.65	\$113.75
NG8PR-H	Zinc	\$19.89	\$165.75
NG10PR-H	Zinc	\$30.23	\$251.88
NG12PR-H	Zinc	\$43.29	\$360.75

DIMENSIONS

LENGTH	A	B	C	D	E	F ANGLE
M5	12	20	5.4	18	12.9	4.5
M6	13	22	6.4	20	15	5
M8	14	28.4	8.4	26	19.9	6
M10	18	32	10.4	30	25.3	6
M12	20	36	12.4	32	26.4	6

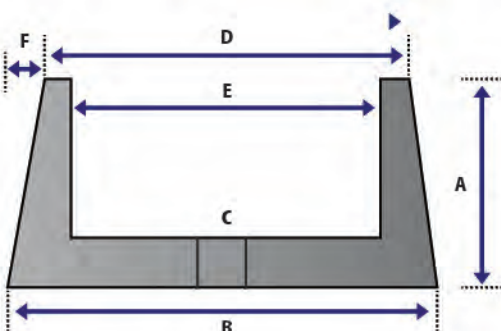

A. Fix base cap under fastener.



B. Hammer home cap for the most secure fastening.



PYRANUT

Easy to install, no special tools required.

Can be removed, see instructions below.

Stocked in zinc plated, hardened steel.

Imperial sizes also available by special order.

LEVEL 1:
Basic Security

Installation Instructions

- 1
- 2
- 3
- 4

M6

PART NO.	WIDTH	HEIGHT	MATERIAL	\$/ea	\$/100
PYNM6	26.7mm	5.8mm	Zinc	\$4.50	\$375.00

M8

PART NO.	WIDTH	HEIGHT	MATERIAL	\$/ea	\$/100
PYNM8	26.7mm	5.8mm	Zinc	\$4.50	\$375.00

M10

PART NO.	WIDTH	HEIGHT	MATERIAL	\$/ea	\$/100
PYNM10	26.7mm	5.8mm	Zinc	\$4.50	\$375.00

M12

PART NO.	WIDTH	HEIGHT	MATERIAL	\$/ea	\$/100
PYNM12	31.8mm	7.6mm	Zinc	\$7.50	\$625.00

SCROLL NUTS



Patented, High security nut.

Stocked in 304 grade stainless, can be custom made in 316 grade.

LEVEL 2:
High Security



Can be installed and removed with the following tools:



Driver Socket

See page 136 - For more details on Driver Tools



PART NO.	DRIVE SIZE	MATERIAL	\$/100
SCN3	SC3	304 S/S	\$1,382.00



PART NO.	DRIVE SIZE	MATERIAL	\$/100
SCN4	SC4	304 S/S	\$1,420.00



PART NO.	DRIVE SIZE	MATERIAL	\$/100
SCN5	SC5	304 S/S	\$1,450.00



PART NO.	DRIVE SIZE	MATERIAL	\$/100
SCN6	SC6	304 S/S	\$1,650.00



PART NO.	DRIVE SIZE	MATERIAL	\$/100
SCN8	SC8	304 S/S	\$1,695.00



PART NO.	DRIVE SIZE	MATERIAL	\$/100
SCN10	SC10	304 S/S	\$1,750.00



We can supply broken packs just add 20%.
Contact Our Sales Team To Find Out More

SCROLL NUTS



Patented, High security nut.

Stocked in 304 grade stainless, can be custom made in 316 grade.

LEVEL 2:
High Security



Can be installed and removed with the following tools:



Driver Socket

See page 136 - For more details on Driver Tools

M12



PART NO.	DRIVE SIZE	MATERIAL	\$/100
SCN12	SC12	304 S/S	\$1,960.00

M16



PART NO.	DRIVE SIZE	MATERIAL	\$/100
SCN16	SC16	304 S/S	\$3,575.00

M20



PART NO.	DRIVE SIZE	MATERIAL	\$/100
SCN20	SC20	304 S/S	\$4,555.00

M24



PART NO.	DRIVE SIZE	MATERIAL	\$/100
SCN24	SC24	304 S/S	\$5,525.00

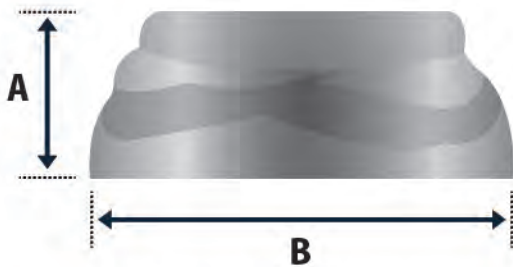

DIMENSIONS

THREADED SIZE		M3	M4	M5	M6	M8	M10	M12	M16	M20	M24
Scroll Nut Dimensions (mm)	A	3.4	3.4	4.3	4.8	6	7.5	9	12	12.8	14.3
	B	7.9	7.9	9.5	12.5	16	19	22	25	35	38

PATENTED BUTTON HEAD CONCRETE SCREW

Easy to install, high strength concrete anchor.

Low button head offers a safety benefit for pedestrian areas.

Suitable for solid concrete and hollow block applications.

6 Lobe drive for high torque installation.

Recess plug available to render this anchor non-removable.

LEVEL 3:
Maximum Security

Can be installed and removed with the following tools:

- Insert Bit
- Key Wrench
- Screwdriver

See page 134 - For more details on Driver Tools

8mm

Galv. 500 Hour SST

PART NO.	LENGTH	DRIVE SIZE	DRILL SIZE	MAX FIXTURE	HEAD DIA	HEAD HEIGHT	PULL OUT (kN)	SHEAR (kN)	\$/100
TBSB860	60mm	T30	6mm	10mm	16.7mm	4.9mm	7.6	14.1	\$145.00
TBSB880	80mm	T30	6mm	20mm	16.7mm	4.9mm	11.2	14.1	\$187.50
TBSB8100	100mm	T30	6mm	40mm	16.7mm	4.9mm	11.2	14.1	\$225.00
TBSB8120	120mm	T30	6mm	60mm	16.7mm	4.9mm	11.2	14.1	\$325.00

10mm

Galv. 500 Hour SST

PART NO.	LENGTH	DRIVE SIZE	DRILL SIZE	MAX FIXTURE	HEAD DIA	HEAD HEIGHT	PULL OUT (kN)	SHEAR (kN)	\$/100
TBSB1060	60mm	T40	8mm	10mm	21.6mm	5.1mm	9.2	23.4	\$360.00
TBSB1080	80mm	T40	8mm	10mm	21.6mm	5.1mm	15.6	23.4	\$395.00
TBSB10100	100mm	T40	8mm	30mm	21.6mm	5.1mm	15.6	23.4	\$475.00
TBSB10120	120mm	T40	8mm	50mm	21.6mm	5.1mm	15.6	23.4	\$497.50

Recess Plugs

Installation instructions on page 126

PART NO.	SIZE	\$/100
TP8G	T30 - To suit 6 & 8mm Anchors	\$48.50
TP10G	T40 - To suit 10mm Anchors	\$48.50

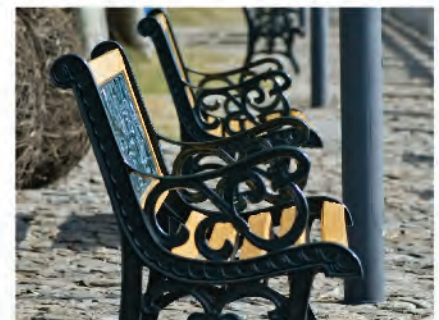

PATENTED COUNTERSUNK CONCRETE SCREW

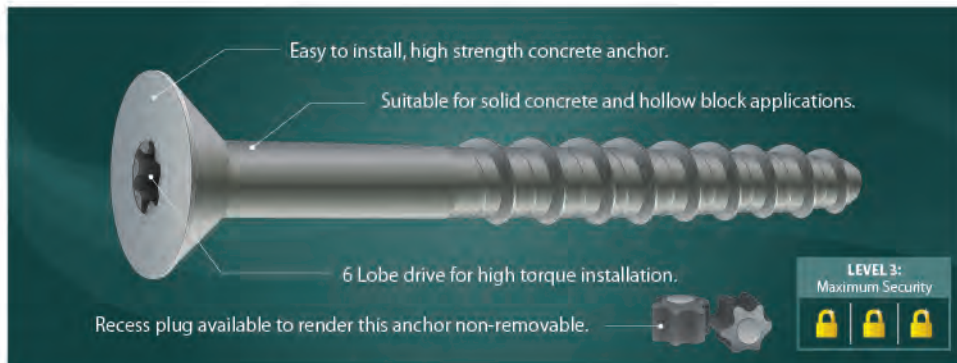

Galv. 500 Hour SST

PART NO.	LENGTH	DRIVE SIZE	DRILL SIZE	MAX FIXTURE	HEAD DIA	HEAD HEIGHT	PULL OUT (kN)	SHEAR (kN)	\$/100
TCSB660	60mm	T30	5mm	10mm	11.6mm	4.2mm	6.6	6.8	\$90.00
TCSB680	80mm	T30	5mm	30mm	11.6mm	4.2mm	6.6	6.8	\$112.00
TCSB6100	100mm	T30	5mm	50mm	11.6mm	4.2mm	6.6	6.8	\$178.00
TCSB6120	120mm	T30	5mm	70mm	11.6mm	4.2mm	6.6	6.8	\$190.00



Galv. 500 Hour SST

PART NO.	LENGTH	DRIVE SIZE	DRILL SIZE	MAX FIXTURE	HEAD DIA	HEAD HEIGHT	PULL OUT (kN)	SHEAR (kN)	\$/100
TCSB845	45mm	T30	6mm	5mm	15.8mm	6mm	6.8	14.1	\$126.00
TCSB860	60mm	T30	6mm	10mm	15.8mm	6mm	7.6	14.1	\$145.00
TCSB870	70mm	T30	6mm	10mm	15.8mm	6mm	11.2	14.1	\$160.00
TCSB880	80mm	T30	6mm	20mm	15.8mm	6mm	11.2	14.1	\$187.50
TCSB8100	100mm	T30	6mm	40mm	15.8mm	6mm	11.2	14.1	\$225.00
TCSB8120	120mm	T30	6mm	60mm	15.8mm	6mm	11.2	14.1	\$325.00
TCSB8140	140mm	T30	6mm	80mm	15.8mm	6mm	11.2	14.1	\$375.00

*Pull-out and Shear loads shown in the table are characteristic loads from tests run on non-cracked concrete C20/25 without edge and spacing effect. (Pull-out and shear loads are in kN; 1kN = 100 Kg) Characteristic loads can be used for Ultimate limited state design of anchorages for use in concrete according to ETAG001-Part C, or CEN/TS 1992-4-1 : 2009. In cases of concrete with a strength class lower than C20/25, or in case of further types of heavy masonry or stone, additional and special tests before installation are required.

PATENTED COUNTERSUNK CONCRETE SCREW

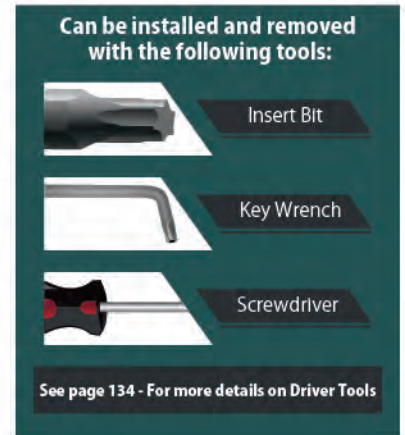
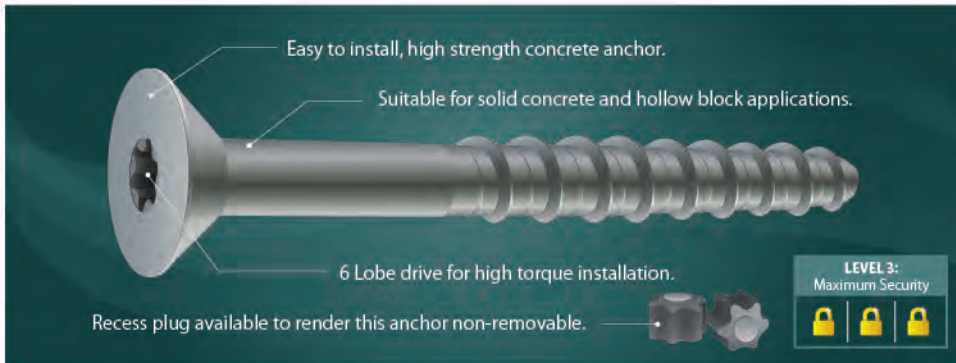

PART NO.	LENGTH	DRIVE SIZE	DRILL SIZE	MAX FIXTURE	HEAD DIA	HEAD HEIGHT	PULL OUT (kN)	SHEAR (kN)	\$/100
TCSB1080	80mm	T40	8mm	10mm	19.8mm	7.2mm	15.6	23.4	\$375.00
TCSB10100	100mm	T40	8mm	30mm	19.8mm	7.2mm	15.6	23.4	\$395.00
TCSB10120	120mm	T40	8mm	50mm	19.8mm	7.2mm	15.6	23.4	\$497.50
TCSB10140	140mm	T40	8mm	70mm	19.8mm	7.2mm	15.6	23.4	\$622.00
TCSB10160	160mm	T40	8mm	90mm	19.8mm	7.2mm	15.6	23.4	\$762.00



PART NO.	LENGTH	DRIVE SIZE	DRILL SIZE	MAX FIXTURE	HEAD DIA	HEAD HEIGHT	PULL OUT (kN)	SHEAR (kN)	\$/100
TCSB12100	100mm	T50	10mm	20mm	23.8mm	8.4mm	24.4	30.6	\$550.00
TCSB12120	120mm	T50	10mm	40mm	23.8mm	8.4mm	24.4	30.6	\$650.00
TCSB12140	140mm	T50	10mm	60mm	23.8mm	8.4mm	24.4	30.6	\$875.00
TCSB12180	180mm	T50	10mm	100mm	23.8mm	8.4mm	24.4	30.6	\$1,485.00

WANT TO MAKE THESE ANCHORS NON REMOVABLE?

It's easy as ABC! Add our optional recess plug as below

A: Install anchor as required

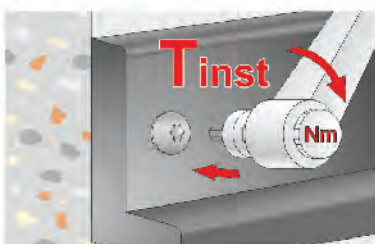

B: Locate pin plug in the recess

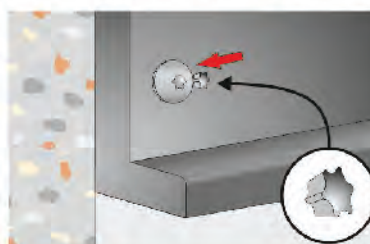

C: Tap plug until firmly seated

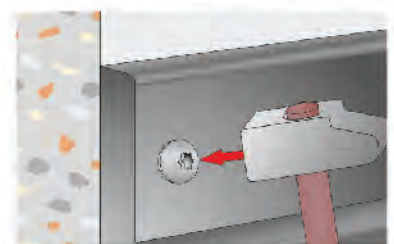

FASTDRIVE™ CONCRETE ANCHORS

Hammer-in Security anchor for concrete, very fast and easy to install and cannot be removed.

With 100% contact, Fastdrives create compressive strength which provides superior holding power.

No special tools required for installation.

LEVEL 3;
Maximum Security

Can be installed with the following tools:

Hammer



PART NO.	LENGTH	HEAD DIA	HEAD HEIGHT	MATERIAL	S/100
FDCA530	30mm	11.2mm	3mm	Galvanised	\$32.50
FDCA540	40mm	11.2mm	3mm	Galvanised	\$39.20
FDCA550	50mm	11.2mm	3mm	Galvanised	\$47.50
FDCA565	65mm	11.2mm	3mm	Galvanised	\$53.20
FDCA575	70mm	11.2mm	3mm	Galvanised	\$65.40
FDCA585	80mm	11.2mm	3mm	Galvanised	\$139.00
FDCA5100	100mm	11.2mm	3mm	Galvanised	\$118.90

FASTDRIVE™ TECHNICAL DATA

DRILL SIZE	Total Length	Minimum Embedment	Maximum Fixing Thickness	Clearance Hole Size
5	30mm	25mm	5mm	6.5mm
5	40mm	25mm	15mm	6.5mm
5	50mm	30mm	20mm	6.5mm
5	65mm	30mm	35mm	6.5mm
5	75mm	30mm	45mm	6.5mm
5	85mm	30mm	55mm	6.5mm
5	100mm	30mm	70mm	6.5mm

30 MPA CONCRETE

Embedment Depth mm	Ultimate Tension (Kn)	Ultimate Shear (Kn)
20	5.4	8.2
25	7.4	13.8
32	10.6	14.9

1 Drill a 5mm diameter hole to the recommended minimum depth and clean hole.

2 Insert Fastdrive™ through material to be fastened and drive with a hammer until head is flush.

RESYTORK BUTTON HEAD REMOVABLE SLEEVE ANCHORS

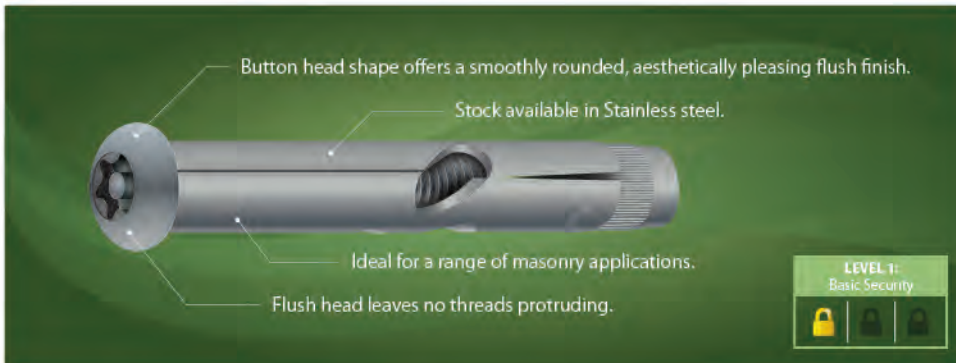

Can be installed and removed with the following tools:

- Insert Bit
- Key Wrench
- Screwdriver

See page 134 - For more details on Driver Tools



PART NO.	LENGTH	DRIVE SIZE	HEAD DIA	HEAD HEIGHT	DRILL DIA	MATERIAL	\$/100
RTBSA845	45mm	T30	10.3mm	3.2mm	8mm	304 S/S	\$845.00



PART NO.	LENGTH	DRIVE SIZE	HEAD DIA	HEAD HEIGHT	DRILL DIA	MATERIAL	\$/100
RTBSA1055	55mm	T40	13.7mm	4.5mm	10mm	304 S/S	\$1,112.00
RTBSA1075	75mm	T40	13.7mm	4.5mm	10mm	304 S/S	\$1,568.00



PART NO.	LENGTH	DRIVE SIZE	HEAD DIA	HEAD HEIGHT	DRILL DIA	MATERIAL	\$/100
RTBSA1265	65mm	T45	17.3mm	5.3mm	12mm	304 S/S	\$1,614.00
RTBSA1280	80mm	T45	17.3mm	5.3mm	12mm	304 S/S	\$2,006.00

We can supply broken packs just add 20%.
Contact Our Sales Team To Find Out More

RESYTORK COUNTERSUNK REMOVABLE SLEEVE ANCHORS

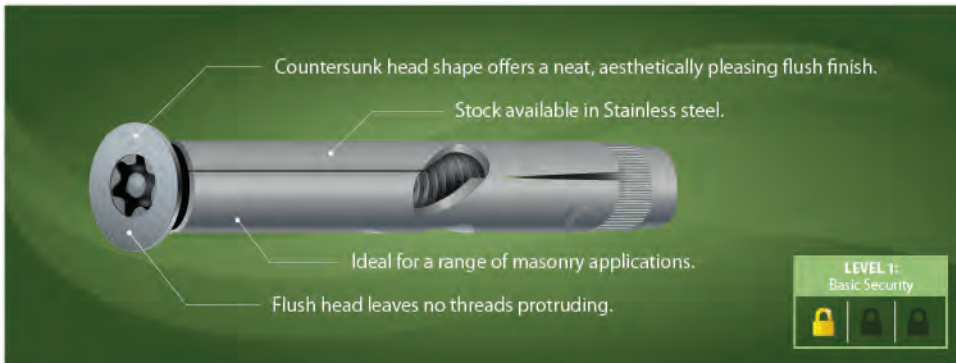

Can be installed and removed with the following tools:

- Insert Bit
- Key Wrench
- Screwdriver

See page 134 - For more details on Driver Tools



PART NO.	LENGTH	DRIVE SIZE	HEAD DIA	HEAD HEIGHT	DRILL DIA	MATERIAL	\$/100
RTCSA850	50mm	T30	11.8mm	3.3mm	8mm	304 S/S	\$870.00



PART NO.	LENGTH	DRIVE SIZE	HEAD DIA	HEAD HEIGHT	DRILL DIA	MATERIAL	\$/100
RTCSA1055	55mm	T40	14mm	4.7mm	10mm	304 S/S	\$1,042.00
RTCSA1080	80mm	T40	14mm	4.7mm	10mm	304 S/S	\$1,600.00



PART NO.	LENGTH	DRIVE SIZE	HEAD DIA	HEAD HEIGHT	DRILL DIA	MATERIAL	\$/100
RTCSA1260	60mm	T45	17.3mm	5.2mm	12mm	304 S/S	\$1,646.00
RTCSA1280	80mm	T45	17.3mm	5.2mm	12mm	304 S/S	\$2,048.00



KINMAR REMOVABLE SLEEVE ANCHORS



Unique Kinmar® Drive offers accurate, torque controlled fixing, which can be retorqued or removed if necessary.

Available in Zinc plated, Galvanised and Stainless steel.

Suitable for a range of masonry applications, including solid concrete, block and brick.

LEVEL 2:
High Security



Can be installed and removed with the following tools:



Drive Socket



See page 136 - For more details on Driver Tools

8mm



PART NO.	LENGTH	DRIVE SIZE	DRILL SIZE	MAX FIXTURE	MATERIAL	\$/ea	\$/100
KMRSS840	40mm	KM6R	8mm	5mm	Galvanised	\$7.92	\$660.00
KMRSS865	65mm	KM6R	8mm	30mm	Galvanised	\$8.47	\$706.09
KMRSS885	85mm	KM6R	8mm	50mm	Galvanised	\$9.45	\$787.16

10mm

PART NO.	LENGTH	DRIVE SIZE	DRILL SIZE	MAX FIXTURE	MATERIAL	\$/ea	\$/100
KMRSS1040	40mm	KM8R	10mm	6mm	Galvanised	\$9.38	\$781.88
KMRSS1050	50mm	KM8R	10mm	10mm	Galvanised	\$9.77	\$814.00
KMRSS1060	60mm	KM8R	10mm	20mm	Galvanised	\$9.77	\$814.00
KMRSS1075	75mm	KM8R	10mm	35mm	Galvanised	\$10.16	\$847.00
KMRSS1095	95mm	KM8R	10mm	55mm	Galvanised	\$12.09	\$1,007.60

12mm



PART NO.	LENGTH	DRIVE SIZE	DRILL SIZE	MAX FIXTURE	MATERIAL	\$/ea	\$/100
KMRSG1260	60mm	KM10R	12mm	10mm	Galvanised	\$12.94	\$1,078.00
KMRSG1275	75mm	KM10R	12mm	25mm	Galvanised	\$14.32	\$1,193.50
KMRSG12100	100mm	KM10R	12mm	50mm	Galvanised	\$15.25	\$1,271.05
KMRSG12130	130mm	KM10R	12mm	80mm	Galvanised	\$16.24	\$1,353.00

KINMAR PERMANENT SLEEVE ANCHORS

Unique Kinmar® Drive offers accurate, torque controlled fixing, which can be retorqued if necessary.

High security non-removable anchor.

Available in Zinc plated, Galvanised and Stainless steel.

Suitable for a range of masonry applications, including solid concrete, block and brick.

LEVEL 3:
 Maximum Security

Can be installed and removed with the following tools:

Drive Socket

See page 136 - For more details on Driver Tools

8mm

PART NO.	LENGTH	DRIVE SIZE	DRILL SIZE	MAX FIXTURE	MATERIAL	\$/ea	\$/100
KMSG0840	40mm	KM6P	8mm	5mm	Galvanised	\$7.92	\$660.00
KMSG0865	65mm	KM6P	8mm	30mm	Galvanised	\$8.47	\$706.09
KMSG0885	85mm	KM6P	8mm	50mm	Galvanised	\$9.45	\$787.16

10mm

PART NO.	LENGTH	DRIVE SIZE	DRILL SIZE	MAX FIXTURE	MATERIAL	\$/ea	\$/100
KMSG1040	40mm	KM8P	10mm	6mm	Galvanised	\$8.84	\$737.00
KMSG1050	50mm	KM8P	10mm	10mm	Galvanised	\$9.38	\$781.77
KMSG1060	60mm	KM8P	10mm	20mm	Galvanised	\$9.77	\$814.00
KMSG1075	75mm	KM8P	10mm	35mm	Galvanised	\$10.16	\$847.00
KMSG1095	95mm	KM8P	10mm	55mm	Galvanised	\$12.09	\$1,007.60

12mm

PART NO.	LENGTH	DRIVE SIZE	DRILL SIZE	MAX FIXTURE	MATERIAL	\$/ea	\$/100
KMSG1260	60mm	KM10P	12mm	10mm	Galvanised	\$12.94	\$1,078.00
KMSG1275	75mm	KM10P	12mm	25mm	Galvanised	\$14.32	\$1,193.50
KMSG12100	100mm	KM10P	12mm	50mm	Galvanised	\$15.25	\$1,271.05
KMSG12130	130mm	KM10P	12mm	80mm	Galvanised	\$16.24	\$1,353.00

FOUR HOLE NUT & BOLT SYSTEM

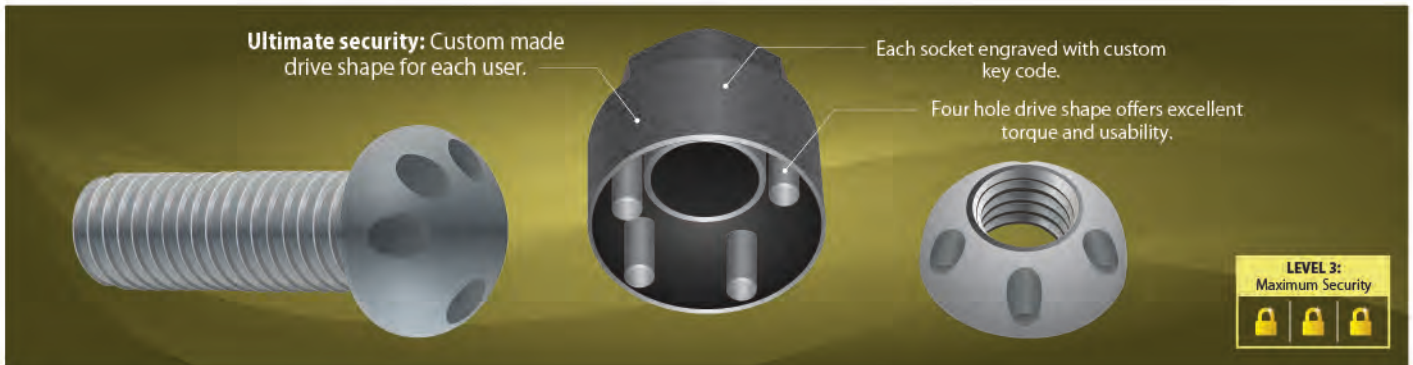

FOUR HOLE NUTS

MADE TO ORDER IN METRIC AND IMPERIAL THREAD TYPES.

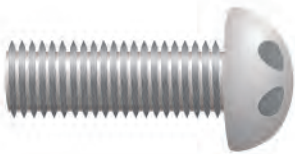

FOUR HOLE BOLTS

MADE TO ORDER IN METRIC AND IMPERIAL THREAD TYPES.



FOUR HOLE SOCKETS

MADE TO SUIT FOR FOUR HOLE BOLTS & NUTS

DRIVING LIGHT ANTI THEFT KITS

STANDARD DRIVER CONFIGURATION



PART NO.	THREAD SIZE	KIT CONTAINS	MATERIAL	\$/Kit
FHNM8-KIT	M8	1 Socket, 2 x nuts	Zinc plated	\$60.00
FHNM10-KIT	M10	1 Socket, 2 x nuts	Zinc plated	\$62.50
FHNM12-KIT	M12	1 Socket, 2 x nuts	Zinc plated	\$70.00
FHNM1/2BSW-KIT	1/2BSW	1 Socket, 2 x nuts	Zinc plated	\$85.00

ON GOING USE? SPEAK TO OUR SALES TEAM ABOUT OUR STOCK HOLDING AND PACKAGING CAPABILITIES.

TRI HEAD SECURITY SCREWS

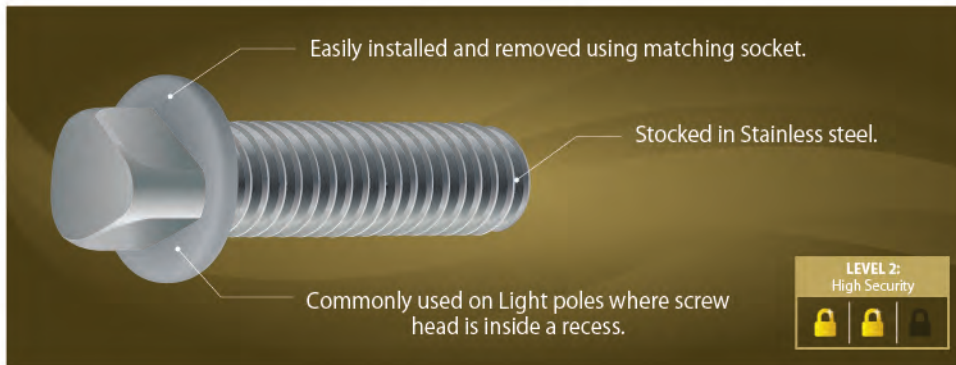

Can be installed with the following tools:

Key Wrench

See page 137 - For more details on Driver Tools



PART NO.	LENGTH	DRIVE SIZE	HEAD DIA	HEAD HEIGHT	MATERIAL	\$/100
TRWM820	20mm	TRI-8	13.7mm	8mm	304 S/S	\$450.00
TRWM830	30mm	TRI-8	13.7mm	8mm	304 S/S	\$490.50
TRWM840	40mm	TRI-8	13.7mm	8mm	304 S/S	\$526.50
TRWM850	50mm	TRI-8	13.7mm	8mm	304 S/S	\$565.50



RESYTORK



1/4" x 65mm Hex Insert Bit T-20 & T-30 Double ended

Part No.	\$/ea
T2030-B	\$15.00



1/4" Hex Insert Bit x 75mm

Part No.	\$/ea
T575-B	\$13.60
T675-B	\$13.60
T775-B	\$13.60
T875-B	\$13.60
T975-B	\$13.60
T1075-B	\$13.60
T1575-B	\$13.60
T2075-B	\$13.60
T2575-B	\$13.60
T2775-B	\$13.60
T3075-B	\$13.60



Resytork 'L' key wrench

Part No.	\$/ea
T10-K	\$13.00
T15-K	\$13.00
T20-K	\$13.00
T25-K	\$13.00
T27-K	\$23.90
T30-K	\$23.90
T40-K	\$23.90
T45-K	\$23.90



1/4" Hex Insert Bit x 25mm

Part No.	\$/ea
T6-B	\$9.90
T7-B	\$9.90
T8-B	\$9.90
T9-B	\$9.90
T10-B	\$9.90
T15-B	\$9.90
T20-B	\$9.90
T25-B	\$9.90
T27-B	\$9.90
T30-B	\$9.90
T40-B	\$9.90
T45-B	\$9.90
T50-B	\$9.90



1/4" Hex Insert Bit x 50mm

Part No.	\$/ea
T1050-B	\$12.00
T1550-B	\$12.00
T2050-B	\$12.00
T2550-B	\$12.00
T2750-B	\$12.00
T3050-B	\$12.00

**We also sell these tools in kits
See page 138**

RESYTORK SCREWDRIVER



One Piece Screwdriver

Part No.	\$/ea
T5-SD	\$22.50
T6-SD	\$22.50
T7-SD	\$22.50
T8-SD	\$22.50
T9-SD	\$22.50
T10-SD	\$27.50

Part No.	\$/ea
T15-SD	\$27.50
T20-SD	\$27.50
T25-SD	\$27.50
T27-SD	\$27.50
T30-SD	\$27.50
T40-SD	\$27.50
T45-SD	\$27.50

STANDARD TORK



1/4" Hex Insert Bit x 25mm

Part No.	\$/ea
T20-S	\$2.50
T25-S	\$2.50
T30-S	\$2.50
T40-S	\$2.50

TORXplus®



1/4" Hex Insert Bit x 25mm

Part No.	\$/ea
10 IPR	\$57.00
15 IPR	\$57.00
20 IPR	\$57.00
25 IPR	\$57.00
27 IPR	\$57.00
30 IPR	\$57.00

PENTAFORCE™



1/4" Hex Insert Bit

Part No.	\$/ea
PFD0-B (50mm)	\$24.00
PFD1-B (50mm)	\$24.00
PFD1150-B (150mm)	\$36.00
PFD2-B (50mm)	\$28.00
PFD3-B (50mm)	\$32.00
PFD000-B (50mm)	\$24.00
PFD00-B (50mm)	\$24.00



Allen Key

Part No.	\$/ea
PFD000-K	\$30.00
PFD00-K	\$30.00
PFD0-K	\$32.00
PFD1-K	\$34.00
PFD2-K	\$38.00

PIN PHILLIPS



1/4" Hex Insert Bit x 25mm

Part No.	\$/ea
PP2-B	\$18.00
PP3-B	\$18.00

TRIDENT SOCKET



Part No.	\$/ea
TDS20	\$120.00
TDS30	\$140.00
TDS40	\$400.00

STANDARD MAGNETIC SCREWDRIVER



Part No.	\$/ea
RMH	\$45.60

Reversible silent ratchet magnetic screwdriver. Storage area in handle and 1/4" hex drive for interchangeable bits.

STANDARD MAGNETIC SCREWDRIVER



Part No.	\$/ea
SMH	\$34.20

With storage area in handle and 1/4" hex drive for interchangeable bits.

CLUTCH HEAD REMOVAL TOOL



For use with Clutch Head screws only. The two tungsten carbide tips dig into the sloping areas of the Clutch Head and enable removal when applying pressure.

Part No.	\$/ea
RT41: Suitable for 6G screws	\$69.00
RT51: Suitable for 8G, 10G & 12G screws	\$69.00
RT61: Suitable for 14G screws	\$69.00

CLUTCH HEAD INSTALLATION TOOL



1/4" Hex Insert Bit

Part No.	\$/ea
SLD525 (25mm)	\$3.50
SLD550 (25mm)	\$5.20
SLD850 (50mm)	\$6.50
SLD1050 (50mm)	\$7.50

DRIVE BIT EXTENSION BIT HOLDER



Part No.	\$/ea
DBEH60	\$10.00

QUADTECH™



Part No.	\$/ea
SD2-B	\$18.00

1/4" Hex Insert Bit x 50mm

KINMAR® PERMANENT

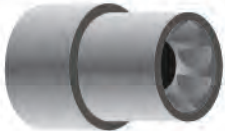

1/2" Square Drive Socket

Part No.	\$/ea
KM5P	\$82.40
KM6P	\$82.40
KM8P	\$82.40
KM10P	\$110.00
KM12P	\$128.00

KINMAR® REMOVABLE



1/2" Square Drive Socket

Part No.	\$/ea
KM5R	\$82.40
KM6R	\$82.40
KM8R	\$82.40
KM10R	\$110.00
KM12R	\$128.00

TRI-LOBULAR



1/4" Hex Insert Bit - Suits 10 Gauge

Part No.	\$/ea
TL2-B Suits 10G	\$9.90
TL2100-B (100mm) Suits 10G	\$21.70
TL10-B Suits M10	\$18.00



8mm Hex Insert Bit - Suits 10 Gauge



8mm Trilobe "L" key wrench (Double Ended)

Part No.	\$/ea
TL10-K	\$28.00

SCROLL™ NUT



Driver Socket

Part No.	\$/ea
SC3	\$245.70
SC4	\$245.70
SC5	\$273.00
SC6	\$307.13
SC8	\$341.25
SC10	\$375.38
SC12	\$409.50
SC16	\$477.75
SC20	\$614.25
SC4	\$682.50

2 HOLE



1/4" Hex insert bit
x 25mm

Size	Part No.	\$/ea
#4	TH3-B	\$9.90
#6	TH4-B	\$9.90
#8	TH5-B	\$9.90
#10	TH6-B	\$9.90
#12	TH7-B	\$9.90
#14	TH8-B	\$9.90

ARMOUR RING™



Setting Tool

Part No.	\$/ea
ARST6C	\$198.00
ARST6O	\$198.00
ARST8O	\$198.00

Part No.	\$/ea
ARST10O	\$198.00
ARST12O	\$198.00
ARST16O	\$298.00

OVAL PAN HEAD



1/4" Hex Insert Bit x 25mm

Part No.	\$/ea
PHD1	\$99.00
PHD2	\$99.00

STELLAR®



Driver Socket

Part No.	\$/ea
SRSM12SP	\$124.00
SRS12-1	\$124.00

TRIHEAD



Allen Key to suit Tri Head Security screws.

Part No.	\$/ea
TRI8-K	\$72.50

PIN HEX



1/4" Hex Insert Bit x 25mm

Hex Size	Part No.	\$/ea
3/32"	H20-B	\$9.90
1/8"	H30-B	\$9.90
5/32"	H40-B	\$9.90
5.0mm	H50-B	\$15.00
6.0mm	H60-B	\$25.00
8.0mm	H80-B	\$25.00
3/16"	H3/16-B	\$9.90
7/32"	H7/32-B	\$9.90

2.0mm	H2M-B	\$9.90
2.5mm	H25M-B	\$9.90
3.0mm	H3M-B	\$9.90
4.0mm	H4M-B	\$9.90



1/4" Hex Insert Bit x 50mm

Hex Size	Part No.	\$/ea
3/32"	H2050-B	\$12.00
1/8"	H3050-B	\$12.00
5/32"	H4050-B	\$12.00



1/4" Hex Insert Bit x 70mm

Hex Size	Part No.	\$/ea
5/32"	H4070-B	\$12.00



Pin Hex 'L' key wrench

Hex Size	Part No.	\$/ea
3/32"	H20-K	\$9.90
1/8"	H30-K	\$9.90
5/32"	H40-K	\$9.90
5.0mm	H50-K	\$15.00
6.0mm	H60-K	\$25.00
8.0mm	H80-K	\$25.00
10.0mm	H100-K	\$75.00
3/16"	H3/16-K	\$9.90
7/32"	H7/32-K	\$9.90
2.0mm	H2M-K	\$9.90
2.5mm	H25M-K	\$9.90
3.0mm	H3M-K	\$9.90

RESYTORK DRIVER PACK 1



Part No.	\$/ea
RTDP1	\$70.00

(25mm Bits) 10 Pce
Contains: T8-B, T9-B, T10-B, T15-B, T20-B,
T25-B, T27-B, T30-B, T40-B, T45-B.

RESYTORK DRIVER PACK 2



Part No.	\$/ea
RTDP2	\$118.75

(75mm Bits) 10 Pce
Contains: T575-B, T675-B, T775-B, T875-B, T975-B,
T1075-B, T1575-B, T2075-B, T2575-B, T3075-B.

SECURITY TOOL SET



- 33 Pce Security bit set
- 32 x 25mm Driver bits, with bit holder
- 9 x Resytork bits: T8, T10, T15, T20, T25, T27, T30, T35, T40
- 4 x 2 Hole bits: #4, #6, #8, #10
- 12 x Pin Hex bits: 5/64", 3/32", 7/64", 1/8", 9/64", 5/32", 2mm, 2.5mm, 3mm, 4mm, 5mm, 6mm
- 3 x TORQ bits: #6, #8, #10
- 4 x Phillips bits: #0, #1, #2, #3
- 1 x 54mm Drive bit holder

Part No.	\$/ea
SBK33	\$31.25



Part No.	\$/ea
SBK100	\$56.25

- 100 Pce Security bit set
- 9 x Resytork bits: T8, T10, T15, T20, T25, T27, T30, T35, T40
- 9 x Solid Torx bits: T8, T10, T15, T20, T25, T27, T30, T40, T45
- 12 x Pin Hex bits: 5/64", 3/32", 7/64", 1/8", 9/64", 5/32", 2mm, 2.5mm, 3mm, 4mm, 5mm, 6mm
- 19 x Solid Hex bits: 1/16, 5/64", 3/32", 7/64", 1/8", 9/64", 5/32", 3/16", 7/32", 1/4", 1.5mm, 2mm, 2.5mm, 3mm, 4mm, 5mm, 5.5mm, 6mm, 8mm
- 4 x Triwing Bits: #1, #2, #3, #4
- 3 x TORQ bits: #6, #8, #10
- 4 x 2 Hole bits: #4, #6, #8, #10
- 8 x Phillips bits: #0, #1, #2(x5), #3
- 8 x Pozi bits: #0, #1, #2(x5), #3
- 9 x Slotted bits: #3, #4, #4.5, #5, #5.5, #6, #6.5 #7, #8
- 4 x Square bits: #0, #1, #2, #3
- 3 x Spline Drive: 5,6,8
- 3 x Clutch Drive: 1,2,3
- 5 x Adaptors





600w x 1200h - Free Standing or Wall Mount

MERCHANDISER STAND

Boost your sales with this eye catching merchandiser stand. Stocked with our most popular selection (Retail value of \$1800).

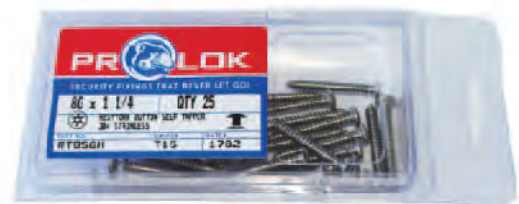

Merchandiser Clam Pack



Resytork Button Head Self Tappers with Driver to suit

PART NO.	DESCRIPTION	DRIVER	QTY	\$/PACK
RTBS6D-25	6G x 1/2"	T10	25 x 2	\$30.85
RTBS8F-25	8G x 3/4"	T15	25 x 2	\$34.60
RTBS8G-25	8G x 1"	T15	25 x 2	\$37.85
RTBS8H-25	8G x 1 1/4"	T15	25 x 2	\$39.55
RTBS10G-25	10G x 1"	T25	25 x 2	\$43.25
RTBS10I-25	10G x 1 1/2"	T25	25 x 2	\$52.38
RTBS12J-20	12G x 2"	T27	20 x 1	\$61.94
RTBS12K-20	12G x 2 1/2"	T27	20 x 1	\$70.20



Resytork Countersunk Self Tappers with Driver to suit

PART NO.	DESCRIPTION	DRIVER	QTY	\$/PACK
RTCS8F-25	8G x 3/4"	T20	25 x 2	\$34.60
RTCS8G-25	8G x 1"	T20	25 x 2	\$37.85
RTCS8I-25	8G x 1 1/2"	T20	25 x 2	\$45.55
RTCS10G-25	10G x 1"	T25	25 x 2	\$43.25
RTCS10I-25	10G x 1 1/2"	T25	25 x 2	\$52.38
RTCS12J-20	12G x 2"	T27	25 x 1	\$61.94



Resytork Button Head Machine Screws with Driver to suit

PART NO.	DESCRIPTION	DRIVER	QTY	\$/PACK
RTBM412-25	M4 x 12mm	T20	25 x 2	\$29.80
RTBM516-25	M5 x 16mm	T25	25 x 2	\$37.85
RTBM520-25	M5 x 20mm	T25	25 x 2	\$39.08
RTBM616-25	M6 x 16mm	T30	25 x 2	\$36.73
RTBM620-25	M6 x 20mm	T30	25 x 2	\$38.85
RTBM625-25	M6 x 25mm	T30	25 x 2	\$43.13
RTBM630-25	M6 x 30mm	T30	25 x 2	\$45.35



Clutch Head Round Head Self Tappers

PART NO.	DESCRIPTION	QTY	\$/PACK
CHRS8F-25	8G x 3/4"	25 x 2	\$12.76
CHRS10F-25	10G x 3/4"	25 x 2	\$15.68
CHRS10I-25	10G x 1 1/2"	25 x 2	\$20.09



Clutch Head Round Head Machine Screws

PART NO.	DESCRIPTION	QTY	\$/PACK
CHRM620-Z-25	M6 x 20mm Zinc	25 x 2	\$11.25



Shear Nuts

PART NO.	DESCRIPTION	QTY	\$/PACK
SHN6-Z-10	M6 - Zinc	10 x 1	\$15.00
SHN8-Z-10	M8 - Zinc	10 x 1	\$16.00
SHN10-Z-10	M10 - Zinc	10 x 1	\$21.00

DISTRIBUTORS:
Ask for your special discount
on this merchandisers

MADE TO MEASURE

SPECIALS

Sentinel Group are able to offer a made to measure range of Security Fasteners. Our expert sales team are able to assist with every type of security application from design stage to final installation, including on-site testing.

Design

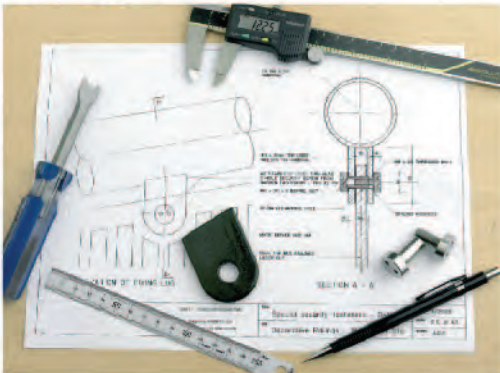

Manufacturer

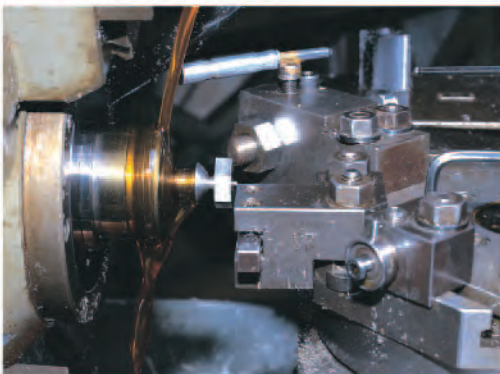

On-site Testing



Installation



Security



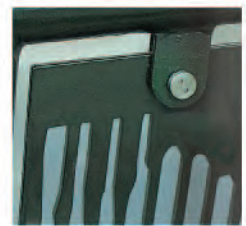

Safety



Make it harder for the intruder!



Placing fasteners in tight corners makes access for impulse tampering harder.

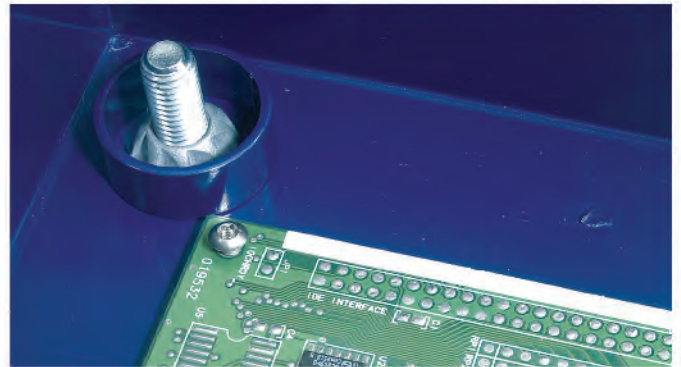

Placing fasteners in a recess further raises the level of security.



Mixing of driver types makes it much harder for intrusion.



By using our rubber plugs you can seal the fastener recess from dirt and also hide the driver type. To order only.



A. Can't find the size of screw you need?



For a security coach screw use an Armour Ring™ on the hexagon head.



B. Can you get it in a standard hex head? if so, you could use an **Amroun Ring™**.



C. Want security on both sides? You could use a standard cup head with a security nut.



D. How about using a length of studding with a security nut?



Or use a barrel nut each end for a neat finish with threads enclosed.

Do you deal with the following?

Government

- Local Councils
- Parks & Gardens
- Dept. of Defence
- Dept. of Correctional Services
- Hospitals
- Museums / Art Galleries
- Police Dept.
- Schools & Universities



Construction

- Prison Constructions
- Alarm Installers
- Public Toilets / Street Furniture Installation
- Airport / Railway Stations / Bus Terminals
- Stadium
- Handrails / Balustrading
- External Lighting



Manufacturing / Industrial

- Playground Manufacturers
- Street Furniture / Bus Shelter Manufacturers
- Vending Machine Manufacturers
- Electronics Industry
- Boom Gate / Security Fencing Manufacturers
- Marine / Boat Builders
- Sign Manufacturers
- Train & Bus Builders
- Auto Industry
- Shop Fitters
- Utilities Providers
- Window Screen Manufacturers
- Machine Safety Guard
- Solar Panel Manufacturers and Installers

“Tell them about Security Fixings”

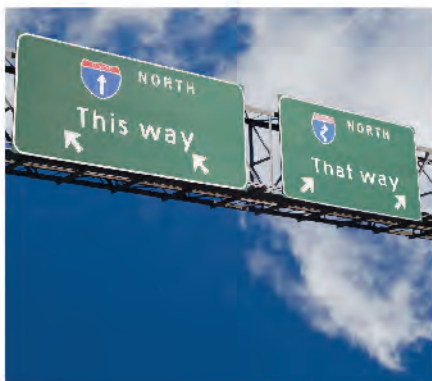
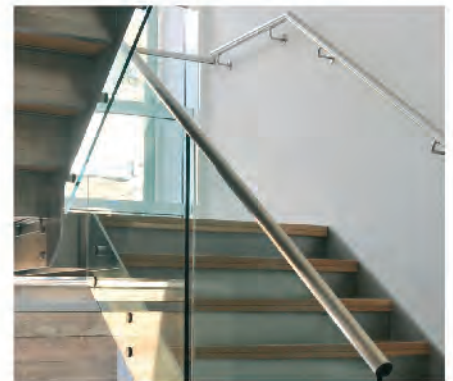

PROMOTIONAL ORDER FORM

PLEASE FILL OUT THE FORM AND FAX TO: 03 54442200

No.	Description	QTY Required
1	Prolok Ed. 5 Catalogue	
2	Prolok Sample board	
3	Prolok Sample case	
4	Security Screwbolts sample case	
5	Pentaforce sample case	
6	Digital version of Ed.5 catalogue (Includes Excel pricelist)	
7	Prolok DL flyer	
8	Prolok Store poster	
9	Security Screwbolts flyer	
10	Kinmar Bolts flyer	
11	Kinmar Nuts flyer	
12	Pentaforce REAL SECURITY flyer	
13	Uni-Set ULTIMATE SECURITY flyer	
14	Pentaforce SDS and Type 17 flyer	
15	Pentadrive flyer	
16	Resytork Barrel Nuts flyer	
17	Stellar Fixing Systems flyer	
18	Shear Bolts flyer	
19	No-Outs flyer **Due XYW 2014	
20	Merchandiser Stands flyer *Due XYW 2015	
21	Target Industries list	
22	PowerPoint Presentation USB	
23	Stainless Threadforming Screws flyer	
24	Stainless Square Drive Screws flyer	
25	Stainless Decking Screws flyer	

Date Requested: _____ **Contact:** _____

Company Name: _____

Address: _____

Please return by fax to: 03 5444 2200 or email to sales@sentinelgrp.com.au

1. Prolok Catalogue



2. Sample Board



3. Prolok sample case



4. Screwbolt sample case



5. Pentaforce sample case



6. Digital version Ed.5 catalogue



7. Prolok DL Flyer



8. Store poster



9. Screwbolt flyer



10. Kinmar bolts flyer



11. Kinmar Nuts flyer



12. Pentaforce REAL SECURITY



13. UniSet Ultimate security



14. Pentaforce SDS and t17



15. Pentadrive



16. Resytork Barrel Nuts



17. Stellar Fixing systems

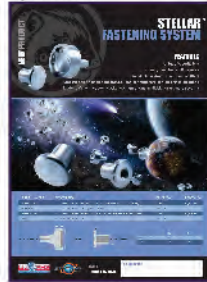

18. Shear Bolts



19. Tamper Evident Roofing screws flyer

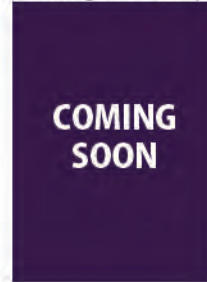

20. Merchandiser stands flyer

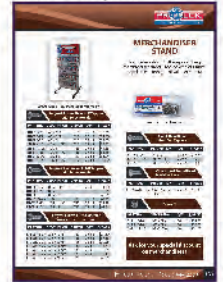

21. Target industries list



22. Powerpoint presentation



23. Stainless Thread-forming screw



24. Stainless Square drive screws



25. Decking screws



Recommended Drill Sizes for AB Type Self Tapping Screws into Metal

SCREW SIZE		PLATE GAUGE	DRILL OR PUNCHED; HOLE DIAMETER	
Gauge No	Metric Equiv.	Metal Thickness	Steel, Stainless, Copper, Brass, Nickel Hole Dia.	Aluminium Hole Dia.
#2	2.2	0.46	1.63	
		0.61	1.70	1.63
		0.76	1.78	1.63
		1.22	1.85	1.70
		1.52	1.93	1.78
#4	2.9	0.46	2.18	
		0.61	2.26	
		0.76	2.39	
		1.22	2.44	2.18
		1.52	2.54	2.26
		2.67	2.59	2.39
#6	3.5	0.46	2.64	
		0.76	2.69	
		0.91	2.79	
		1.22	2.82	2.64
		1.52	2.95	2.69
		1.91	3.05	2.79
		2.67	3.25	2.82
		3.25		
#8	4.2	0.91	3.18	3.05
		1.22	3.25	3.25
		1.52	3.45	3.45
		1.91	3.56	3.56
		2.67	3.81	3.73
		3.43	3.86	3.78
		4.11		
		9.53		3.86
#10	4.8	0.76	3.66	
		0.91	3.73	
		1.52	3.86	3.66
		1.91	3.99	
		2.67	4.09	3.73
		3.43	4.32	3.91
		4.11	4.39	4.04
		5.08		
#12	5.5	0.91	4.22	
		1.22	4.32	4.09
		1.52	4.50	4.22
		1.91	4.62	4.39
		2.67	4.70	4.57
		3.43	4.98	4.63
		4.11	5.11	4.80
		5.08		
#14	6.3	1.22	4.93	
		1.52	5.05	5.05
		1.91	5.18	5.11
		2.67	5.31	5.18
		3.43	5.79	5.31
		4.93	5.94	5.61
		5.08		
		9.53		5.79

Common Thread Specifications

Metric

150 METRIC COARSE				150 METRIC
Nom. Dia.	Major Dia.	Dia. Inch	Thread Pitch	Thread Pitch
M1.6	1.60	0.0630	0.35	
M1.8	1.80	0.0709	0.35	
M2	2.00	0.0787	0.40	
M2.2	2.20	0.0866	0.45	
M2.5	2.50	0.0984	0.45	
M3	3.00	0.1181	0.50	
M3.5	3.50	0.1378	0.60	
M4	4.00	0.1575	0.70	
M4.5	4.50	0.1772	0.75	
M5	5.00	0.1969	0.80	
M6	6.00	0.2362	1.00	
M8	8.00	0.3150	1.25	1.00
M10	10.00	0.3937	1.50	1.25
M12	12.00	0.4724	1.75	1.50
M14	14.00	0.5512	2.00	1.50
M16	16.00	0.6299	2.00	1.50
M18	18.00	0.7087	2.50	1.50
M20	20.00	0.7874	2.50	1.50
M24	24.00	0.9449	3.00	2.00

Imperial

UNIFIED INCH PRODUCTS					B.S INCH PRODUCTS				
Nom. Dia.	Major Dia.		T.P.I		Nom. Dia.	Major Dia.		T.P.I	
	mm	Inch	UNC	UNF		mm	Inch	BSW	BSF
#0	1.52	0.060		80					
#1	1.85	0.073	64	72					
#2	2.18	0.086	56	64					
#3	2.51	0.099	48	56					
#4	2.84	0.112	40	48					
#5	3.18	0.125	40	44	1/8			40	
#6	3.51	0.138	32	40					
#8	4.17	0.164	32	36					
#10	4.83	0.190	24	32	3/16			24	32
#12	5.49	0.216	24	28					
(#14) 1/4	6.35	0.250	20	28	1/4			20	26
5/16	7.95	0.313	18	24	5/16			18	22
3/8	9.53	0.375	16	24	3/8			16	20
7/16	11.13	0.438	14	20	7/16			14	16
1/2	12.70	0.500	13	20	1/2			12	16
9/16	14.30	0.563	12	18	9/16			12	16
5/8	15.88	0.625	11	18	5/8			11	14
3/4	19.05	0.750	10	16	3/4			10	12
7/8	22.23	0.875	9	14	7/8			9	11
1	25.40	1.000	8	12	1			8	10

Every effort has been made to ensure that accuracy of information provided in this catalogue. Sentinel Group cannot warrant the information however, expressly or implied, and any liability arising from it is expressly excluded. Customers must satisfy themselves as to the suitability of products and the technical information relating to them, and it is recommended that you can conduct your own tests to establish suitability. This does not effect your statutory rights.

Fastener Material Selection

Due to the wide variety of material used in fastener manufacture the following should be considered to aid selection.

In previous times it was considered necessary for periodical repair of mechanical and electrical components. Today greater consideration is being given to the reduction of maintenance. In cases where a fastener must be removed, corrosion resistance is particularly important to avoid corrosion hindering or preventing fastener removal.

The cost of dealing with corroded fasteners is more expensive than using corrosion resistant fasteners originally. This is especially so when other costs resulting from fastener failure, such as lost production or down time, are taken into consideration.

A low cost option for designers considering corrosion resistance are plated fasteners. These are usually manufactured from mild steel and given a corrosion resistant coating of gal. or zinc. Whilst these coatings may be adequate in non severe corrosive conditions, many designers consider the additional cost of an inherently corrosion resistant material, such as stainless steel, to be an inexpensive insurance against possible failure or discolouration.

In considering the cost factor in using stainless steel fasteners, it is interesting to note that the overall cost of the finished product will generally be affected only by an insignificant amount if we choose stainless.

Where a different colour or surface finish is required for aesthetic appeal this requirement can usually be accommodated in stainless steel.

The designer should consider a fastener as an integral part of the design because a joint is normally under stress and possibly where a failure is likely to occur. Therefore designers should start with the best fastener and design the joint around it.

Stainless Steels

Stainless steel is a family of iron-base alloy steel containing 10.5% or more chromium, and other alloys such as nickel, manganese, molybdenum, sulphur, etc.

The chromium takes care of corrosion and heat resistance. Corrosion resistance is due to the presence of a naturally occurring chromium-rich oxide film on the steel's surface. This inert film adheres tightly to the metal and is rapidly self repairing in the presence of oxygen or surface damage.

The other alloys in stainless steel also enhance corrosion resistance and impart certain characteristics with respect to strength and fabricability.

Stainless steel as used in fastener manufacture is normally identified by the following three terms on the basis of their metallurgical structure. Under each classification the material tends to have similar characteristics with regards corrosion resistance, hardenability and fabricability.

Austenitic - These stainless steels are chromium-nickel and chromium-nickel-manganese compositions. They are

hardenable by cold working and are non-magnetic in the annealed condition. Typical of this group is Type 304 or A2 which contains at least 18% chromium and 8% nickel, hence its 18-8 name.

Ferritic - These stainless steels are straight chromium steels that are not hardenable by heat treatment and slightly hardenable by cold working. All this type is magnetic. Type 430 is a typical example.

Martensitic - These stainless steels are straight chromium that can be hardened by heat treatment only. All this type is magnetic and Type 410 is a typical example.

Stainless Steel - The Right Choice

To aid the designer to choose the correct grade of stainless steel in a particular application, the following should be considered.

- All the austenitic stainless steels have excellent corrosion resistance. Type 304 (A2) is the most widely used and is virtually immune to foodstuffs, sterilising solutions, most organic chemicals and many inorganic chemicals.
- If an application demands higher corrosion resistance, Type 316 (A4) is the next choice. This type resists corrosion in environments containing chlorides or sulphurous acid compounds. It can also be used in phosphoric and acetic acids that can cause corrosion to Type 304.
- The relative resistance to corrosion among the common stainless steel fastener materials is: Austenitic (316) superior, (304) excellent, Ferritic (430) good, Martensitic (410) fair.

When these types have been considered on the basis of their corrosion-resistant properties the next concern will be their tensile strength or its capacity to withstand load. See the following chart.

Stainless Steel Fasteners - Installation Procedures

For a fastener to be effective it will be obvious to the designer the fastener must be installed correctly. Incorrect installation can lead to difficulty such as seizing and galling or alternatively the fastener may work loose with vibration.

Reasonable care should be taken in handling fasteners to ensure threads are kept clean and free of dirt.

It is also critical that the fastener is installed to the correct torque. Trouble occurs in this area when fastener installation is attempted without correct torque measuring tools. There are some guidelines in this situation.

- 1) Tighten the fastener finger tight.
- 2) Tighten the fastener one additional turn (360 degrees).

Note: This specification may be too high for 410 type hardened stainless steel and primarily applies to Austenitic stainless steel fasteners.

Tensile Strength of Nine Fastener Alloys

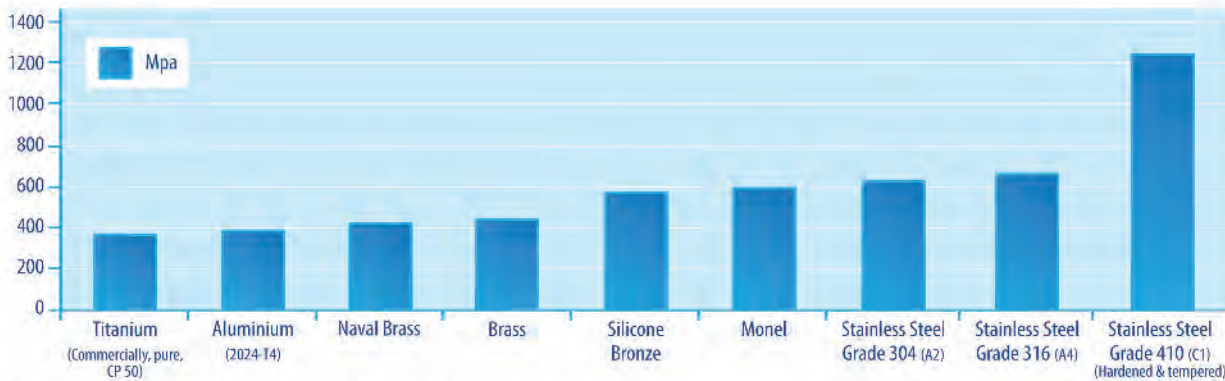

Corrosion - A Closer Look

The best way to combat the destructive character of corrosion is by prevention. One common practice in industry is to use a fastener material that is more corrosion resistant than the joining materials. The reason being, the fastener is the key to joint integrity and corrosion affected fasteners may cause a major failure, whereas the same amount of corrosive attack elsewhere may not cause a problem.

There are several types of corrosion that can occur in fasteners. The most prevalent form is called galvanic corrosion.

Galvanic corrosion can occur between dissimilar metals in the presence of an electrolyte which could be no more than polluted water. When the two metals are in contact, in effect, a battery is created. Current flows and one of the metals corrodes.

In considering galvanic corrosion it is important to know which of the two metals is more anodic (least noble). This metal will have corrosion accelerated. See following table.

Guidelines For Selection Of Fasteners Based On Galvanic Action

Fastener Metal / Base Metal	Zinc & Galvanised Steel	Aluminium & Aluminium Alloys	Steel & Cast Iron	Brasses, Copper, Bronzes, Monel	Martensitic Stainless Type 410	Austenitic Stainless Types 302/304, 303, 305
Zinc and Galvanised Steel	A	B	B	C	C	C
Aluminium and Aluminium Alloys	A	A	B	C	Not Recommended	B
Steel & Cast Iron	A,D	A	A	C	C	B
Temp (Lead-Tin) Plated Steel Sheets	A,D,E	A,E	A,E	C	C	B
Brasses, Copper, Bronzes, Monel	A,D,E	A,E	A,E	A	A	B
Ferritic Stainless Steel (Type 430)	A,D,E	A,E	A,E	A	A	A
Austenitic Stainless Steel (Type 302/304)	A,D,E	A,E	A,E	A,E	A	A

KEY

A. The corrosion of the base metal is not increased by the fastener.

B. The corrosion of the base metal is marginally increased by the fastener.

C. The corrosion of the base metal may be markedly

increased by the fastener material.

D. The plating on the fastener is rapidly consumed, leaving the bare fastener metal.

E. The corrosion of the fastener is increased by the base metal.

NOTE: Surface treatment and environment can change activity.

Every effort has been made to ensure that accuracy of information provided in this catalogue. Sentinel Group cannot warrant the information however, expressly or implied, and any liability arising from it is expressly excluded. Customers must satisfy themselves as to the suitability of products and the technical information relating to them, and it is recommended that you can conduct your own tests to establish suitability. This does not effect your statutory rights.

Date: _____

I/We hereby apply for a trading account and submit the following confidential information for this purpose:

Company name: _____ ACN: _____

Trading name: _____ ABN: _____

Date Commenced Trading: _____ No. of Employees: _____

Public Company () Private Company () Partnership () Sole Trader () Trust ()

Registered Office: _____ Post Code: _____

Postal Address: _____ Post Code: _____

Name of Buying Group (If applicable): _____

Business Premises: Leased / Rented () Mortgaged () Freehold ()

Delivery Address: _____

Telephone No.: _____ Facsimile No.: _____

Credit Required \$

Email: _____ Type of Business: _____

Directors / Proprietors:

Full Name	Private Address	Telephone No.
1. _____	_____	_____
2. _____	_____	_____
3. _____	_____	_____

Accounts Contact: _____ Phone: _____

Purchasing Contact: _____ Phone: _____

Bankers & Branch: _____

Chartered Accountant: _____

Trade References: (Minimum of 3 required)

Full Name	State	Telephone No.
1. _____	_____	_____
2. _____	_____	_____
3. _____	_____	_____
4. _____	_____	_____

Credit Terms

1. Full payment strictly by 30th day of month following invoice date.
2. An account keeping fee may be imposed on overdue accounts.
3. Accounts referred to a Collections Agency or Solicitor will have all legal costs and commission added to the amount due.
4. Orders are subject to Sentinel Group Pty Ltd published Terms and Conditions.
5. Property in any goods sold will not pass until payment for these goods is made in full.

Acceptance

Signed: _____ Name: _____ Date: _____
(Director / Proprietor) (Please Print Proprietor)

INDEX

2 HOLE	PAGE NO.
Countersunk Machine Screws.....	84 - 85
Pan Head Machine Screws.....	86 - 87
Countersunk Self Tappers.....	88 - 90
Pan Head Self Tappers.....	91 - 93
6 LOBE See Resytork	
APPLICATION ADVICE	42 - 143
ARMOUR RINGS	116 - 117
BARREL NUTS See Resytork & Stellar	
CLUTCH HEAD	
Countersunk Self Tappers.....	70
Countersunk Wood Screws.....	71 - 72
Round Head Self Tapping Screws.....	73 - 74
Round Head Machine Screws.....	75 - 76
Shoulder Screws and Barrel Nuts.....	77
CREDIT APPLICATION FORM	150
FASTDRIVE Concrete Anchors.....	127
FOUR HOLE Nut & Bolt System.....	132
GOODS RETURN FORM	149
GRUB SCREWS See Resytork	
KINMAR	
Removable Nuts.....	106 - 107
Permanent Nuts.....	108 - 109
Removable Bolts.....	110
Permanent Bolts.....	111
Removable Sleeve Anchors.....	130
Permanent Sleeve Anchors.....	131
MADE TO MEASURE	140 - 141
MERCHANDISER STAND	139
NO GO Security Enclosure.....	120
ONE WAY See Clutch Head	
OVAL Pan Head Machine Screws.....	100 - 101
PENTAFORCE	
Countersunk Machine Screws.....	38 - 39
Button Head Machine Screws.....	40 - 41
Countersunk Self Tappers.....	42 - 43
Button Head Self Tappers.....	44 - 45
Pan Head Type 17 Screws.....	46
Pan Head Self Drilling Screws.....	47 - 48
PIN HEX	
Countersunk Machine Screws.....	38 - 39
Button Head Machine Screws.....	40 - 41
Raised Countersunk Machine Screws.....	42 - 43
Countersunk Self Tapping Screws.....	44 - 45
Button Head Self Tapping Screws.....	46
POST HEADS See Barrel Nuts	
POST SOCKET See Pin Hex	
POST TORX See Resytork	
PROMOTIONAL ORDER FORM	144 - 145
PYRANUT	121

QUADTECH	PAGE NO.
Button Head Type 17 Screws.....	102
Button Head Self Drilling Screws.....	103
RESYTORK	
Countersunk Machine Screws.....	4 - 11
Button Head Machine Screws.....	12 - 20
Grub Screws.....	20
Countersunk Self Tapping Screws.....	22 - 24
Button Head Self Tapping Screws.....	25 - 27
Pan Head Self Drilling Screws.....	28 - 30
Countersunk Self Drilling Screws.....	31
Button Head Type 17 Screws.....	32
Countersunk Barrel Nuts.....	33 - 34
Button Head Barrel Nuts.....	35 - 37
Button Head Removable	
Sleeve Anchors.....	128
Countersunk Removable	
Sleeve Anchors.....	129
SCREWBOLTS	
Patented Button Head Concrete Screw.....	124
Patented Countersunk Concrete Screw.....	125 - 126
SCROLL Nuts.....	122 - 123
SENTINEL	
Countersunk Machine Screws.....	78
Pan Head Machine Screws.....	79 - 80
Threadforming Machine Screws.....	81
Countersunk Wood Screws.....	82 - 83
SHEAR	
Nuts.....	112 - 113
Bolts.....	114 - 115
SLAB TEE Nut, TRIDENT Nut.....	119
SLEEVE ANCHORS See Resytork & Kinmar	
SNAKE EYES See 2 Hole	
STELLAR Nuts.....	118
TECHNICAL INFORMATION	146 - 148
TOOLS	134 - 138
TORXPLUS	
Countersunk Self Tappers.....	94 - 95
Button Head Self Tappers.....	96 - 97
TORX SECURITY See Resytork	
TRIHEAD Security Screws.....	133
TRI-LOBULAR	
Button Head Type 17 Screws,	
Button Head Self Drillers.....	98
Machine Screws.....	99
UNI-SET Range.....	104 - 105