

The Adhesive and Sealant Specialists



Adheseal

Product Guide

Construction • Manufacturing • Marine • Automotive

www.adheseal.com.au

First Edition

Adheseal

The Adhesive and Sealant Specialists

ABOUT

Adheseal is a trade store specialising in sealants and adhesives. We also offer a full range of consumables including fasteners, fixings and safety products. We are a Queensland family owned and operated business for over 28 years and strive to demonstrate to our customers the advantages of working with us by providing personalised service, support, practical solutions and industry knowledge supported by proven commercial quality products at competitive prices. Our product range is extensive which we supply to industries such as construction, manufacturing, automotive and marine throughout Australia.

OUR FAMILY BUSINESS

Adheseal had its birth in October 1989. Mal Johnson was first introduced to the industry in 1974 when he became a sales representative for Davis Fuller Adhesives. Over the next 40 years Mal was involved with the start-up of two large multi-national companies which gave him the knowledge to get Adheseal established and become what it is today. His wife Veronika was also involved in the industry as she worked beside Mal to get these businesses established.

In September of 1989 Mal found himself without a job. With a bit of encouragement from the family he decided to start a family business which they called Adheseal. Today Adheseal has grown into three branches with the Head Office in Brisbane, a branch on the Sunshine Coast and a Fastening Division named Adhefast also in Brisbane.

Mal and Veronika are still running the business with the support of their son Stephen, daughter Anita and long term Adheseal team (family) which they are ever so grateful and proud of. Over the years Adheseal has developed some close relationships with many high profile international companies which has given it access to a range of hi-tech products that has enabled Adheseal to succeed in providing quality products. Mal and Veronika are proud of what we have achieved and look forward to the next chapter.

SERVICING QUEENSLAND

Adheseal Head Office

26 Wolverhampton Street
Stafford, Queensland 4053
Phone: (07) 3356 0000
sales@adheseal.com.au

Adheseal Sunshine Coast

2/18 Kessling Ave
Kunda Park, Queensland 4556
Phone: (07) 5477 0022
sc@adheseal.com.au

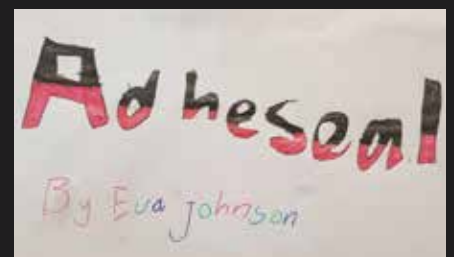

By Mal & Veronika's first Grandchild Eva

www.adheseal.com.au

Adhesives & Sealants

General Adhesives & Sealants	5
Polyurethanes	9
MS Polymers & Hybrids	17
Silicones	21
Fire Rated Sealants	27
Acrylics / Water Based Sealants	29
Flooring Adhesives	31
PVA Glues	35
Contact Adhesives	37
Megapoxy Epoxies / Grouts & Pigments	41

Primers

Water Based Primers	48
Solvent Based Primers	51
Epoxy Primers	53

Waterproofing Membranes

Water Based Liquid Applied Membranes	56
UV Exposed - Water Based Liquid Applied Membranes	60
Bituminous Liquid Applied Membranes	61
Solvent Based Liquid Applied Membranes	62
Cementitious Membranes	64
Torch Applied / Sheet Membranes	65

Concrete Repair & Treatment

FlexKrete Concrete Repair System	68
Bonding Agents	76
Efflorescence Remover	76
Plugging	76
Expansion & Cold Joint Expandable Waterstop	77
Epoxy Grouts & Repair & Injection Products	77
Cementitious Grouts & Repair Products	79
Polyurethane Crack Injection Products	80
Crack Injection Hardware	81

Flooring, Roofing & Decking

Floor Levelling Compounds	86
Liquid Flashing Repair Products	86
Protective & Decorative Coatings	86
Seamless Floor Coatings	88
Buzon Adjustable Pedestal System	92

Solvents, Thinners & Cleaning

Solvents & Thinners	102
Sealant & Adhesive Removers	104
Degreaser	104
Cleaning Wipes	104
Industrial Cleaning Rags	105

Construction Essentials

Tapes	108
Foam & Backing Rod	109
Angles & Trims	110
Hobs	114
Waterstop Streamline	117
Sand	118
Waterproofing Reinforcement & Protection Products	118
Floor Wastes / Grates & Channels	122

Tools, Accessories & Safety Equipment

Paint Brushes Rollers & Accessories	126
Application Guns	128
Application Gun Accessories	130
Caulking Accessories	132
Mixing Buckets & Measuring Cups	134
Floor & Wall Scrapers	134
Notch Trowels	136
Knives & Blades	136
Adhesive Mixers & Mixing Paddles	137
Concrete Grinding & Polishing Equipment	138
Spray Equipment	139
Safety & Protective Equipment	140

Adhesives & Sealants

General Construction Adhesives & Sealants

EUROFIX FAST

AN AMAZING NEW 10 SECOND BOND PROFESSIONAL ADHESIVE



High strength, commercial grade cyanoacrylate adhesive that bonds in 10 seconds.

Features

- 10 second bond
- Commercial grade adhesive
- High bonding strength
- Suitable for vertical and overhead applications
- Bonds porous and non-porous substrates
- Bonds difficult surfaces
- Gel adhesive

Applications

- For bonding most common surfaces where high strength and rapid bonding times are required
- Suitable for bonding metal, MDF, wood, chipboard, glass, rubber, many plastics, leather, fibreglass and many other common substrates
- Suitable for many commercial and industrial applications

Colour	Size	Code
Clear	50ml	EUROFAST/50
Clear	100ml	EUROFAST/100



Scan for more information

BONDS TO

WOOD • CONCRETE • METAL • RUBBER • MOST PLASTICS • LEATHER • PLUS MANY OTHER SUBSTRATES



10 SECOND BOND



COMMERCIAL GRADE



HIGH STRENGTH



BONDS POROUS AND NON-POROUS SURFACES



BONDS DIFFICULT SURFACES

Adheseal Multi-Tack Construction Adhesive

Newly formulated green star compliant solvent free Builders' Nails / Gap Filler / Joint Sealant.



Features

- 3 products in 1 - adhesive / joint sealant / gap filler
- Suitable for interior and exterior applications
- Paintable
- High initial grab
- Does not become brittle
- Flexible
- Water clean up
- Excellent UV resistance
- Low VOC (complies with Green Star VOC)

Applications

- General purpose construction adhesive
- General purpose gap filling and joint sealing
- Flooring and wall systems
- Bonding timber, metal concrete and most common construction materials
- Cornice adhesive
- Bonding timber to studs and joists
- Installation of wall sheeting, internal and external mouldings
- Bond polystyrene foam components

Available Colours*



Colour	Size	Code
Beige	300ml Cartridge	MULTITACK/CTG
Beige	600ml Sausage	MULTITACK/SSG



NEW PRODUCT



UV RESISTANT



GREEN STAR VOC



Adheseal Gap Filla

Flexible multipurpose acrylic gap filler.

Features

- Commercial grade
- Interior and exterior applications
- Paintable
- Water clean up
- Highly flexible
- Excellent UV resistance

Available Colours*



Colour	Size	Code
White	450gm Cartridge	GAPFILLA/CTG



Adheseal Builders Nails

General purpose construction adhesive suitable for a wide range of applications.

Features

- Good adhesion to most common construction materials
- Suitable for interior and exterior applications
- Fast tack time

Available Colours*



Colour	Size	Code
Beige	320gm Cartridge	BUILDNAIL/CTG



HV Duct

An acrylic sealant for sealing around the connecting flanges on high velocity ducting.

Features

- Fire rated (tested to AS1530.3)
- Flexible
- Water clean up
- Excellent UV resistance
- Low VOC (complies with Green Star VOC)

Available Colours*



Colour	Size	Code
Grey	450gm Cartridge	HVDUCT/CTG

*Colours are not exact. Colours shown are a representation only. Please refer to the actual product sample.

LOW VOC



Adheseal Unobond

COHESIVE STRENGTH ★★★★★ ELASTICITY ★☆☆☆☆

Unobond is a single component, quick setting, moisture cured polyurethane adhesive. Commonly used for structural applications. It has excellent water resistance and provides an extremely strong structural bond.

Features

- High bond strength
- Can be used on slightly damp surfaces
- Resistant to temperature extremes
- Resistant to moisture and chemicals
- Fast curing
- Adheres to most common building materials
- Water resistant
- D4-DIN EN204 (Unobond Cartridge only)
- Low VOC (complies with Green Star VOC)

Applications

- Fixing and gluing wooden elements to other various porous and non-porous elements
- Timber joinery, metal fabrication and boat production and more
- All bonding applications that need a high water resistance
- Wood, plasterboard, particleboard, aluminium, iron, steel, sheet metal, polystyrene foam, insulation foam, concrete, FC sheeting, brick, masonry, veneer, melamine, many plastics and many other common substrates.

Type	Colour	Size	Code
Gel (D4-DIN EN204)	Opaque	310ml Cartridge	UNOBOND/CTG
Liquid	Blue	6Kg Can	UNOFC/6

LOW VOC



Eurofix PU Marine

COHESIVE STRENGTH ★★★★★ ELASTICITY ★☆☆☆☆

A one-component, fast curing, moisture cured, liquid polyurethane adhesive. It possesses high water resistance and structural bonding strength.

Features

- Easy application, low viscosity
- High bond strength
- Water resistant (D4-DIN EN204)
- Can be used on slightly damp surfaces
- Resistant to temperature extremes
- Resistant to moisture and chemicals
- Fast Curing (370 PU Marine Express only)
- Low VOC (complies with Green Star VOC)

Applications

- Fixing and gluing wooden elements to other various porous and non-porous elements as wood, metal, concrete, polystyrene foam
- Timber joinery, metal fabrication and boat production and more
- All bonding applications that need a high water resistance

Type	Colour	Size	Code
360 PU Marine	Opaque	560g Bottle	EUROPUMAR/560
370 PU Marine Express (Fast Cure)	Opaque	560g Bottle	EUROPUEXP/560



Polyurethane NBS Foam

A single component polyurethane expanding foam. It expands up to 40 times its size when exposed to air. Suitable for sealing and insulating around window and door frames as well as an adhesive for polystyrene architectural mouldings.

Features

- Excellent adhesion on most construction
- No primer required
- Expands up to 40 times its size
- Paintable
- Applied with specialised applicator gun for greater control

Applications

- Sealing and insulating around window and door frames
- Adhesive for polystyrene architectural mouldings
- Adhesive, Insulator
- Void Filler

Colour	Size	Code
Cream	750ml Can	FOAMPUGG/750



Hot Melt Glue Sticks

A translucent, general-purpose hot melt in a stick used to will bond to a wide variety of materials including cardboard, most plastics metals, timbers, fabrics and ceramics and more. A Hot Melt Glue Gun (K-1000) is required for application.

Colour	Size	Code
Opaque	1kg Bag	GLUESTICKAE110

Adhesives & Sealants

Polyurethanes

Coverage Calculation Guide

Step 1 - Calculate litres required

Joint Width (cm) x Joint depth (cm) x Joint length (cm) ÷ 1000 = Litres required

Step 2 - Calculate product quantity required

Cartridges: Litres required ÷ 0.3 = quantity of cartridges required

Sausages: Litres required ÷ 0.6 = quantity of sausages required

Please note: Allow for approximately 15% wastage

Rating System

The star rating system used in this catalogue is a guide only. Refer to the TDS when selecting suitable products. A product with a cohesive strength rating of 3 stars or more is considered a structural grade adhesive.



Available Colours*



Adheseal PU-240

COHESIVE STRENGTH ★★★★★ ELASTICITY ★★★★★

Single component, moisture curing, polyurethane adhesive / sealant. This tough and durable adhesive / sealant can be used in a wide range of applications such as joint sealing or structural bonding. Suitable for construction, industrial, marine and automotive industries.

Features

- Low modulus
- Excellent bond to most construction materials
- Very tough and durable
- Paintable
- Good weathering properties
- Low VOC (complies with Green Star VOC)

Applications

- High performance
- Structural bonding
- Fast curing waterproofing sealant
- General joint sealing
- Boat deck sealant
- Construction, marine and automotive

Colour	Size	Code
White	310ml Cartridge	PU240WH/CTG
Grey	310ml Cartridge	PU240GR/CTG
Black	310ml Cartridge	PU240BL/CTG



Available Colours*



Adheseal PU-50FC

COHESIVE STRENGTH ★★★★★ ELASTICITY ★★★★★

PU-50FC is a fast curing, extremely tough and durable polyurethane adhesive / sealant. With a high shore A hardness this is a high performance product suitable for many applications from a high structural strength adhesive to a non-pick joint sealant and more. Suitable for construction, industrial, marine and automotive industries.

Features

- Fast curing
- Medium modulus
- High performance
- Paintable
- Easily sandable
- Extremely tough and durable
- Good weathering properties
- Excellent bond to most construction materials
- Low VOC (complies with Green Star VOC)

Applications

- Structural bonding
- Joint sealing
- Non-pick sealant suitable for prisons, schools and public access areas
- Marine manufacturing
- Boat deck sealant
- Automotive body building

Colour	Size	Code
White	600ml Sausage	PU50WH/SSG
Grey	600ml Sausage	PU50GR/SSG



Available Colours*



Adheseal PU-25FC

COHESIVE STRENGTH ★★★★★ ELASTICITY ★★★★★

Adheseal PU-25FC is a fast curing, single component, moisture curing, polyurethane adhesive / sealant. This tough and durable adhesive / sealant can be used in a wide range of applications such as joint sealing or structural bonding. Suitable for construction, industrial, marine and automotive industries.

Features

- Fast curing
- High performance
- Low modulus
- Excellent bond to most construction materials
- Very tough and durable
- Paintable
- Potable water certificate AS/NZS4020:2005
- Good weathering properties
- Low VOC (complies with Green Star VOC)

Applications

- General bonding
- Tilt up and precast joints in buildings and civil structures (fast curing)
- Trafficable expansion joints
- Construction joints (fast curing)
- Fast curing waterproofing sealant
- Sealing water retaining structures
- General joint sealing (fast curing)

Colour	Size	Code
White	600ml Sausage	PU25WH/SSG
Grey	600ml Sausage	PU25GR/SSG
Off-Grey	600ml Sausage	PU25OFGR/SSG
Black	600ml Sausage	PU25BL/SSG

*Colours are not exact. Colours shown are a representation only. Please refer to the actual product sample.



Available Colours*



Adheseal PU-15

COHESIVE STRENGTH ★★★★★ ELASTICITY ★★★★★

Adheseal PU-15 is a high performance, single component, moisture curing, polyurethane joint sealant. Tough and durable, it is suitable for applications such as facade joints, window frame installations, tilt up and precast joints and will bond to most common construction materials. Suitable for construction, industrial, marine and automotive industries.

Features

- Very Low modulus
- Excellent bond to most common construction materials
- Very durable
- Paintable
- Good weathering resistance
- Non-sag in vertical joints
- Long skin time
- Low VOC (complies with Green Star VOC)

Applications

- Tilt up and precast joints in buildings and civil structures
- Construction joints
- External walling and cladding joints
- Curtain walling
- Window frame installation
- Sealing penetrations in walls or floors such as ducts and piping
- Retaining walls
- General purpose sealant in construction

Colour	Size	Code
White	600ml Sausage	PU15WH/SSG
Concrete Grey	600ml Sausage	PU15CGR/SSG
Black	600ml Sausage	PU15BL/SSG



Available Colours*



PU25 SOL

COHESIVE STRENGTH ★★★★★ ELASTICITY ★★★★★

Self-levelling, fast curing, single component, moisture curing, polyurethane adhesive / sealant. This tough and durable adhesive / sealant can be used in applications where a low viscosity product is required..

Features

- Self-levelling
- Low modulus
- Very long skin time
- Excellent bond to most common construction materials
- Very tough and durable
- Paintable
- Non-bubbling
- Good weathering properties
- Low VOC (complies with Green Star VOC)

Colour	Size	Code
Grey	600ml Sausage	PU25GRSOL/SSG



Available Colours*



Megaprene 40

COHESIVE STRENGTH ★★★★★ ELASTICITY ★★★★★

Single component gun grade moisture curing polyurethane construction joint sealant.

Features

- Trafficable
- Tough and durable commercial grade joint sealant
- Good resistance to fuel
- Good weathering properties
- Good chemical resistance
- Main Roads approved product
- Low VOC (complies with Green Star VOC)

Colour	Size	Code
Grey	600ml Sausage	MEGA40GR/SSG

*Colours are not exact. Colours shown are a representation only. Please refer to the actual product sample.



Available Colours*



PU Construction

COHESIVE STRENGTH ★★★★★ ELASTICITY ★★★★★

One part, moisture curing, elastic joint polyurethane sealant. It is commonly used as a general purpose sealant for sealing joints in building construction.

Features

- Low VOC (complies with Green Star VOC)

Colour	Size	Code
Grey	600ml Sausage	PUCONGR/SSG



Available Colours*



Bostik Seal n Flex 1

Low modulus, one component moisture curing polyurethane sealant. It is durable with a long skin time. Seal n Flex 1 bonds to most common construction materials.

Colour	Size	Code
White	600ml Sausage	SNFWH/SSG
White	300ml Cartridge	SNFWH/CTG
Grey	600ml Sausage	SNFGR/SSG
Grey	300ml Cartridge	SNFGR/CTG
Black	600ml Sausage	SNFBL/SSG
Black	300ml Cartridge	SNFBL/CTG
Off White	600ml Sausage	SNFOW/SSG
Classic Bone	600ml Sausage	SNFCB/SSG
Manilla Sand	600ml Sausage	SNFMAN/SSG
Bahama Beige	600ml Sausage	SNFBB/SSG
Limestone	600ml Sausage	SNFLI/SSG
Sandstone	600ml Sausage	SNFSST/SSG
Epping Grey	600ml Sausage	SNFEPGR/SSG
Redwood	600ml Sausage	SNFRW/SSG
Bronze	600ml Sausage	SNFBR/SSG



Available Colours*



Bostik Seal n Flex FC

One part, fast curing, elastic joint sealant polyurethane sealant suitable for a wide range of building and construction purposes. It can be used in indoor and outdoor applications and for various jobs which require a flexible adhesive or a durable joint sealant.

Colour	Size	Code
White	600ml Sausage	SNFFCWH/SSG
White	300ml Cartridge	SNFFCWH/CTG
Grey	600ml Sausage	SNFFCGR/SSG
Grey	300ml Cartridge	SNFFCGR/CTG
Black	600ml Sausage	SNFFCBL/SSG
Black	300ml Cartridge	SNFFCBL/CTG

*Colours are not exact. Colours shown are a representation only. Please refer to the actual product sample.

Adheseal

Polyurethane Range

Automotive / Construction / Industrial / Marine

High Performance Commercial Grade



Tough & durable



Excellent weathering resistance



Australian owned



Internal & external applications



Paintable



Low VOC



Good UV resistance

Adheseal PU-15 Joint Sealant



Features:

- Long skinning time
- Short cut off string
- Outstanding movement capabilities

Uses:

- Expansion joints
- Construction joints
- External wall & cladding joints
- General purpose sealant

COHESIVE STRENGTH



ELASTICITY



Adheseal PU-25FC Adhesive / Sealant



Features:

- Fast curing sealant
- High strength adhesive
- High abrasion resistance
- High tear strength
- Sandable
- Potable water certificate

Uses:

- Waterproofing applications
- Industrial general purpose adhesive
- General joint sealing
- Trafficable joint sealant

COHESIVE STRENGTH



ELASTICITY



Adheseal PU-50FC Structural Adhesive / Sealant



Features:

- Fast curing
- High abrasion resistance
- High tear strength
- Structural strength adhesive
- Tough joint sealant
- Sandable

Uses:

- Permanent structural applications
- Non-pick joint sealant
- Trafficable joint sealant
- Automotive/marine structural adhesive

COHESIVE STRENGTH



ELASTICITY



Adheseal
The Adhesive and Sealant Specialists

Adheseal Head Office
26 Wolverhampton Street
Stafford, Queensland 4053
Phone: (07) 3356 0000
sales@adheseal.com.au

Adheseal Sunshine Coast
2/18 Kessling Ave
Kunda Park, Queensland 4556
Phone: (07) 5477 0022
sc@adheseal.com.au

www.adheseal.com.au



Available Colours*



Sikaflex Construction (AP)

One part, moisture curing, polyurethane joint sealant. It is commonly used as a general purpose sealant for sealing joints in building construction.

Colour	Size	Code
Grey	600ml Sausage	SIKACONGR/SSG



Available Colours*



Sika Pro

One part, moisture curing, elastic joint polyurethane sealant. It is commonly used for expansion / construction joints and general sealing joints in building construction.

Colour	Size	Code
White	600ml Sausage	SIKAPROWH/SSG
White	310ml Cartridge	SIKAPROWH/CTG
Off White	600ml Sausage	SIKAPROFFWH/SSG
Off White	310ml Cartridge	SIKAPROFFWH/CTG
Sandstone	600ml Sausage	SIKAPROSAN/SSG
Sandstone	310ml Cartridge	SIKAPROSAN/CTG
Pale Brown	600ml Sausage	SIKAPROPALEBR/SSG
Pale Brown	310ml Cartridge	SIKAPROPALEBR/CTG
Beige (Japan)	600ml Sausage	SIKAPROJBE/SSG
Beige (Japan)	310ml Cartridge	SIKAPROJBE/CTG
Grey	600ml Sausage	SIKAPROGR/SSG
Grey	310ml Cartridge	SIKAPROGR/CTG
Dark Grey	600ml Sausage	SIKAPRODKGR/SSG
Dark Grey	310ml Cartridge	SIKAPRODKGR/CTG
Dark Amber	600ml Sausage	SIKAPRODKAM/SSG
Dark Amber	310ml Cartridge	SIKAPRODKAM/CTG
Red Brick	600ml Sausage	SIKAPROBRIC/SSG
Red Brick	310ml Cartridge	SIKAPROBRIC/CTG
Redwood	600ml Sausage	SIKAPRORED/SSG
Redwood	310ml Cartridge	SIKAPRORED/CTG
Black	600ml Sausage	SIKAPROBL/SSG
Black	310ml Cartridge	SIKAPROBL/CTG

*Colours are not exact. Colours shown are a representation only. Please refer to the actual product sample.



Sika 11-FC

One part, moisture curing, elastic joint sealant and multipurpose adhesive based on polyurethane. It is suitable for indoor and outdoor use and various applications which require a flexible adhesive or a durable joint sealant.

Colour	Size	Code
White	600ml Sausage	SIKA11FCWH/SSG
White	310ml Cartridge	SIKA11FCWH/CTG
Grey	600ml Sausage	SIKA11FCGR/SSG
Grey	310ml Cartridge	SIKA11FCGR/CTG
Black	600ml Sausage	SIKA11FCBL/SSG
Black	310ml Cartridge	SIKA11FCBL/CTG
Japan Beige	600ml Sausage	SIKA11FCBE/SSG

Available Colours*



Sika Tank

One part, moisture curing, elastic polyurethane joint sealant which is used in areas for the storage, filling and handling of water polluting liquids.

Features

- Potable Water Approved
- Chemical Resistant

Colour	Size	Code
Grey	600ml Sausage	SIKATANKGR/SSG

Available Colours*



Adheseal

Cordless Caulking Gun

Lithium Ion Power / The Choice Of Professionals

*Colours are not exact. Colours shown are a representation only. Please refer to the actual product sample.

Adheseal

Hybrid MS Polymer Range

Automotive / Construction / Industrial / Marine



Low
VOC



Solvent
Free



Isocyanate
Free



Easy tooling & finishing



Excellent colour stability



Excellent primer-less adhesion



Internal & external applications



Paintable



Non-bubbling



Excellent UV resistance

Hi Flex Construction Joint Sealant



Features:

- Low VOC
- Outstanding UV resistance
- Low modulus
- Easy tooling - creamy texture
- Paintable (instantly with most paints)
- Matt finish
- Excellent primer-less adhesion

Uses:

- Expansion joints
- Construction joints
- External wall & cladding joints
- General purpose sealant

COHESIVE STRENGTH ★★★★★
ELASTICITY ★★★★★

Hi Flex 60LS Structural Adhesive / Sealant



Features:

- Low VOC
- Outstanding UV resistance
- Excellent colour stability
- Low modulus
- Easy tooling - creamy texture
- Paintable (instantly with most paints)
- Excellent primer-less adhesion

Uses:

- Permanent structural applications
- Non-pick joint sealant
- Trafficable joint sealant
- Automotive/marine structural adhesive

COHESIVE STRENGTH ★★★★★
ELASTICITY ★★★★★

Hi Power Extreme Structural Adhesive



Features:

- Low VOC
- Outstanding UV resistance
- Very high flexible bond strength
- High immediate grab strength
- Tough and durable
- Paintable (instantly with most paints)
- Excellent primer-less adhesion

Uses:

- Permanent structural applications
- Extreme vibration applications
- Extreme deformation applications
- Automotive/marine structural adhesive

COHESIVE STRENGTH ★★★★★
ELASTICITY ★★★★★

Adheseal
The Adhesive and Sealant Specialists

Adheseal Head Office
26 Wolverhampton Street
Stafford, Queensland 4053
Phone: (07) 3356 0000
sales@adheseal.com.au

Adheseal Sunshine Coast
2/18 Kessling Ave
Kunda Park, Queensland 4556
Phone: (07) 5477 0022
sc@adheseal.com.au

www.adheseal.com.au

Adhesives & Sealants

MS Polymers & Hybrids

Coverage Calculation Guide

Step 1 - Calculate litres required

Joint Width (cm) x Joint depth (cm) x Joint length (cm) ÷ 1000 = Litres required

Step 2 - Calculate product quantity required

Cartridges: Litres required ÷ 0.3 = quantity of cartridges required

Sausages: Litres required ÷ 0.6 = quantity of sausages required

Please note: Allow for approximately 15% wastage

Rating System

The star rating system used in this catalogue is a guide only. Refer to the TDS when selecting suitable products. A product with a cohesive strength rating of 3 stars or more is considered a structural grade adhesive.



Available Colours*



Hi Flex MS Construction

COHESIVE STRENGTH ★★★★★ ELASTICITY ★★★★★

Hi Flex Construction is a high performance MS polymer based hybrid sealant. It cures to form a tough, elastic seal with outstanding UV and weather resistance. It is green star compliant (low VOC) and is suitable for many construction, industrial, marine and automotive applications.

Features

- One component
- Low modulus
- Easy tooling - creamy texture
- Paintable (instantly with most paints)
- Outstanding UV resistance and colour stability
- Low VOC - Green star project compliant
- Non-hazardous - Isocyanate free
- Does not sag or slump in joints up to 30mm
- Excellent primer-free adhesive properties on most substrates

Applications

- Bonding and sealing
- Tilt up and precast joints in buildings and civil structures
- Trafficable expansion joints
- Construction joints
- External walling and cladding joints
- Curtain walling
- Window frame installation
- Sealing penetrations in walls and floors such as ducts and piping
- Retaining walls (above and below grade)

Colour	Size	Code
White	600ml Sausage	HIFLEXCONWH/SSG
Grey	600ml Sausage	HIFLEXCONGR/SSG
Black	600ml Sausage	HIFLEXCONBL/SSG



Available Colours*



Adheseal Hi Flex 40

COHESIVE STRENGTH ★★★★★ ELASTICITY ★★★★★

Hi Flex 40 is a high performance MS polymer based hybrid sealant/adhesive. This tough and durable adhesive / sealant can be used in a wide range of applications such as joint sealing or structural bonding with outstanding UV and weather resistance. It is green star compliant (low VOC) and is suitable for many construction, industrial, marine and automotive applications.

Features

- One component
- Low modulus
- Easy tooling - creamy texture
- Tough and durable
- Paintable (instantly with most paints)
- Outstanding UV resistance and colour stability
- Low VOC (complies with Green Star VOC)
- Non-hazardous - Isocyanate free
- Excellent primer-free adhesive properties on most substrates

Applications

- Tilt up and precast joints in buildings and civil structures
- Trafficable expansion joints
- Construction joints
- External walling and cladding joints
- Curtain walling
- Window frame installation
- Sealing penetrations in walls or floors such as ducts and piping
- Retaining walls (above and below grade)
- Sealing joints in water retaining structures
- Marine manufacturing
- Boat deck sealant
- Automotive body building

Colour	Size	Code
White	290ml Cartridge	HIFLEX40WH/CTG
Grey	290ml Cartridge	HIFLEX40GR/CTG
Black	290ml Cartridge	HIFLEX40BL/CTG

*Colours are not exact. Colours shown are a representation only. Please refer to the actual product sample.



Adheseal Hi Flex 60LS

COHESIVE STRENGTH ★★★★★ ELASTICITY ★★★★★

Hi Flex 60LS is an extremely tough and durable MS Polymer based adhesive / sealant. With a high shore A hardness this is a high performance product suitable for many uses from high structural strength adhesive applications to joint sealing.



Available Colours*



Features

- One component
- Structural Strength Adhesive
- Trafficable
- Paintable (instantly with most paints)
- Outstanding UV resistance and colour stability
- Pick Resistant
- Low VOC (complies with Green Star VOC)
- Non-hazardous - Isocyanate free
- Excellent primer-free adhesive properties on most substrates

Applications

- Structural bonding
- Joint sealing
- Non-pick sealant suitable for prisons, schools and public access areas
- Marine manufacturing
- Boat deck sealant
- Automotive body building

Colour	Size	Code
White	600ml Sausage	HIFLEX60LSWH/SSG
Grey	600ml Sausage	HIFLEX60LSGR/SSG
Black	600ml Sausage	HIFLEX60LSBL/SSG



Adheseal Hi Power

COHESIVE STRENGTH ★★★★★ ELASTICITY ★★★★★

Adheseal Hi-Power is a hybrid adhesive with outstanding initial grab strength. It is a powerful structural strength adhesive that can be used for bonding materials exposed to extreme applications such as vibrations or deformation in building and industrial applications. Adheseal Hi-Power has excellent adhesion to most common building materials.



Available Colours*



Features

- High performance adhesive
- Very high flexible bond strength
- Exceptional green strength
- Excellent shear strength
- Does not contain isocyanates, silicone or solvent
- Tough and durable
- Easy to tool and finish
- Excellent colour stability and UV resistance
- Paintable (instantly with most paints)
- Exceptional weather resistance
- Low VOC (complies with Green Star VOC)

Applications

- Applications exposed to excessive vibration or deformation
- Structural bonding
- Applications when a flexible structural bond is required
- Construction and industrial
- Marine manufacturing
- Automotive body building

Colour	Size	Code
White	290ml Cartridge	HIPWRWH/CTG
White	600ml Sausage	HIPWRWH/SSG

*Colours are not exact. Colours shown are a representation only. Please refer to the actual product sample.

Adheseal

S-100 Sanitary & Tile Silicone

Bathrooms / Kitchens / Glazing

High Performance Sanitary Grade



Mould resistant



Excellent weathering resistance



Low VOC



UV stable



Internal & external applications



Highly flexible

S-100 Sanitary Silicone is a high performance sanitary grade neutral cure silicone sealant. It is suitable for many applications including sealing bathrooms and kitchens and also glazing.

Features

- Resistant to mould and mildew growth
- Forms a durable, flexible waterproof seal
- Suitable for internal and external applications
- UV stable
- Excellent weather resistance
- It has excellent adhesion to most common building and engineering materials such as glass, aluminium, steel, ABS, stainless, tiles, marble and granite etc.
- Low VOC (complies with Green Star VOC)

Available Colours*



Clear



Stark White



Off White



Ivory



Travertine



Tile Grey



Eva Grey



Ashville Grey



Koala Grey



Dark Grey

Adheseal
The Adhesive and Sealant Specialists

Adheseal Head Office
26 Wolverhampton Street
Stafford, Queensland 4053
Phone: (07) 3356 0000
sales@adheseal.com.au

Adheseal Sunshine Coast
2/18 Kessling Ave
Kunda Park, Queensland 4556
Phone: (07) 5477 0022
sc@adheseal.com.au

*Colours shown are a representation only. Please refer to the actual product sample for exact colours.

www.adheseal.com.au

Adhesives & Sealants

Silicones

Coverage Calculation Guide

Step 1 - Calculate litres required

Joint Width (cm) x Joint depth (cm) x Joint length (cm) ÷ 1000 = Litres required

Step 2 - Calculate product quantity required

Cartridges: Litres required ÷ 0.3 = quantity of cartridges required

Sausages: Litres required ÷ 0.6 = quantity of sausages required

Please note: Allow for approximately 15% wastage



Available Colours*



Adheseal Roof & Gutter Silicone

Neutral cure, general purpose silicone sealant with fungicides, to reduce the growth of mould and mildew.

Features

- Excellent weathering resistance and durability
- UV stable
- Provides excellent bonding, without primer, to most materials used in the building and engineering industries such as glass, aluminium, steel, ABS, stainless steel, anodised products, concrete and wood
- Low VOC (complies with Green Star VOC)

Applications

- Bonding and sealing
- Weatherproofing
- General purpose applications

Colour	Size	Code
Translucent	300ml Cartridge	SILADRGTR/CTG
White	300ml Cartridge	SILADRGWH/CTG
Light Grey	300ml Cartridge	SILADRGLG/CTG
Black	300ml Cartridge	SILADRGBL/CTG



Available Colours*

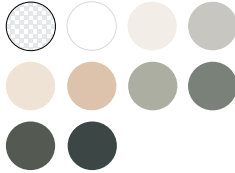

Adheseal S-100 Kitchen & Bathroom Silicone

A high performance sanitary grade neutral cure silicone sealant. It is suitable for many applications including sealing bathrooms and kitchens and also glazing.

Features

- Resistant to mould and mildew growth
- Forms a durable, flexible waterproof seal
- Suitable for internal and external applications
- UV stable
- Excellent weather resistance
- It has excellent adhesion to most common building and engineering materials such as glass, aluminium, steel, ABS, stainless, tiles, marble and granite etc.
- Low VOC (complies with Green Star VOC)

Colour	Size	Code
Clear	300ml Cartridge	SILADS100CL/CTG
Stark White	300ml Cartridge	SILADS100WH/CTG
Off White	300ml Cartridge	SILADS100OW/CTG
Ivory	300ml Cartridge	SILADS100IV/CTG
Travertine	300ml Cartridge	SILADS100TV/CTG
Tile Grey	300ml Cartridge	SILADS100TG/CTG
Eva Grey	300ml Cartridge	SILADS100EG/CTG
Ashville Grey	300ml Cartridge	SILADS100AG/CTG
Koala Grey	300ml Cartridge	SILADS100KG/CTG
Dark Grey	300ml Cartridge	SILADS100DG/CTG



Available Colours*



Adheseal N80 Silicone

A versatile architectural grade, neutral curing silicone sealant/adhesive.

Features

- High performance, architectural grade sealant
- Excellent weathering resistance and durability
- UV stable
- Provides excellent bonding, without primer, to most materials used in the building and engineering industries such as glass, aluminium, steel, ABS, stainless steel, anodised products, concrete and wood
- Low VOC (complies with Green Star VOC)

Applications

- Glazing butt joints
- Mirrors
- Bonding and Sealing
- Weatherproofing
- Construction architectural marine and manufacturing applications

Colour	Size	Code
Translucent	300ml Cartridge	SILADN80TR/CTG
Grey	300ml Cartridge	SILADN80GR/CTG
Black	300ml Cartridge	SILADRGBL/CTG

*Colours are not exact. Colours shown are a representation only. Please refer to the actual product sample.



Available Colours*



Adheseal Facade 3200

Adheseal Facade 3200 is a neutral cure, versatile, architectural grade hybrid silicone sealant that exhibits outstanding physical properties for projects and general building construction. It has excellent weathering resistance, durability, sealing and primer-less adhesive properties to most common substrates. Once cured, Facade 3200 bonds firmly to many substrates and gives a high performance seal for curtain walls, composite facades, weatherproofing and non-structural applications.

Features

- High performance, architectural grade sealant
- Excellent weathering resistance and durability
- No primer required (in most applications)
- Excellent UV Resistance
- Low VOC (complies with Green Star VOC)

Applications

- Window and door perimeter joints
- Weatherproofing, movement joints; facade panels, composite panel joints, metal cladding, glazing and caulking
- Non-structural curtain walls and building construction applications
- Sign installation

Colour	Size	Code
White	590ml Sausage	FACADEWH/SSG
Matt Grey	590ml Sausage	FACADEMGR/SSG
Matt Black	590ml Sausage	FACADEMBL/SSG



Available Colours*



Sealants Australasia N-10 Silicone

Designed for general purpose glazing and sealing applications where long term reliability is required. Weathering and UV resistance is excellent.

Features

- Outstanding UV and Weather Resistance
- Excellent Adhesion
- Excellent UV Resistance

Colour	Size	Code
Off White	300ml Cartridge	SILSN10OW/CTG
Sandstone	300ml Cartridge	SILSN10SST/CTG
Aluminium Grey	300ml Cartridge	SILSN10AL/CTG
Dark Grey	300ml Cartridge	SILSN10DG/CTG
Brown	300ml Cartridge	SILSN10BRN/CTG



Available Colours*



Sealants Australasia Sanitary Silicone

SA Sanitary Silicone Sealant is a one part, 100% oxime, neutral curing adhesive / sealant containing anti-fungicide to prevent mould growth. It resists mildew when exposed to prolonged hot and humid environments and is suitable for sealing in kitchens, vanities, bathrooms, shower screens and any other wet area applications.

Features

- Outstanding UV and Weather Resistance
- Excellent Adhesion
- Excellent UV Resistance

Colour	Size	Code
Translucent	300ml Cartridge	SILSANTRN/CTG
White	300ml Cartridge	SILSANWH/CTG
Ivory	300ml Cartridge	SILSANIV/CTG
Stone Beige	300ml Cartridge	SILSANSB/CTG
Tile Grey	300ml Cartridge	SILSANTG/CTG
Light Grey	300ml Cartridge	SILSANLG/CTG
Mid Grey	300ml Cartridge	SILSANMG/CTG

*Colours are not exact. Colours shown are a representation only. Please refer to the actual product sample.

N-60 Silicone - Sealants Australasia

An architectural grade, high bodied, non-slump silicone which has high green strength and an extra fast cure. Designed for applications such as butt joints, colonial bars, commercial glazing and roof mounted solar panels.



Available Colours*



Features

- Fast Cure
- High Strength
- Architectural Grade
- Excellent Adhesion
- Outstanding Weatherability

Colour	Size	Code
Translucent	300ml Cartridge	SILSN60TRN/CTG
White	300ml Cartridge	SILSN60WH/CTG
Grey	300ml Cartridge	SILSN60GR/CTG
Aluminium	300ml Cartridge	SILSN60AL/CTG
Black	300ml Cartridge	SILSN60BK/CTG



Available Colours*

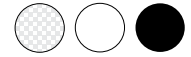

Sealants Australasia Silicone N

Premium architectural grade, neutral cure silicone sealant/adhesive. It is fast curing, highly elastic and has excellent performance with glazing and construction applications.

Colour	Size	Code
Translucent	300ml Cartridge	SILNTR/CTG
White	300ml Cartridge	SILNWH/CTG
Black	300ml Cartridge	SILNBL/CTG

Sealants Australasia Sealproof

Sealproof Silicone is a premium structural grade, neutral cure silicone sealant/adhesive. It has a high strength and is suitable for a wide variety of applications including structural glazing and butt joints. Sealproof was specially designed for use with many plastics including acrylic and polycarbonate (Lexan) - commonly used as a marine windscreen.



Available Colours*



Colour	Size	Code
White	300ml Cartridge	SILPRUWH/CTG
Grey	300ml Cartridge	SILPRUGR/CTG
Black	300ml Cartridge	SILPRUBL/CTG

Sealants Australasia Contractors

One part 100% acetic curing adhesive / sealant. It is an easy to use silicone designed for general purpose glazing and sealing applications where long term reliability is required. Weathering and UV resistance is excellent.



Available Colours*

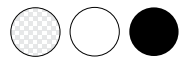

Features

- Fast Curing
- Outstanding UV and Weather Resistance
- Excellent Adhesion
- Excellent UV Resistance

Colour	Size	Code
Translucent	300ml Cartridge	SILCONTTR/CTG
White	300ml Cartridge	SILCONTWH/CTG
Black	300ml Cartridge	SILCONTBL/CTG

*Colours are not exact. Colours shown are a representation only. Please refer to the actual product sample.

Pasco 911 Glazing Silicone

Pasco Hypersil 911 is a high performance neutral cure silicone sealant which cures to form a tough and flexible waterproof seal. Suitable for a wide range of glazing, weatherproofing and specialist trade applications.



Available Colours*



Colour	Size	Code
Sandstone	300ml Cartridge	SILP911SST
Beige	300ml Cartridge	SILP911BEIGE
Chocolate	300ml Cartridge	SILP911CHOC
Stone Grey	300ml Cartridge	SILP911STGR
Volcano	300ml Cartridge	SILP911VOL

Pasco 912 Silicone

Pasco Hypersil 912 is a high performance neutral cure sanitary grade silicone sealant which cures to form a tough and flexible waterproof seal with the added advantage of resisting the growth of mould and mildew.



Available Colours*



Colour	Size	Code
White	300ml Cartridge	SILP912WHITE
Off White	300ml Cartridge	SILP912OFFWH
Magnolia	300ml Cartridge	SILP912MAGNO
Light Ivory	300ml Cartridge	SILP912LTIVORY
Almond Ivory	300ml Cartridge	SILP912ALMOND
Travertine	300ml Cartridge	SILP912TRAV
Caramel	300ml Cartridge	SILP912CARMEL
Teak	300ml Cartridge	SILP912TEAK
Mushroom	300ml Cartridge	SILP912MUSH
Beige Grey	300ml Cartridge	SILP912BEIGEGR
Tile Grey	300ml Cartridge	SILP912TGR
Light Grey	300ml Cartridge	SILP912LTGREY
Pewter	300ml Cartridge	SILP912PEWTER
Bluestone	300ml Cartridge	SILP912BLUST
Slate Grey	300ml Cartridge	SILP912SLATE

Bostik 6S Silicone

6S is a one component, neutral cure, silicone sealant with a mould inhibitor.

Features

- Sealing showers, bathrooms, laundries and other wet areas.
- Sealing architectural joints



Available Colours*



Colour	Size	Code
Gloss White	310ml Cartridge	SILZBGLWH/CTG
Antique White	310ml Cartridge	SILZBANWH/CTG
Titanium	310ml Cartridge	SILZBTIT/CTG
Mid Grey	310ml Cartridge	SILZBMIDGR/CTG
Silver Ash	310ml Cartridge	SILZBSILASH/CTG
Charcoal	310ml Cartridge	SILZBCHAR/CTG
Taupe	310ml Cartridge	SILZBTAUP/CTG
Pewter	310ml Cartridge	SILZBPEWTCTG

*Colours are not exact. Colours shown are a representation only. Please refer to the actual product sample.



Available Colours*



Dow Corning 888

Dow Corning 888 Silicone is a low-modulus silicone joint sealant that is suitable for new and remedial joint sealing applications. It provides outstanding UV and weathering resistance and is excellent for joint sealing applications such as highway, airport and bridge joints and environments where high movement occurs.

Features

- + 100 % / -50% joint movement
- Trafficable
- Suitable for saw cuts
- Suitable for roads and runways

Colour	Size	Code
Grey	600ml Sausage	SILDC888/SSG



Available Colours*



Sikasil WS-305CN

Sikasil WS-305 CN is a neutral curing silicone sealant with a high movement capability. It has excellent UV and weathering resistance and is commonly used for weatherproofing and sealing many substrates such as glass, metals, coated and painted metals, plastics and wood.

Colour	Size	Code
Black	600ml Sausage	SIKASILWS305BL



Available Colours*

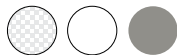

Sikapool

Sikapool is a one-part neutral curing silicone sealant for use in swimming pools and permanently wet areas.

Features

- Very high water resistance
- High chlorine resistance (as required in swimming pools due to use of disinfecting solutions)
- Extremely high resistance to fungal attack
- Excellent UV and weathering resistance
- High tear resistance
- Non-corrosive
- High elasticity and flexibility

Colour	Size	Code
Transparent	300ml Cartridge	SIKAPOLTR/CTG
White	300ml Cartridge	SIKAPOLWH/CTG
Grey	600ml Sausage	SIKAPOLGR/SSG

*Colours are not exact. Colours shown are a representation only. Please refer to the actual product sample.

Adhesives & Sealants

Fire Rated Sealants



Available Colours*



Adheseal Firefill

Firefill is a high performance water based acrylic fire-rated joint sealant.

Features

- Up to 4-hour fire rating (tested in accordance with AS1530 Pt 4: 2014 Section 2,4,10. BS476: Pt 20: 1987: AS4072.1-2005 as appropriate)
- Outstanding UV and weather resistance
- Suitable for exterior and interior applications
- Water clean up
- Easy workability and application
- Joint movement capability +/- 20%
- Paintable
- Excellent adhesion to metal, concrete, plasterboard and cable coverings
- Outstanding acoustic properties
- Low VOC (complies with Green Star VOC)

Applications

- Expansion joints
- Gap sealing wall penetrations such as ducts, pipes or cables
- Expansion and construction joints
- Tilt-up construction
- Brick and blockwork
- Plasterboard
- Fibre cement sheet
- Acoustic sealant (suitable for cinemas and sound booths etc)

Colour	Size	Code
Grey	600ml Sausage	FIREFILL/SSG
Grey	10L Pail	FIREFILL/10



Available Colours*



Bostik Fire Ban 1

Bostik Fireban One is a one part, fire rated, polyurethane joint sealant. When cured it will form a tough, flexible seal with good weather resistance.

Features

- Up to 4-hour fire rating
- Suitable for exterior and interior applications
- Paintable
- Excellent adhesion to metal, concrete, plasterboard and cable coverings
- Excellent acoustic properties

Applications

- Expansion joints
- Tilt-up construction
- Brick and blockwork
- Plasterboard
- Fibre cement sheet
- Acoustic sealant (suitable for cinemas and sound booths etc)

Colour	Size	Code
Grey	600ml Sausage	FIREBAN/SSG



Available Colours*



Sika Firerate PU

Firerate PU is a one component, moisture cure polyurethane joint sealant. It is designed to cure into a fire rated, elastic weatherproof seal.

Features

- Up to 4-hour fire rating
- Suitable for exterior and interior applications
- Paintable
- Excellent adhesion to metal, concrete, plasterboard and cable coverings
- Excellent acoustic properties

Applications

- Expansion joints
- Tilt-up construction
- Brick and blockwork
- Plasterboard
- Fibre cement sheet
- Acoustic sealant (suitable for cinemas and sound booths etc)

Colour	Size	Code
Grey	600ml Sausage	FIRERATEPU/SSG

*Colours are not exact. Colours shown are a representation only. Please refer to the actual product sample.

Adhesives & Sealants

Acrylics / Water Based Sealants



Available Colours*



Everflex 250 JS

Everflex 250 JS is a specially formulated acrylic joint sealant that provides good weather resistance and flexibility in joints and gaps. It has good flexibility (+25%) and is designed for sealing exterior and interior joints that are subject to movement.

Applications

- Precast panels and tilt up construction
- Blockwork
- Brickwork
- Timber
- Metal
- Plasterboard
- Acoustic perimeter sealant
- General cracks and gaps

Colour	Size	Code
Grey	600ml Sausage	EV250JS/SSG
Grey	10L Pail	EV250JS/10



Available Colours*



Everflex JS

Everflex JS is a premium, highly elastic, hybrid acrylic, joint sealant. It has exceptional UV and weathering resistance and excellent adhesion to most building materials whilst still maintaining its superb elasticity.

Features

- Water clean up
- Excellent Slump Resistance
- Capable of + / - 50% Joint Movement
- Superior Adhesion
- Non-Staining
- Non-Toxic
- Non-Hazardous
- No Isocyanates
- Paintable
- Low VOC (complies with Green Star VOC)

Applications

- Precast panels and tilt up construction
- Blockwork
- Brickwork
- Timber
- Metal
- Windows and doors
- Many plastics including Acrylic and Polycarbonate.

Colour	Size	Code
Grey	600ml Sausage	EEVJS/SSG
Grey	10L Pail	EVJS/10



Allflex 101

Allflex 101 is a specialised hybrid acrylic joint sealant which has exceptional resistance to weathering. It cleans up easily with water and has superb adhesion and elasticity. It is commonly used as an alternative to silicone sealants in applications such as beading glass into timber in glazing and timber joinery.

Features

- Excellent Weathering
- Water clean-up
- Non-Staining
- Non-Toxic
- Paintable
- Non-Hazardous
- Superior Adhesion (no priming)
- Low VOC (complies with Green Star VOC)
- UV Resistant

Colour	Size	Code
Clear	300ml Cartridge	ALLFLCLR/CTG

Adhesives & Sealants

Flooring Adhesives



Adheseal Parquetry PS1300

Parquetry PS1300 is a premium, flexible, MS polymer based timber flooring adhesive that contains neither isocyanates nor silicones. It can be used to adhere most types of wood, parquetry strip and sheet timber flooring systems to concrete, timber and over existing floors.

Features

- Single component
- Low modulus
- Easy to use
- No isocyanates
- Excellent bond strength and flexibility
- Low VOC (complies with Green Star VOC)

Colour	Size	Code
Beige	21kg Pail	PARQ/21



Adheseal PU50 Parquetry

PU50 Parquetry is a flexible one component, moisture curing, polyurethane, timber flooring adhesive. It will adhere most types of wood, parquetry, strip and sheet timber flooring systems to concrete, timber and over existing floors.

Features

- Easy to spread
- Gun Grade
- Medium modulus
- Remains flexible
- Excellent bond strength
- Low VOC (complies with Green Star VOC)

Colour	Size	Code
Grey	600ml Sausage	PARQ/SSG



Bostik Ultraset SF

Ultraset SF is a flexible one component, moisture curing, polyurethane, timber flooring adhesive. It is formulated to adhere most types of wood, parquetry, strip and sheet timber flooring systems to concrete, timber and over existing floors.

Features

- Easy to spread
- Low modulus
- Remains flexible
- Excellent bond strength

Colour	Size	Code
Brown	600ml Sausage	ULTRASET/SSG
Brown	16kg Pail	ULTRASET/16



Adheseal Everbond SG

Everbond SG is a synthetic rubber based adhesive that is particularly suited for interior and exterior carpet as well as synthetic grass laying applications.

Colour	Size	Code
Green	20L Pail	EVERBOND/SG/20

Sikabond T55J

SikaBond-T55 (J) is a one-part polyurethane adhesive for direct elastic bonding of timber floors. It adheres to most types of wood, parquet, strip and sheet timber flooring systems to concrete, timber and over existing floors.



Features

- One part, easy to use
- Low modulus
- Excellent elasticity
- Quick tack free time

Colour	Size	Code
Brown	600ml Sausage	SIKAT55J/SSG
Brown	16kg Pail	SIKAT55J/16

Adheseal Multi-Grip Construction Adhesive

Newly formulated premium grade solvent free Builder's Nails with outstanding initial grab properties.



Features

- Suitable for interior and exterior applications
- Paintable
- High initial grab
- Does not become brittle
- Water clean up
- Excellent UV resistance
- Complies with Green Star VOC

Applications

- General purpose construction adhesive
- General purpose gap filling
- Bonding timber to studs and joists
- Flooring and wall systems
- Bonding timber, metal concrete and most common construction materials
- Cornice adhesive
- Installation of wall sheeting, internal and external mouldings
- Bond polystyrene foam components





Colour	Size	Code
White	600ml Sausage	MULTIGRIP/SSG



Multi-Tack

Builders' Nails / Gap Filler / Joint Sealant





Low VOC



3 in 1 Multi-Use

High Strength Construction Adhesive

Multi-Tack is a newly formulated, green star compliant, solvent free multi purpose construction adhesive, ideal for use as an adhesive, joint sealant or gap filler.



Internal & external use



Flexible



Water cleanup



Paintable



High initial grab



UV stable

Adheseal

Hi-Power

Automotive / Construction / Industrial / Marine

Extreme Strength Structural Adhesive



Low
VOC



Solvent
Free



Isocyanate
Free



Easy tooling &
finishing



Excellent colour
stability



Excellent primer-less
adhesion



Internal & external
applications



Paintable



Excellent UV
resistance

Adheseal Hi-Power is a hybrid adhesive with outstanding initial grab strength. It is a powerful structural strength adhesive that can be used for bonding materials exposed to extreme applications such as vibrations or deformation in building and industrial applications.

Features

- High performance adhesive
- Very high flexible bond strength
- Exceptional green strength
- Excellent sheer strength
- Does not contain isocyanates, silicone or solvent
- Tough and durable
- Easy to tool and finish
- Excellent colour stability and UV resistance
- Paintable (instantly with most paints)
- Exceptional weather resistance



Adheseal
The Adhesive and Sealant Specialists

Adheseal Head Office
26 Wolverhampton Street
Stafford, Queensland 4053
Phone: (07) 3356 0000
sales@adheseal.com.au

Adheseal Sunshine Coast
2/18 Kessling Ave
Kunda Park, Queensland 4556
Phone: (07) 5477 0022
sc@adheseal.com.au

Adhesives & Sealants
PVA Glues



General Purpose PVA - Everbond

A commercial grade, PVA based adhesive suitable for general interior woodworking and joinery applications.

Features

- High strength
- Clear drying
- Non-toxic
- Non-staining
- Water clean up

Size	Code
5L	PVAGP/5
20L	PVAGP/20
200L	PVAGP/200



Melamine PVA Adhesive - Everbond

A water-borne synthetic resin for bonding difficult surfaces in shop-fitting, joinery and kitchen applications. Melamine adhesive is commonly used for bonding melamine-laminated boards to timber and end-grain particleboard. It has excellent adhesion to a wide variety of difficult to bond substrates such as timbers, ceramics and several plastics.

Size	Code
5L	PVAMEL/5
20L	PVAMEL/20
200L	PVAMEL/200



Cross Link PVA Adhesive - Everbond

A premium quality, water resistant cross linking PVA adhesive that is used when a higher strength bond is required. It is suitable for both internal and external applications.

Features

- High strength
- Sandable
- Fast setting
- Dries clear
- Water clean-up
- Water resistant (D3 standard)
- Suitable for interior & exterior applications

Size	Code
5L	PVAXL/5
20L	PVAXL/20
200L	PVAXL/200



Cross Link 3500 Roller Grade PVA - Everbond

A high performance, lower viscosity, cross-linking PVA adhesive commonly used for laminating, door pressing and veneering applications.

Size	Code
20L	PVAXLRG/20
200L	PVAXLRG/200

*Colours are not exact. Colours shown are a representation only. Please refer to the actual product sample.

Adhesives & Sealants

Contact Adhesives



SP-230 Spray Contact Adhesive - Everbond

A premium spray contact adhesive with very high heat resistance and fast initial grab.

Uses

- Bonding laminates in cabinet making and shop-fitting applications
- Motor and marine trimming applications
- Bonding surfaces such as timber, MDF and particleboard, metal, urethane foam, cloth backed and polyester backed vinyl, leather, carpet and polyurethane foam in motor trimming applications

Size	Colour	Code
20L	Natural	CONTSP230N/20
200L	Natural	CONTSP230N/200
20L	Red	CONTSP230R/20
200L	Red	CONTSP230R/200



Brush Contact Adhesive - Everbond

A brush contact adhesive with high heat resistance and fast initial grab.

Suitable for

- Timber, MDF and particleboard
- Metal
- Urethane foam
- Cloth backed and polyester backed vinyl
- Leather
- Carpet
- Polyurethane foam in motor trimming applications

Size	Colour	Code
1L	Natural	CONTRUSH/1
4L	Natural	CONTRUSH/4
20L	Natural	CONTRUSH/20



Ultra-Clear Brush Contact Adhesive - Everbond

A high performance, clear, brushable contact adhesive designed for applications where glue lines are preferred not to be visible. It is commonly used in applications such as the manufacturing process of neoprene drink coolers.

Size	Colour	Code
20L	Ultra Clear	CONTRUSHCL/20



Styrobond ST Contact Adhesive - Everbond

A specialised spray contact adhesive designed for bonding polystyrene foam to hardboard, aluminium and surfaces that may be affected by the solvents in standard contact adhesives.

Size	Colour	Code
20L	Natural	STYROSTN/20
200L	Natural	STYROSTN/200
20L	Green	STYROSTGR/20
200L	Green	STYROSTGR/200



Beading Adhesive - Everbond

A natural rubber based adhesive suitable for bonding surfaces such as leather, rubber, and many other materials, where a soft bond is initially required. Beading adhesive has good initial tack and bonding strength and has good resistance to water, humidity, detergents, non-aromatic fuels, oils and ageing.

Suitable applications

- Assembling Leather Jackets, where some re-positioning may be required
- Attaching sanding discs, or other 'temporary' bonding situations

Size	Colour	Code
20L	Translucent	BEADING/20



2P Contact Adhesive Additive - Everbond

A crosslinking additive that is designed to increase the bond strength, heat resistance and water resistance of suitable contact adhesives. It is ideal for bonding rubber and specialised applications.

Size	Code
50ml	CONT2P/50



Unobond

Woodworking / Outdoor / Marine



Super Strength Polyurethane Adhesive

Unobond is a single component, quick setting, moisture cured polyurethane adhesive. Commonly used for structural applications. It has excellent water resistance and provides an extremely strong structural bond.

- 
Low VOC
- 
Solvent Free
- 
Fast Setting
- 
Heat resistant
- 
Acid & chemical resistant
- 
Classified D4 water resistant
- 
Paintable and sandable
- 
Super strong bond
- 
Structural strength



Adheseal

Cordless Caulking Gun

Professional / Lithium Ion Power

The Adheseal Cordless Caulking Gun is designed with the user in mind. Light weight for easy use and dual flow controls deliver a smooth and steady action for precise application.



The professionals' choice

Features

- Anti drip mechanism
- Low power consumption
- High output thrust
- Variable speed trigger
- Maximum speed control
- LED auxiliary light
- Light weight

Kit contains

- 600ml sausage sealant gun
- 2 x lithium ion batteries
- Battery charger
- Carry case



Adheseal
The Adhesive and Sealant Specialists

Adheseal Head Office
26 Wolverhampton Street
Stafford, Queensland 4053
Phone: (07) 3356 0000
sales@adheseal.com.au

Adheseal Sunshine Coast
2/18 Kessling Ave
Kunda Park, Queensland 4556
Phone: (07) 5477 0022
sc@adheseal.com.au

www.adheseal.com.au

Adhesives & Sealants

Megapoxy Epoxies / Grouts / Pigments

Megapoxy

OFFICIAL DISTRIBUTOR



Adheseal has proudly been the official Queensland distributor of Megapoxy products since 1989.

Regarded as Australia's top selling construction epoxy products, Megapoxy is used extensively across a wide range of industries in Australia and global markets and has been providing effective adhesive solutions for over thirty years.

Currently there are over 300 Megapoxy products available such as construction adhesives for manufacturing, surface coatings, industrial compounds for civil engineering, mining, electrical and general manufacturing industries. Listed below are the most common Megapoxy products used. Ask your Adheseal representative which product best suits your application.

Megapoxy Megabond

Structural Epoxy Paste Adhesive

Features

- Suitable for bonding stone and tile to masonry surfaces
- Creamy white colour
- Can be coloured using Megapoxy coloured pigment pastes
- Easy to mix and spreads readily with a notched trowel
- High impact and chemical resistance

Colour	Size	Code
Grey	4L Kit	MPMEGAB/4
Grey	20L Kit	MPMEGAB/20

Megapoxy P1

Gap Filling / Structural Epoxy Adhesive Paste

Features

- Ideal for concrete structural bonding, filling and repair applications
- Commonly used in pipeline and civil construction
- Suitable for potable water applications
- 60 minute work time / 24 hour cure time

Colour	Size	Code
Grey	1L Kit	MPP1/1
Grey	4L Kit	MPP1/4
Grey	20L Kit	MPP1/20

Megapoxy 69

High Strength Impact Resistant Epoxy Gel / Liquid Adhesive

Features

- Translucent non-sag gel type epoxy
- Ideal for structural bonding to metals, concrete, masonry, timber, assembly of granite and marble fabrications, and many other civil engineering applications
- Suitable for timber joinery and in the marine environment applications
- Structural bond strength
- Retains its high strength after repeated high impact forces

Colour	Size	Code
Opaque Gel	1L Kit	MP69/1
Opaque Gel	4L Kit	MP69/4
Opaque Gel	20L Kit	MP69/20
Opaque Liquid	4L Kit	MP69LQ/4
Opaque Liquid	20L Kit	MP69LQ/20

Megapoxy 84

Epoxy Paste Adhesive for Ceramic Tile Linings

Features

- Suitable for fixing high alumina ceramic tile linings to steel or concrete for applications where elevated temperatures will be encountered

Colour	Size	Code
Pail Blue	2.5L Kit	MP84/2.5

Megapoxy PM *(Paste, medium work time)*

Gap Filling / Structural Adhesive Epoxy Paste Adhesive

Features

- Commonly used for structural bonding, gap filling and repairs on concrete, marble and granite and other construction materials.
- Tensile and compressive strength superior to concrete
- Very good chemical resistance
- 45 minute work time / 24 hour cure time

Colour	Size	Code
Natural (white)	1L Kit	MPPMWH/1
Grey	4L Kit	MPPMGR/4
Natural (white)	4L Kit	MPPMWH/4
Grey	20L Kit	MPPMGR/20
Natural (white)	20L Kit	MPPMWH/20

Megapoxy PF *(Paste, fast work time)*

Rapid Set Gap Filling / Structural Epoxy Paste / Gel / Liquid Adhesive

Features

- Commonly used for structural bonding, gap filling and repairs on concrete, marble and granite and other construction materials.
- Suitable for immediate on the spot emergency repairs to tanks, pipes, machinery, concrete structures
- Tensile and compressive strength superior to concrete
- Very good chemical resistance
- 5 minute work time / 60 minute cure time

Colour	Size	Code
Natural (white)	1L Kit	MPPFWH/1
Grey	4L Kit	MPPFGR/4
Natural (white)	4L Kit	MPPFWH/4
Grey	20L Kit	MPPFGR/20
Natural (white)	20L Kit	MPPFWH/20
Opaque Gel	4L Kit	MPPFGEL/4
Opaque Gel	20L Kit	MPPFGEL/20
Opaque Liquid	4L Kit	MPPFLIQ/4
Opaque Liquid	20L Kit	MPPFLIQ/20

Megapoxy H

Low Viscosity Hydrophilic Epoxy Resin Liquid

Features

- High strength epoxy for bonding and anchoring steel reinforcement, starter bars and tie bars into concrete, brick work and stone
- Wet to dry binding agent (new to old concrete)
- Suitable for use in damp conditions
- Ideal for sealing and/or waterproofing concrete structures and can be mixed with sand to make epoxy mortar systems
- Addition of pigments can also be added for industrial floor coatings

Colour	Size	Code
Natural (Clear)	4L Kit	MPH/4
Natural (Clear)	20L Kit	MPH/20
Grey N35	4L Kit	MPHGR/4
Grey N35	20L Kit	MPHGR/20
Pacific Blue	4L Kit	MPHPB/4
Pacific Blue	20L Kit	MPHPB/20

Megapoxy H Rapid

Rapid Set Low Viscosity Hydrophilic Epoxy Resin Liquid

Features

- Rapid set high strength epoxy for repairs and coatings in areas where prolonged shutdowns or interruptions to traffic are not desired
- Suitable for use in damp conditions
- Ideal for sealing and/or waterproofing concrete structures and can be mixed with sand to make mortar systems
- Addition of pigments can also be added for industrial floor coatings
- Pot life 8 minutes / Initial cure 30 - 45 minutes

Colour	Size	Code
Natural (Clear)	4L Kit	MPHRAP/4
Natural (Clear)	20L Kit	MPHRAP/20

Megapoxy HT

Non-Sag Hydrophilic Epoxy Resin

Features

- High strength epoxy
- Suitable for applications overhead, vertical or inclined surfaces
- Suitable for use in damp conditions
- Non-sag characteristic assists greatly in underwater applications

Colour	Size	Code
Grey	4L Kit	MPHT/4
Grey	20L Kit	MPHT/20

Megapoxy HX

Extra Low Viscosity Hydrophilic Epoxy Resin Liquid

Features

- Suitable for repair of cracked concrete by gravity penetration or low pressure injection impregnation of porous substrates such as masonry and timber
- Suitable for use in damp conditions

Colour	Size	Code
Natural (Extra Clear)	4L Kit	MPHX/4
Natural (Extra Clear)	20L Kit	MPHX/20

Megapoxy 132

Chemical Resistant Epoxy Coating

Features

- Megapoxy 132 is a two-component solvent-less 100% solids epoxy resin
- Heavy duty, protective, chemical resistant epoxy coating suitable for decorative floor and wall cladding
- Suitable for garage floors, warehouse or factory floors and can also be used to create a trowel-able mortar for screeding floors

Colour	Size	Code
Clear	15L Kit	MP132CL/15
Clear	30L Kit	MP132CL/30
Grey - N35	15L Kit	MP132GR/15
Grey - N35	30L Kit	MP132GR/30

Megapoxy 154

High Solids Water Based Liquid Epoxy

Features

- Forms a tough impervious coating with a matte finish
- Excellent adhesion to wet or dry surfaces including freshly poured concrete
- Commonly used as a vapour barrier on decks and balconies
- Non-flammable / non-toxic
- Cleans up with water

Colour	Size	Code
Grey	20L Kit	MP154/20

Megapoxy L

Multipurpose Liquid Epoxy

Features

- Commonly used for rail and machinery grouting, wear and slip resistant floors, bridge load bearing pads and repair of broken concrete
- Typically mixed with sand for high build structural grouting of machinery

Colour	Size	Code
Clear	18L Kit	MPL/18

Megapoxy HICB

High Impact Crusher Backing

Features

- Epoxy grout for backing crusher parts, grouting machinery, locking bearings, setting anchor bolts and chocking of machinery
- Outstanding compressive strength properties with very low shrinkage

Colour	Size	Code
Blue	10kg Kit	MPHICB/10

Megapoxy MC

Heavy Duty Protective Coating

Features

- Excellent heavy duty protective coating of concrete, steel, timber, masonry etc
- Ideal coating of storage tanks for chemicals, foodstuffs, fuel, garage floors, warehouse floors, pools and more
- Resistant to abrasion, impact and wide range of chemicals (chemical resistance chart available on data sheet)
- Can be applied by airless spray equipment, roller or brush
- Working time approximately 2 hours
- Custom colours available with small batches

Colour	Size	Code
White	5kg Kit	MPMCWH/5
Grey	5kg Kit	MPMCGR/5
Koala Grey	5kg Kit	MPMCKOGR/5
Dark Grey	5kg Kit	MPMCDKGR/5
Pacific Blue	5kg Kit	MPMC PB/5
Safety Yellow	5kg Kit	MPMCYELL/5
Black	5kg Kit	MPMCBLK/5

Megapoxy Megaprene Hot Melt

Joint Sealant

Features

- High movement sealant for horizontal joints in asphaltic and cement concrete, ceramic tiled surfaces and timber decks
- Commonly used for sealing expansion joints in bridges, roads and carparks

Colour	Size	Code
Black	20kg Kit	MPHMELT/20

Megapoxy 57

Heavy Duty Epoxy Grout

Features

- Epoxy grout, suitable for grouting machinery, locking bearings, setting anchor bolts, chocking of machinery, rail track grouting, and bridge bearing pads

Colour	Size	Code
Green	9.4kg Kit	MP57/9

Megapoxy 206

High Strength Epoxy Grout

Features

- Epoxy grout, suitable for grouting machinery, locking bearings, setting anchor bolts, chocking of machinery, rail track grouting, and bridge bearing pads

Colour	Size	Code
Grey	6L Kit	MP206/6

Megapoxy 108

Rapid Set Liquid Binding Epoxy for Pile Splicing

Features

- Typical application is splicing of bridge piles where fast development of high compressive and impact strength is required
- For civil engineering applications where early development of high strength is essential

Colour	Size	Code
Clear Liquid	6L Kit	MP108/6
Clear Liquid	18L Kit	MP108/18

Megapoxy E

High Impact Epoxy for Electrical Castings for Room or Elevated Temperature Service

Features

- Recommended for encapsulation of instrument and lighting transformers, small power transformers and coils, casting electrical switchgear components and for mechanical, chemical resistant applications
- Cured, it has excellent static and dynamic mechanical properties
- Superior electrical and dielectric properties

Colour	Size	Code
Grey	6kg Kit	MPE/6
Grey	30kg Kit	MPE/30

Megapoxy LVS

Low Viscosity Sealer

Features

- Penetrative sealer for concrete, brick and other porous surfaces
- Recommended as a primer for use with Megapoxy MC

Colour	Size	Code
Clear	15L Kit	MPLVS/15

Megapoxy CT5

Installation Compound for Airport Lighting and Inductive Detector Loops

Features

- Cold pour compound for backfilling and encapsulating inductive detector loops, weigh in motion sensors, and aircraft landing lights on asphaltic and concrete roadways
- Sets rapidly in all weather conditions properties

Colour	Size	Code
Black	20L Kit	MPCT5/20

Megapoxy 34

100% Solids Epoxy Resin Formulation

Features

- Recommended for underground cable jointing, encapsulation of instrument transformers, lighting transformers, small power transformers and coils, casting electrical switchgear components
- Suitable for mechanical and chemical resistant applications
- Excellent static and dynamic mechanical properties
- Superior electrical and dielectric properties

Colour	Size	Code
Clear	18kg Kit	MP34/18

Megapoxy 36

Gun Grade Epoxy Adhesive for Bituminous and Concrete Surfaces

Features

- Recommended for bonding reflective markers and other objects to bituminous and concrete surfaces

Colour	Size	Code
Grey	600ml Twin Cartridge	MP36/600
Grey	4L Kit	MP36/4
Grey	20L Kit	MP36/20

Megapoxy 260

Solvent-less Flexible Epoxy Resin

Features

- Suitable for control construction joints, cracks and high impact applications
- Recommended for sealing constructions joints, factory floors, parking structures, warehouse floors, ramps, driveways and more

Colour	Size	Code
Clear	2.5kg Kit	MP260/2.5

Adheseal

Everflex Primer Range

Primers for waterproofing applications

High Performance Everflex Primers



Showers



Decks



Roofs



Everflex WBP Water Based Primer

A waterborne, polymer based primer commonly used in internal wet areas and confined unventilated spaces designed to penetrate porous surfaces prior to the application of waterborne waterproofing membranes.

Uses:

- Internal wet areas
- Masonry surfaces
- Fibre-cement sheeting
- Plasterboard



Everflex SBP Solvent Based Primer

A solvent based, penetrative acrylic primer for water based and polyurethane waterproofing membranes and coatings on to porous substrates.

Uses:

- Internal wet areas and exterior applications
- Showers
- Balconies & decks
- Masonry surfaces
- Fibre-cement sheeting
- Plasterboard



Everflex VBS Vapour Barrier System

A high performance two-part, waterborne epoxy primer and sealer with outstanding bonding properties to porous and semi-porous surfaces.

Uses:

- Internal wet area and external applications
- Balconies, decks & roofs
- Retaining walls
- Vapour barrier for rising damp
- Where resistance to positive and negative hydrostatic pressure is required
- Masonry surfaces
- Fibre-cement sheeting
- Plasterboard
- Timber
- Bituminous surfaces

Adheseal
The Adhesive and Sealant Specialists

Adheseal Head Office
26 Wolverhampton Street
Stafford, Queensland 4053
Phone: (07) 3356 0000
sales@adheseal.com.au

Adheseal Sunshine Coast
2/18 Kessling Ave
Kunda Park, Queensland 4556
Phone: (07) 5477 0022
sc@adheseal.com.au

www.adheseal.com.au

Adheseal
Primers



Everbond WBP Primer - Adheseal

A waterborne, polymer based primer commonly used on internal wet areas. WBP Primer is designed to penetrate porous surfaces and promote adhesion to substrates prior to the application of waterborne waterproofing membranes. It has very low VOCs and meets criteria Green Star standards.

Applications

- Internal wet areas
- Adhesion promoter for:
 - Masonry surfaces
 - Fibre-cement sheeting
 - Plasterboard
 - Brick

Compatible Membranes Include

- Everflex UTM
- Everflex WPM
- Everflex WPUV

Colour	Size	Code
Clear	4L	PRIMEWBP/4
Clear	15L	PRIMEWBP/15



WB Primer - Duram

A water based, concrete compatible, polymer emulsion commonly used in internal wet areas. WB primer is designed to enhance the adhesion of Duram membranes such as Durabit EF, Durabit Reo and Azcothane.

Colour	Size	Code
Clear	4L	PRIMEWBD/4
Clear	15L	PRIMEWBD/15



Primer G - Mapei

Synthetic resin based primer in water dispersion that improves bonding to porous surfaces such as cement and gypsum prior to installing ceramic tiles and stone materials with cementitious adhesives or levelling compounds.

Colour	Size	Code
Light Blue	5kg	PRIMEG/5
Light Blue	10kg	PRIMEG/10
Light Blue	25kg	PRIMEG/10



Eco Prim T Plus - Mapei

An acrylic bonding primer suitable for interior applications to improve adhesion of levelling compounds on porous and non-porous surfaces.

Colour	Size	Code
White	5kg	PRIMEECOT/5
White	20kg	PRIMEECOT/20

Eco Prim Grip

Multi-Purpose Bonding Primer



- Multi-purpose internal/external rough coat bonding primer
- **One part**, ready-to-use and contains no solvents
- **One (1) coat application - ready to cover in approx. 30 minutes**
- Provides rough mechanical key prior to the application of renders, levelling compounds and adhesives on existing non-porous surfaces
- Ideal for installing tile or levelling compounds over existing tiles
- Suitable for use on floors and walls

Available in 5kg and 10kg buckets

ECO PRIM GRIP	
Pot life	ready-mixed
Drying time	15 - 60 minutes
Application temperature	from +5°C - +35°C
Application types	brush or roller
Colour	grey
Shelf life	12 months
Packaging	5kg and 10kg buckets
Consumption	0.20 - 0.30 kg/m ²
VOC content	0 g/l



Scan to download technical data sheet





Eco Prim Grip - Mapei

A multi-purpose, ready-to-use internal / external rough coat bonding primer that provides a mechanical key prior to the application of renders, levelling compounds and adhesives on existing non-porous surfaces floors. It is ideal for use on existing tiles and is suitable for both floor and wall applications.

Colour	Size	Code
Grey	5kg	PRIMEECOG/5
Grey	20kg	PRIMEECOG/20



ARW - Durotech

A water based primer used to prime concrete, masonry and fibre cement sheeting surfaces. When dry, it forms a pink sealed surface suitable for the application of water based membranes.

Colour	Size	Code
Pink or Clear	4L	PRIMEARW/4
Pink or Clear	20L	PRIMEARW/20



Special Surface Primer - Durotech

A waterborne primer designed to promote adhesion of waterproofing membranes and coatings to previously tiled or other difficult surfaces such as glazed tile, glass, sandstone, non-ferrous metals, galvanised steel, aluminium and mineral surfaces etc.

Colour	Size	Code
Pink	4L	PRIMESSP/4
Pink	20L	PRIMESSP/15



Multiprime - ASA

General purpose primer designed for use on porous surfaces. Compatible with ASA tile adhesives and most Bostik waterproofing membranes. Suitable for interior and exterior applications.

Colour	Size	Code
Pink	20L	PRIMEMULTI/20



Everbond SBP Primer - Adheseal

A solvent based, penetrative acrylic primer for water based and polyurethane waterproofing membranes and coatings on to porous substrates. SBP is suitable for use on concrete, cement, cement render, FC and CFC sheeting, blue board, block work, bricks, cement pavers and masonry surfaces.

Compatible Membranes Include:

- Everflex UTM
- Everflex WPM
- Everflex WPUV

Colour	Size	Code
Clear	4L	PRIMESBP/4
Clear	15L	PRIMESBP/15



50a Primer - Adheseal

A clear solvent based primer/cleaner designed to promote the adhesion of polyurethane MS polymer sealants to non-porous substrates such as rigid plastics and most metals.

Colour	Size	Code
Clear	250ml	PRIME50A/250
Clear	1L	PRIME50A/1



2001 Primer - Adheseal

A primer designed to enhance adhesion of polyurethane and MS polymer sealants to porous substrates such as concrete & masonry.

Colour	Size	Code
Clear	250ml	PRIME2001/250
Clear	1L	PRIME2001/1



Azcoseal - Duram

A premium clear acrylic solvent based solution capable of deep penetration into a wide range of substrates. It is suitable as a primer for water based and polyurethane waterproofing membranes and high build paints and coatings and is particularly useful in high density and low-porosity surfaces such as tilt-up slabs. Suitable for use on concrete, cement, cement render, FC and CFC sheeting, blue board, block work, bricks, cement pavers, sandstone, concrete stencil and masonry surfaces.

Colour	Size	Code
Clear	4L	PRIMEAZCO/4
Clear	15L	PRIMEAZCO/15



Superprime 711 - Duram

Polyurethane based, bonding agent and adhesion promoter for various Duram coatings and membranes on to PVC, fibre-glass and various composite boards. It can also be used to bond water-based membrane to polyurethane based membranes.

Colour	Size	Code
Clear	4L	PRIMESUP/4



N40 Primer - Bostik

A clear solvent based primer/cleaner for promoting the adhesion of polyurethane and acrylic sealants and waterproof membrane systems to non-porous substrates such as rigid plastics and most metals.

Colour	Size	Code
Clear	1L	PRIMEN40/1



N49 Primer - Bostik

Bostik N49 Primer is designed for use with the Bostik Polyurethane sealant range to ensure adhesion to porous substrates.

Colour	Size	Code
Clear	1L	PRIMEN49/1
Clear	4L	PRIMEN49/4

Adheseal

PU-25FC

The Waterproofer's Choice

**Easy Gunning.
Fast Cure.**



Fast Cure Sealant for Fillet Joints Under Waterproofing & Coatings



Everbond VBS Primer - Adheseal

A high performance two-part, waterborne epoxy primer and sealer with outstanding bonding properties to porous and semi-porous surfaces.

Features/Applications:

- General primer for waterproofing membranes and coatings
- Vapour barrier for rising damp - minimising the risk of bubbles forming underneath membranes
- Priming and sealing of concrete, cement, cement render, timber, brick, block work, FC sheeting, CFC sheeting, plasterboard and bituminous surfaces
- Provides good resistance to positive and negative hydrostatic pressure

Colour	Size	Code
Clear	4L Kit	PRIMEVBS/4
Clear	20L Kit	PRIMEVBS/20



154 Epoxy - Megapoxy

A premium high solids two-part, water based epoxy commonly used as a primer and sealer with outstanding bonding properties to porous surfaces.

Features/Applications:

- Commonly used as a primer / vapour barrier for membranes and coatings on decks and balconies - minimising the risk of bubbles forming underneath membranes
- Priming and sealing of many common construction surfaces such as concrete, cement, cement render, timber, brick, block work, FC sheeting, CFC sheeting, plasterboard.
- Provides outstanding resistance to positive and negative hydrostatic pressure
- Excellent adhesion to wet or dry surfaces including freshly poured concrete
- Non-flammable / non-toxic
- Cleans up with water

Colour	Size	Code
Grey	20L Kit	MP154/20



Primeseal - Duram

A two-part, water based coating suitable for most types of porous and semi-porous surfaces. Primeseal can be used as a primer and a sealer and is suitable for all Duram waterproofing membranes, anti-slip coatings, paints and coatings. It has excellent bonding properties to most substrates and assists in the prevention of water vapour transmission from the substrate thereby minimising the risk of bubbles forming underneath membranes.

Features/Applications:

- A general and universal primer for most types of substrates
- A vapour transmission barrier
- Priming and sealing of concrete, cement, cement render, timber, brick, block work, FC sheeting, CFC sheeting, plasterboard and bituminous surfaces
- Provides good hydrostatic resistance to both positive and negative waterproofing

Colour	Size	Code
Clear	4L Kit	PRIMESEAL/4
Clear	20L Kit	PRIMESEAL/20



Bostik Moisture Seal

A two component, high performance, water-based epoxy. Moisture Seal will provide a waterproof vapour barrier membrane for most common porous surfaces.

Colour	Size	Code
Green	10L	PRIMEMOIS/10

Adheseal

Everflex UTM

Showers / Balconies / Decks

High Performance Waterproofing Membrane



Showers



Decks



Internal & external applications



Low VOC



Non Toxic



Highly flexible (Class 3)



Rapid Drying



Micro Fibre Reinforced



Water Clean Up



Tough & Durable

A high performance waterborne flexible (class 3) SBR latex/co-polymer waterproofing membrane suitable for internal and external under tile applications. UTM is low VOC and complies with AS4858.

Features

- Fast drying
- High flexibility
- Tough and durable
- Low VOC – Green star compliant
- Non Toxic
- Water clean up
- Compatible with all common building materials
- Complies with the requirements of AS4858 (Class 3) and AS3740

Compatible Primers

- Everflex WB Primer - Internal wet area applications
- Everflex SBP Primer - Internal wet areas and suspended external applications
- Everflex VBS Primer - External decks and balconies



Adheseal
The Adhesive and Sealant Specialists

Adheseal Head Office
26 Wolverhampton Street
Stafford, Queensland 4053
Phone: (07) 3356 0000
sales@adheseal.com.au

Adheseal Sunshine Coast
2/18 Kessling Ave
Kunda Park, Queensland 4556
Phone: (07) 5477 0022
sc@adheseal.com.au

Adheseal

Waterproofing Membranes

LOW VOC

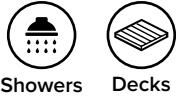

Everflex UTM - Adheseal

A high performance waterborne flexible (class 3) SBR latex/copolymer waterproofing membrane suitable for internal and external under tile applications. UTM is low VOC and complies with AS4858.

Applications

- Wet areas, shower recesses, bathrooms, laundries and toilets
- Patios, terraces, decks and balconies which are to be topped or tiled

Features

- Rapid drying
- High flexibility
- Tough and durable
- Low VOC - Green star compliant
- Non Toxic
- Water clean up
- Compatible with all common building materials
- Complies with the requirements of AS4858 (Class 3) and AS3740

Compatible Primers

- Everflex WB Primer - Internal wet area applications
- Everflex SBP Primer - Internal wet areas and suspended external applications
- Everflex VBS Primer - External decks and balconies

Approximate Coverage

- 1 x 15 litre pail = 10m² (2 coats)

Colour	Size	Code
Blue	15L	UTMBL/15
Grey	15L	UTMGR/15



Everflex WPM - Adheseal

A high performance waterborne flexible (class 3), fibre reinforced, waterproofing membrane designed for internal wet areas and non-exposed external applications. WPM is low VOC and complies with AS4858:2010.

Applications

- Wet areas, shower recesses, bathrooms, laundries and toilets
- Patios, terraces, decks and balconies which are to be topped or tiled

Colour	Size	Code
Grey	15L	WPMGR/15
Blue	15L	WPMBL/15



Durabit Reo - Duram

A water-based, reinforced waterproofing membrane designed for both internal wet areas such as bathrooms and external applications such as terraces, decks and balconies which are to be topped or tiled.

Colour	Size	Code
Grey	4L	DURAREOGR/4
Blue	15L	DURAREOBL/15
Grey	15L	DURAREOGR/15



Duromatic P15 - Durotech

A waterborne modified acrylic urethane waterproofing membrane designed for internal wet areas and non-exposed external applications. It is tough and flexible with a high film strength and exceptional elongation and elasticity properties.

Colour	Size	Code
Grey	15L	DUROP15GR/15



Mapegum WPS - Mapei

Flexible liquid membrane for internal wet area waterproofing applications.

Colour	Size	Code
Light Grey	5kg	MAPWPS/5
Light Grey	10kg	MAPWPS/10
Light Grey	25kg	MAPWPS/25



Aqua Defence - Mapei

Ultra-quick drying, flexible liquid membrane for waterproofing internal and external surfaces which are to be topped or tiled.

Advantages

- Recoat in 1 hour (at +23°C and 50% R.H.)
- Tile after 3-4 hours (at +23°C and 50% R.H.)
- Refer to data sheet for application instructions before application

Colour	Size	Code
Light Blue	7.5kg	AQUAD/7.5
Light Blue	15kg	AQUAD/15



Primeseal Rapid - Bostik

A rapid setting water-based waterproofing membrane designed for internal wet areas and balconies. Suitable for internal and external under tile applications.

Advantages

- Recoat in 1 - 2 hours (approximately)
- Tile after 4 hours (approximately)
- Refer to data sheet for application instructions before application

Colour	Size	Code
Blue	15L	PRIMESRAP/15



Sikatite Undertile Rapid - Sika

A rapid setting water-based waterproofing membrane designed for internal wet areas and balconies. Suitable for internal and external under tile applications.

Advantages

- Recoat in 1 hour (approximately)
- Tile after 4 hours (approximately)
- Refer to data sheet for application instructions before application

Colour	Size	Code
Red	4L	SIKAUNDRA/4
Red	15L	SIKAUNDRA/15

Waterproofing system for the installation of Ceramic Tiles on Balconies

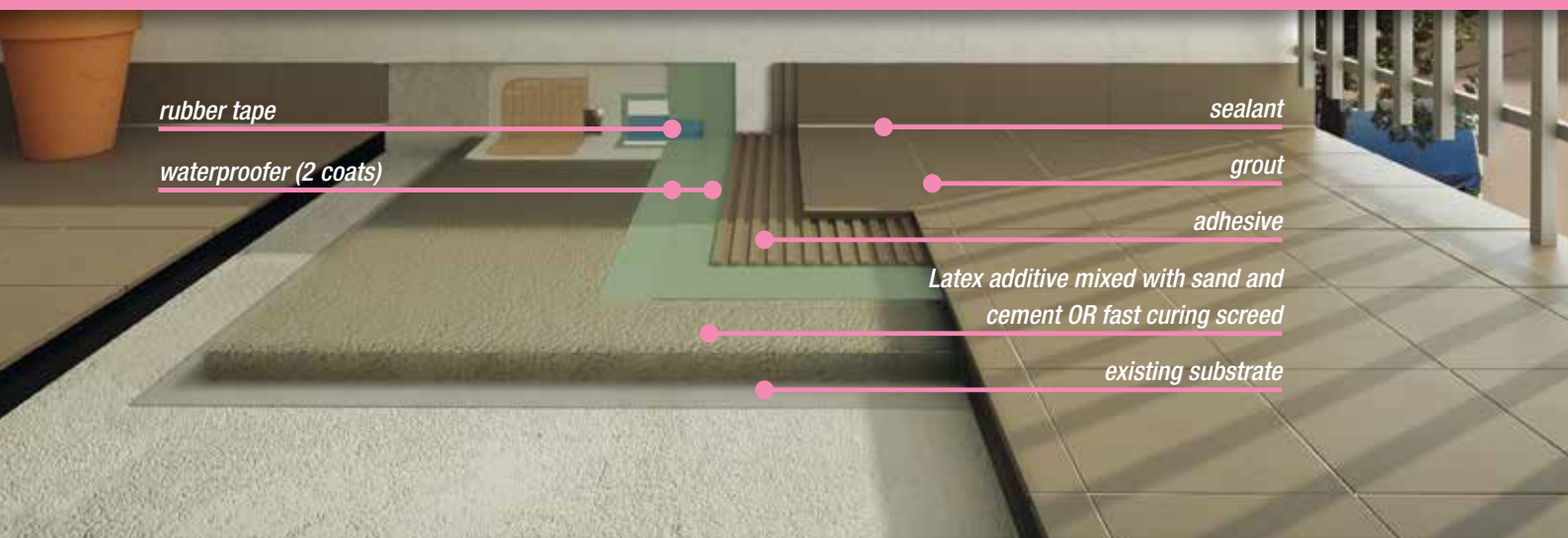

rubber tape

waterproofer (2 coats)

sealant

grout

adhesive

Latex additive mixed with sand and cement OR fast curing screed

existing substrate



screed additive:

Planicrete SP

- latex additive to create mortars, screeds & renders with extremely high bond strength
- once set, mortars show mechanical resistance to shock & vibrations, resistance to water absorption, point load, freeze-thaw cycles, temperature changes, aging & diluted chemical agents
- internal/external use

or

screed:

Mapecem

- fast setting & drying screed
- suitable for floating & bonded screeds on existing & new slabs
- internal/external use
- ready for ceramic or stone tiles after 3-4 hours
- fully cured within 24 hours and ready for timber or vinyl installations



waterproofer:

Mapelastic AquaDefense

- ready to use, solvent free, flexible waterproofing membrane
- internal/external
- ready to tile after 4 hours* (after 2nd coat)
- suitable over plasterboard, concrete, cementitious screeds & render

or

Mapelastic Smart

- 2 component, flexible, cementitious waterproofing mortar
- internal/external
- 2 coat application using brush, roller or trowel
- resistant to alkalis, acids & salt solutions
- suitable for hairline cracks in renders and cementitious surfaces
- suitable for swimming pools, balconies, foundations, retaining walls & potable drinking water



sealant:

Mapesil AC

- solvent-free acetic silicone
- mould and mildew resistant
- high chemical resistance
- internal & external applications
- suitable for swimming pools and bathrooms
- available in 30 colours



adhesive:

Kerabond Plus & Isolastic 50

- cementitious adhesive mixed with a latex additive for superior bond and flexibility
- installation of most types of ceramic, porcelain and non moisture-sensitive stone material
- suitable for large format tiles
- internal/external — wall and floor

or

Keraflex Maxi S1

- polymer modified adhesive
- suitable for large format tiles
- ideal for 3 -15mm bed thickness
- Internal/external — wall and floor



or

Keraquick

- fast setting adhesive
- ready to grout after 2-3 hours*
- installation of all ceramic, porcelain and stone tiles (NOT moisture-sensitive)
- suitable for large format tiles
- internal/external & floor/wall applications



rubber tape:

Mapeband

- rubber tape for the waterproofing between walls & floors, corners & expansion joints on balconies
- Elastic, vapour & water resistant
- resistant to alkalis, acids & salt solutions
- to be used with cementitious & liquid waterproofing membranes
- Mapeband also available in a self-adhesive tape: Mapeband SA



grout:

Ultracolor Plus

- joints 2 - 20mm
- fast drying - foot traffic after 3hrs*
- suitable for all types of ceramic, porcelain and stone material
- suitable for internal/external wall and floor
- anti-efflorescent
- water repellent
- available in 30 colours



* times refer to +23°C and 50% RH

Please refer to relevant product data sheets for further information - available from www.mapei.com.au

Freecall: 1800 652 666

Email: sales@mapei.com.au



Mapelastic AquaDefense

Flexible Waterproofing Membrane



- Ready-to-use, flexible, liquid waterproofing membrane
- Solvent-free
- Ultra-quick drying
- For internal and external waterproofing applications
- Ceramic and stone material may be applied after only 4 hours
- Class III membrane according to AS4858:2004 Wet Area Membranes
- Suitable for Scyon Board (tiling side)

Available in 7.5kg and 15kg drums

MAPELASTIC AQUADEFENSE	CLASS III MEMBRANE
Pot life	ready-mixed
Waiting time between coats	60 minutes
Waiting time before covering	3 - 4 hours
Application temperature	from +5°C - +35°C
Application types	brush or roller
Colour	light blue
Shelf life	24 months
Packaging	7.5kg and 15kg rectangular drums
Consumption	1kg/m ² for two coats
VOC content	54 g/l



Scan to download technical data sheet





Everflex WPUV - Adheseal

A high performance UV stable waterborne polyurethane based waterproofing membrane suitable for internal and external applications. It can be topped, tiled or left exposed and is capable of accommodating expected structural movement. WPUV cures to form a durable, odourless and seamless waterproof membrane with performance that exceeds AS-858:2004.

- Features**
- Fast Drying
 - Excellent UV resistance
 - Fibre reinforced
 - Green Star Compliant
 - Low VOC

- Applications**
- Exposed concrete and metal roofs
 - Balconies, patios and decks to be topped or tiled
 - Window reveals
 - Wet areas, shower recesses, bathrooms, laundries and toilets

- Compatible Primers**
- Everflex WB Primer - Internal wet area applications
 - Everflex SBP Primer - Internal wet areas and suspended external applications
 - Everflex VBS Primer - External decks and balconies

- Approximate Coverage**
- 1 x 15 litre pail = 12m² (2 coats).

Colour	Size	Code
Grey	15L	WPUV/15



Azcothane - Duram

UV resistant, flexible, water-based, polyurethane fortified acrylic emulsion waterproofing membrane formulated for use in exposed, under tile, underground and immersed waterproofing applications.

Colour	Size	Code
Grey (Reinforced)	15L	AZCOTHGR/15
White (Non -Reinforced)	15L	AZCOTHWH/15



Duromastic AC - Durotech

A waterborne UV resistant liquid membrane suitable for internal/external under tile and exposed applications. It cures to form a tough flexible waterproof coating that is resistant to weathering, fungi and algae and is suitable for light foot traffic.

Colour	Size	Code
Grey	15L	DUROACGR/15
White	15L	DUROACWH/15



Aquaflex Roof HR - Mapei

A water based flexible, fibre-filled, UV resistant, liquid membrane suitable for exposed external applications. Aquaflex HR forms a strong, flexible, tack-free dry surface, suitable for occasional light foot traffic.

Colour	Size	Code
White	20kg	AQUAFR/20



Dampfix Gold - ASA

An elastomeric, UV stable, one part, fibre-reinforced water-based polyurethane membrane suitable for both internal and external applications such as wet areas, shower recesses, bathrooms, laundries, toilets, patios, terraces, decks and balconies which are to be topped or tiled.

Colour	Size	Code
Grey	15L	DAMPFGO/15



Sikatite WPU

A water based waterproofing membrane suitable for internal/exposed and undertile external applications.

Colour	Size	Code
Grey	15L	SIKAWPUGR/15
White	15L	SIKAWPUWH/15

Bituminous Liquid Applied Membranes



Bituflex Membrane - Duram

A water-based, single pack, rubberised (latex) bituminous waterproofing compound. Bituflex is an economical general purpose waterproofing membrane suitable for non-exposed applications such as retaining walls and garden features.

Colour	Size	Code
Black	15L	BITUFLEX/15



Plastimul - Mapei

An all-purpose water-based bituminous waterproofing membrane suitable for non-exposed waterproofing applications such as foundations, retaining walls and planter boxes.

Colour	Size	Code
Black	12kg	PLASTIMUL/12
Black	20kg	PLASTIMUL/20



Sikatite BE - Sika

An acrylic based bitumen waterproofing membrane designed for underground use such as retaining walls and planter boxes.

Colour	Size	Code
Black	4L	SIKABE/4
Black	15L	SIKABE/15



Multithane HV - Duram

A high viscosity, tough, durable, elastomeric (class 3), liquid applied, moisture curing, polyurethane waterproofing membrane suitable for above and below ground applications. Multithane HV has excellent bond strength to most primed common building substrates and is suitable for internal and external applications.

Applications

- Tiled or covered areas
- Shower recesses and wet areas (floors and upturns)
- Decks, balconies, terraces & podiums
- Retaining walls
- Planter boxes and landscaped areas
- Structural slabs
- Tanks, pits and water retaining structures

Colour	Size	Code
Grey	15L	MULTITHHV/15



Multithane STD - Duram

A low viscosity, high performance, single component, liquid applied, elastomeric (class 3) polyurethane membrane that cures rapidly to form a tough flexible waterproof lining. Multithane STD has excellent bond strength to most primed common building substrates and is suitable for both internal and external applications.

Applications

- Shower recesses and wet areas (floors and upturns)
- Reinforced concrete and fibrous cement sheeting floors in bathrooms and laundries
- Waterproofing beneath screeds on decks, balconies and podium level surfaces which are to be topped or tiled

Colour	Size	Code
Grey	15L	MULTITHST/15



Duroproof PU - Durotech

A high performance, fast cure, liquid applied, elastomeric polyurethane membrane that cures to form a seamless tough and flexible waterproof lining. Duroproof PU has a high viscosity to achieve a high build without slumping. It has excellent bond strength to most primed common building materials.

Applications

- Planter boxes
- Tanking
- Retaining walls
- Above and below grade structures
- Balconies and podium decks
- Between concrete slabs
- Suitable for non-exposed applications only

Colour	Size	Code
Black	18.9L	DUROPUBL/18.9



Duroproof NEP - Durotech

A low viscosity, high performance, single component, liquid applied, elastomeric (class 3) polyurethane membrane that cures rapidly to form a tough flexible waterproof lining. Duroproof NEP has excellent bond strength to most primed common building substrates and is suitable for both internal and external applications.

Applications

- Shower recesses and wet areas (floors and upturns)
- Reinforced concrete and fibrous cement sheeting floors in bathrooms and laundries
- Waterproofing beneath screeds on decks, balconies and podium level surfaces which are to be topped or tiled

Colour	Size	Code
Grey	15L	DURONEP/15



Dampfix PU - ASA

A low viscosity, high performance, single component, liquid applied, elastomeric (class 3) polyurethane membrane that cures rapidly to form a tough flexible waterproof lining. Dampfix PU has excellent bond strength to most primed common building substrates and is suitable for both internal and external applications.

Applications

- Shower recesses and wet areas (floors and upturns)
- Reinforced concrete and fibrous cement sheeting floors in bathrooms and laundries
- Waterproofing beneath screeds on decks, balconies and podium level surfaces which are to be topped or tiled

Colour	Size	Code
Light Grey	15L	DAMPFPU/15



Primeseal Bitum - Bostik

One-part bitumen modified (coal tar free), moisture curing, liquid polyurethane membrane. When cured it provides a tough highly elastomeric, impervious barrier to moisture.

Applications

- Below grade concrete and masonry walls and footings
- Concrete and masonry basement walls and footings
- Concrete and masonry retaining walls and footings
- Internal planter box walls and floors graded to drainage

Colour	Size	Code
Black	25kg	PRIMEBIT/25



Sikatite PU - Sika

Solvent based polyurethane membrane designed for below screed applications, balconies, planter boxes and podium areas.

Applications

- Shower recesses and wet areas (floors and upturns)
- Reinforced concrete and fibrous cement sheeting floors in bathrooms and laundries
- Waterproofing beneath screeds on decks, balconies and podium level surfaces which are to be topped or tiled
- Suitable for non-exposed applications only

Colour	Size	Code
Grey	15L	SIKAPU/15



Crystoflex - Duram

A flexible (class 2) UV resistant, two-part waterproofing membrane comprised from a cement base and selected polymers to create a tough and flexible waterproof seal.

Applications

- Retaining walls and planter boxes
- Water retaining structures such as concrete tanks, ponds, pools and fountains
- Under tile waterproofing on balconies, terraces, podiums and decks
- Wet areas - Class 2 membrane
- Suitable for contact with drinking water

Colour	Size	Code
Grey	30kg	CRYSTO/30



Idrosilex Pronto - Mapei

A one component, non-flexible, osmotic cementitious mortar suitable for waterproofing concrete structures.

Applications

- Waterproofing foundations, walls, cellars, basements, lift-rooms, swimming pools, canals and reservoirs
- Waterproofing applications subject to negative hydrostatic pressure

Colour	Size	Code
Grey	20kg	IDROSILEX/20



Mapelastc Smart - Mapei

A two-component UV-resistant, highly-flexible cementitious mortar suitable for waterproofing and concrete protection applications. Mapelastc Smart has a crack bridging capacity up to 2mm.

Applications

- Waterproofing internal & external under tile applications including swimming pools
- Waterproofing hydraulic channels, faces of dams and basins
- Flexible protection for concrete structures
- Protection of cementitious renders or concrete with cracks due to shrinkage

Colour	Size	Code
Grey	30kg	MAPSMART/30



Mapelastc Foundation - Mapei

A two component, UV resistant, flexible cementitious mortar suitable for waterproofing concrete surfaces subject to both positive and negative pressure.

Applications

- Concrete retaining walls
- Underground applications such as car parks, cellars, swimming pools, lift pits and more

Colour	Size	Code
Grey	32kg	MAPEFOUND/32



Sikalastic 1K - Sika

A one component, flexible, fibre-reinforced mortar, cement based waterproofing membrane. Suitable for positive and negative pressure and surfaces subject to flexural strain. Sikalastic 1K can be applied to damp surfaces.

Applications

- Waterproofing retaining walls and tanks
- Internal waterproofing of walls and floors in basements
- Protection of concrete surfaces

Colour	Size	Code
Grey	20kg	SIKA1K/20



Sikatite 2 Part - Sika

A two-component fast drying flexible, latex modified, cement based membrane.

Applications

- Applications subject to negative hydrostatic pressure
- Fully immersed applications- pools, ponds, spas etc
- Internal/external under-tile applications
- Suitable to be applied over green screeds

Colour	Size	Code
Grey	20L	SIKA2P/20

Torch Applied / Sheet Membranes



Duro Stick SP - Durotech

A self-adhesive bituminous elastomeric waterproofing sheet membrane. Made from a high performance polymer bitumen combined with non-tear polyester reinforcement.

Properties

- Excellent heat resistance
- Ideal for installation in restricted spaces
- Compatible with most building surfaces
- Can be torched with a cap sheet

Applications

- Timber and balcony decks
- Foundations
- Retaining walls
- Under cement screeds

Size	Type	Code
1mt x 15mt x 2mm	Roll	DUROSTICK



Duro Torch 3mm

A bituminous, plastomeric, torch-on membrane manufactured from a compound based on distilled bitumen modified with atactic polypropylene polymer (APP) and reinforced with a high strength polyester fabric.

Properties

- Excellent dimensional and mechanical stability
- Good flexibility at low temperatures
- Excellent heat resistance

Applications

- Civil
- Industrial
- Residential

Size	Type	Code
1mt x 10mt x 3mm	Roll	DUROTORCH/3



Duro Torch Mineral

A bituminous plastomeric torch-on waterproofing sheet membrane. Made from modified bitumen with atactic polypropylene polymer (APP), reinforced with high strength polyester fabric. The top is finished with a uniform layer of coloured slate chips.

Properties

- Good flexibility at low temperatures
- Excellent heat resistance
- UV resistant

Size	Type	Code
1mt x 10mt x 4.5mm	Roll	DUROMINERAL

Adheseal

Multi-Tack

Builders' Nails / Gap Filler / Joint Sealant

High Strength Construction Adhesive



Low VOC



Multi-Use



Internal & external use



Flexible



Water cleanup



Paintable



High initial grab



UV stable

Multi-Tack is a newly formulated, green star compliant, solvent free multi purpose construction adhesive, ideal for use as an adhesive, joint sealant or gap filler. It has excellent UV resistance and is green star compliant.

Features

- 3 products in 1 - adhesive, joint sealant, gap filler
- Suitable for interior and exterior applications
- Paintable
- High initial grab
- Does not become brittle
- Flexible
- Water clean up
- Excellent UV resistance
- Low VOC (complies with Green Star VOC)

Applications

- General purpose construction adhesive
- General purpose gap filling and joint sealing
- Flooring and wall systems
- Bonding timber, metal concrete and most common construction materials
- Cornice adhesive
- Bonding timber to studs and joists
- Installation of wall sheeting
- Bond polystyrene foam components



Adheseal
The Adhesive and Sealant Specialists

Adheseal Head Office
26 Wolverhampton Street
Stafford, Queensland 4053
Phone: (07) 3356 0000
sales@adheseal.com.au

Adheseal Sunshine Coast
2/18 Kessling Ave
Kunda Park, Queensland 4556
Phone: (07) 5477 0022
sc@adheseal.com.au

www.adheseal.com.au

Adheseal

Concrete Repair & Treatment

*flex***KRETE**

Permanent Concrete Repair Solution

Revolutionary fast-set concrete repair material with superior adhesion and flexibility.



Trafficable in 60 minutes

A high performance, rapid setting, permanent concrete repair system based on vinyl polymer resin. This system is capable of being trafficable in 60 minutes and curing time can be accelerated to as little as 30 minutes if desired. FlexKrete cures 3-times harder than concrete with outstanding adhesion properties and is a long-term solution for deep holes, feather-edged or overlay repairs. It has exceptional durability and tolerates extreme abuse without breaking apart or popping out.

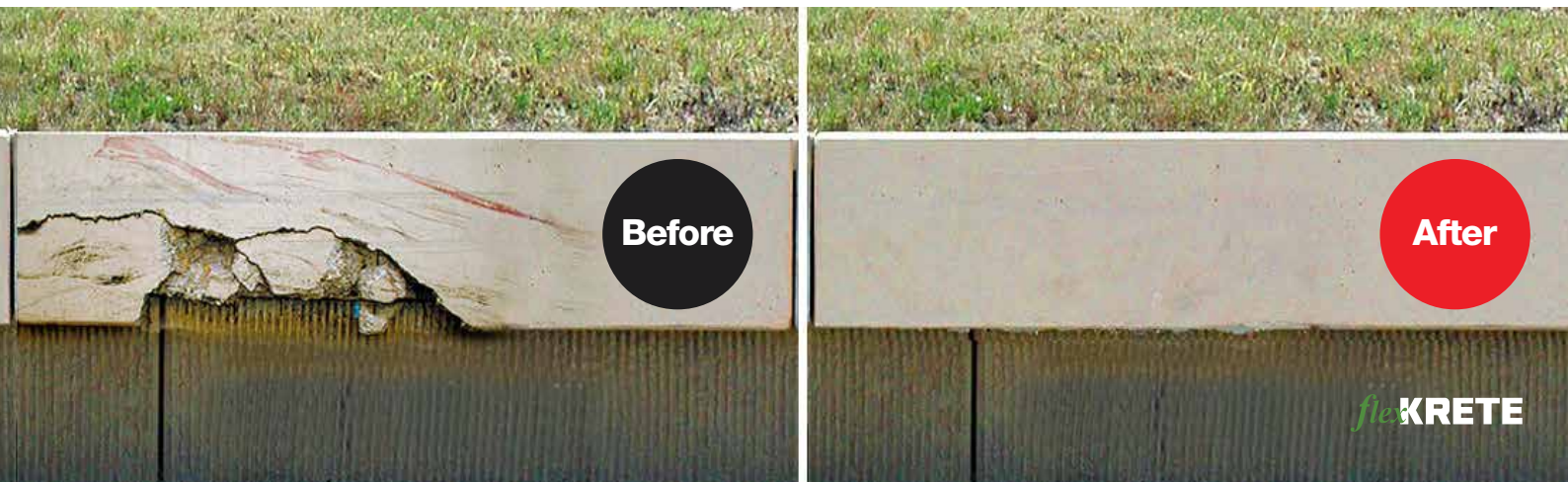

Applications



Crack Repairs



Patching



Vertical & Overhead

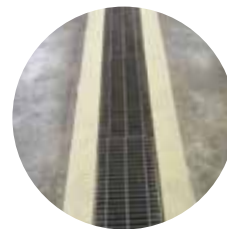

Nosing



Broadcast



Trafficable in 60 minutes
(Can be accelerated to 30 minutes)



Extremely Durable



Easy to Use



UV Resistant



Suitable for applications below freezing



Chemical Resistant



Structural Strength



Feather edge without breakage



Cured strength 80mpa

See more before/after images at www.adheseal.com.au

flex KRETE

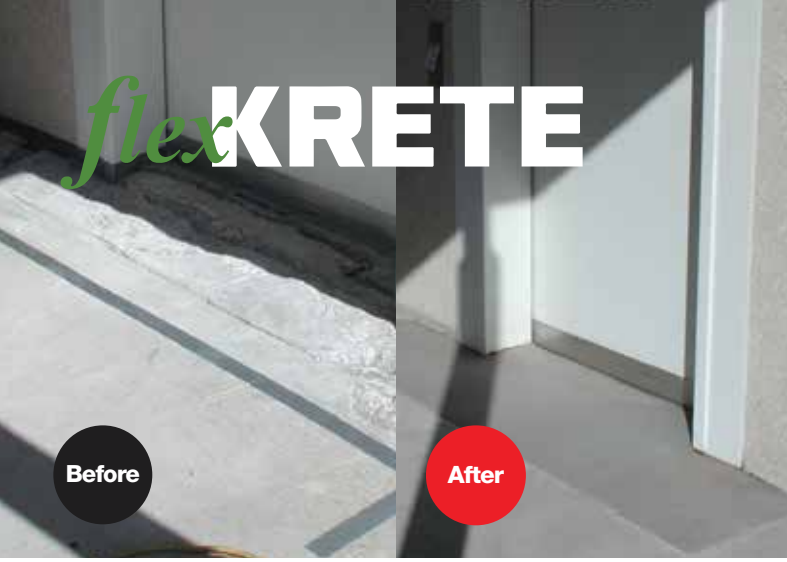



Flexkrete Trade Kit - Adheseal



A versatile concrete repair kit that is a permanent solution for many remedial applications. It will yield approximately 13 litres of mixed product for a horizontal application. This kit includes: Flexprime 500ml, Flexkrete 102 kit (4kg), measuring containers, mixing bucket and kiln dried sand.

Size	Code
Trade Kit	FKTK



FlexPrime - Adheseal



A two-part, modified polymer used as a bonding agent and vapour barrier for concrete and steel before the application of Flexkrete 102. This primer promotes adhesion to damp concrete and helps eliminate pinholes caused by outgassing. FlexPrime can be applied by brush, roller or spray. Coverage - approximately 8m² per litre.

Size	Code
500ml	FKP/500
2L	FKP/2
10L	FKP/10



Flexkrete 102 - Adheseal



A two-part vinyl polymer resin for concrete repairs suitable for most remedial applications. FlexKrete can achieve 60 minute cure time and cures 3 times harder than concrete. It is essential to use this product in conjunction with FlexPrime primer.

Size	Code
4kg	FK102/4
20kg	FK102/20



FlexTemp - Adheseal



An optional additive used to rapidly accelerate the cure speed of FlexKrete 102 resin in applications that require an extremely fast return to service and is also recommended for applications in cooler environments. Using FlexTemp as an accelerant, can achieve full cure in as little as 15 minutes. Adding FlexTemp will allow FlexKrete 102 to be applied in temperatures as low as -18°C.

Size	Code
150ml	FKT/150



FlexKrete Fumed Silica - Adheseal



A fine synthetic powder used as a thickening agent for Flexkrete 102 resin to make it suitable for vertical and overhead Flexkrete applications.

Overhead Applications

- FlexKrete 102 Resin x 1 part
- Fumed Silica x 2 parts
- Fine Kiln Dried Sand x 1.5 parts

Vertical Applications

- FlexKrete 102 Resin x 1 part
- Fumed Silica x 1 part
- Fine Kiln Dried Sand x 2 parts

Size	Code
250g	FKFUMED/250
1kg	FKFUMED/1
10kg	FKFUMED/10

1

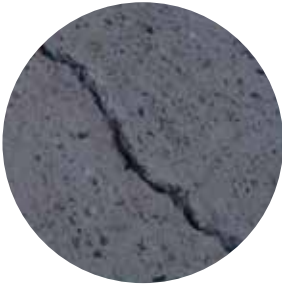

STEP 1
Prepare

V out the crack to a minimum 10mm wide with a V-segment crack chasing wheel.

2



STEP 2
Clean surface

Remove dirt, debris, paint and contaminants to produce a clean, dry solid base. Mechanically clean area as needed. If required, mechanically key the application area. Vacuum or blow clean to remove excess dust.

! Applying gaffer tape to borders of application area will ensure straight edges and a neat finish.

3



STEP 3
Prime

Mix FlexPRIME parts A & B in equal amounts. Apply a very thin coat to prepped area using a brush, roller or sprayer (avoid puddles/ridges). Optional - Thin with up to 10% acetone for easy application and penetration. Allow FlexPRIME to become very tacky before applying FlexKRETE.

4



STEP 4
Mix FlexKRETE 102 Resin (Part A)

Open pail and power-mix for 60 seconds with power drill to disperse material (before pouring required quantity).

5



STEP 5
Measure FlexKRETE 102 Resin (Part B)

Measure and pour required quantity into clean mixing pail.

6



STEP 6
Catalyse

Add FlexKRETE 102 CATALYST (Part B) to FlexKrete Resin (Part A) and power-mix (at low speed - 300rpm) for 30 seconds.

7



STEP 7
Apply Catalysed FlexKRETE

Apply catalysed Flexkrete 102 (in liquid form) into the application area to half fill the crack.

8



STEP 8
Apply sand

Apply (dry) fine kiln dried sand into the application area to over fill the void (add sand to refusal).

9



STEP 9
Grind

Once cured, grind the excess cured product to a smooth finish to complete application.

! Optional - Apply a FlexKrete broadcast application over treated area.

1



STEP 1
Clean surface

Remove dirt, debris, paint and contaminants to produce a clean, dry solid base. Mechanically clean area as needed. If required, mechanically key the application area. Vacuum or blow clean to remove excess dust.

! Applying gaffer tape to boarders of application area will ensure straight edges and a neat finish.

2



STEP 2
Prime

Mix FlexPRIME parts A & B in equal amounts. Apply a very thin coat to prepped area using a brush, roller or sprayer (avoid puddles/ridges). Optional - Thin with up to 10% acetone for easy application and penetration. Allow FlexPrime to become very tacky before applying FlexKRETE.

3



STEP 3
Mix FlexKRETE 102 Resin (Part A)

Open pail and power-mix for 60 seconds with power drill to disperse material (before pouring required quantity).

4



STEP 4
Measure FlexKRETE 102 Resin (Part A)

Measure and pour required quantity into clean mixing pail.

! 1 litre of FlexKRETE resin will yield approximately 3 to 3.5 litres of mixed product.

5



STEP 5
Catalyse

Add FlexKRETE 102 CATALYST (Part B) to FlexKrete Resin (Part A) and power-mix (at low speed - 300rpm) for 30 seconds.

6



STEP 6
Measure and add aggregate

Add 3 to 4 parts kiln dried sand into a mixing pail containing catalyzed FlexKRETE, then power-mix (at low speed) until well blended.

7



STEP 7
Apply material

Pour into void, and then fill flush, pushing firmly into voids. Trowel smooth using long, smooth strokes. Remove gaffer tape (before FlexKrete is cured). Sprinkle sand onto uncured FlexKRETE to reduce tack.

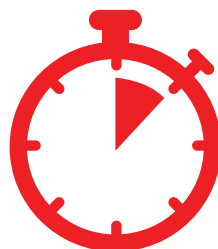

**Trafficable in
60 minutes**



**Cured strength
80mpa**

1



STEP 1
Clean surface

Remove dirt, debris, paint and contaminants to produce a clean, dry solid base. Mechanically clean area as needed. If required, mechanically key the application area. Vacuum or blow clean to remove excess dust.

! Applying gaffer tape to borders of application area will ensure straight edges and a neat finish.

2



STEP 2
Prime

Mix FlexPRIME parts A & B in equal amounts. Apply a very thin coat to prepped area using a brush, roller or sprayer (avoid puddles/ridges). Optional - Thin with up to 10% acetone for easy application and penetration. Allow FlexPrime to become very tacky before applying FlexKRETE.

3



STEP 3
Mix FlexKRETE 102 Resin (Part A)

Open pail and power-mix for 60 seconds with power drill to disperse material (before pouring required quantity).

4



STEP 4
Measure FlexKRETE 102 Resin (Part A)

Measure and pour required quantity into clean mixing pail.

! 1 litre of FlexKRETE resin will yield approximately 2 litres of mixed product.

5



STEP 5
Catalyse

Add FlexKRETE 102 CATALYST (Part B) to FlexKrete Resin (Part A) and power-mix (at low speed - 300rpm) for 30 seconds.

6A



STEP 6A - VERTICAL APPLICATIONS
Measure & add aggregate and fumed silica

Mix 2 parts kiln dried sand and 2-3 parts FlexKrete fumed silica. 3 parts FlexKrete Fumed Silica produces a stiff, dough-like material that can be hand-placed and trowelled smooth. 2 parts fumed silica and 2 parts sand produces a less-stiff material and is recommended as a good starting point to evaluate ratios required.

6B



STEP 6B - OVERHEAD APPLICATIONS
Measure & add aggregate and fumed silica

Mix 1.5 parts kiln dried sand and 2 to 3 parts fumed silica. If material is too heavy, decrease the amount of sand (to a minimum of 1 part).

7



STEP 7
Apply material

Trowel into void, and then fill flush, pushing firmly into voids. Trowel smooth using long, smooth strokes. Remove gaffer tape.

! Remove gaffer tape from borders (if applied) before product has cured.



**Trafficable in
60 minutes**

1



STEP 1 Clean surface

Remove dirt, debris, paint and contaminants to produce a clean, dry solid base. Mechanically clean area as needed. If required, mechanically key the application area. Vacuum or blow clean to remove excess dust.

! Applying gaffer tape to boarders of application area will ensure straight edges and a neat finish.

2



STEP 2 Prime

Mix FlexPRIME parts A & B in equal amounts. Apply a very thin coat to prepped area using a brush, roller or sprayer (avoid puddles/ridges). Optional - Thin with up to 10% acetone for easy application and penetration. Allow FlexPrime to become very tacky before applying FlexKRETE.

3



STEP 3 Mix FlexKRETE 102 Resin (Part A)

Open pail and power-mix for 60 seconds with power drill to disperse material (before pouring required quantity).

4



STEP 4 Measure FlexKRETE 102 Resin (Part A)

Measure and pour required quantity into clean mixing pail.

! 1 litre of FlexKRETE resin will yield approximately 1.5 - 2 litres of mixed product.

5



STEP 5 Catalyse

Add FlexKRETE 102 CATALYST (Part B) to FlexKrete Resin (Part A) and power-mix (at low speed - 300rpm) for 30 seconds.

6



STEP 6 Measure and add aggregate

Add 1.5 - 2 parts kiln dried sand into mixing pail containing catalysed FlexKRETE, then power-mix until well blended.

7



STEP 7 Apply material

Pour a ribbon of slurry-mix onto repair area using a notched squeegee or gauge rake. Apply material to desired depth. Immediately broadcast with aggregate and allow to cure.

! For self-levelling: Leave alone, or for a fine slurry-broadcast repair, immediately broadcast with aggregate.



**Trafficable in
60 minutes**



**Cured strength
80mpa**

1

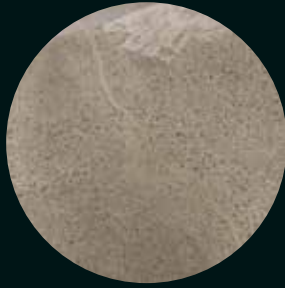

STEP 1
Clean surface

Remove dirt, debris, paint and contaminants to produce a clean, dry solid base. Mechanically clean area as needed. If required, mechanically key the application area. Vacuum or blow clean to remove excess dust.

! Applying gaffer tape to borders of application area will ensure straight edges and a neat finish.

2



STEP 2
Prime

Mix FlexPRIME parts A & B in equal amounts. Apply a very thin coat to prepped area using a brush, roller or sprayer (avoid puddles/ridges). Optional - Thin with up to 10% acetone for easy application and penetration. Allow FlexPrime to become very tacky before applying FlexKRETE.

3



STEP 3
Mix FlexKRETE 102 Resin (Part A)

Open pail and power-mix for 60 seconds with power drill to disperse material (before pouring required quantity).

4



STEP 4
Measure FlexKRETE 102 Resin (Part A)

Measure and pour required quantity into clean mixing pail.

! 1 litre of FlexKRETE resin will yield approximately 2 - 4m² of mixed product.

5



STEP 5
Catalyse

Add FlexKRETE 102 CATALYST (Part B) to FlexKrete Resin (Part A) and power-mix (at low speed - 300rpm) for 30 seconds.

6



STEP 6
Apply Catalysed FlexKRETE

Pour FlexKrete material onto repair area. Using a roller or squeegee, apply the material at 2 - 4m² per litre depending on substrate condition and the size of the aggregate being used.

7



STEP 7
Apply broadcast

Immediately broadcast to refusal with aggregate then allow to cure. Sweep excess aggregate from surface & open to traffic.

! A final topcoat may be applied, such as a good quality Polyurethane or Polyaspartic Sealer. FlexKote 1PU-C or FlexKote 2AS-C Sealers are recommended.



**Trafficable in
60 minutes**



**Cured strength
80mpa**



Everbond Acrylic Bonding Agent - Adheseal

Acrylic Bonding Agent is used as a bonding agent for mortar, renderings and floor screeds producing waterproof and damp-proof screeds, renders and slurries. It also can be used to create a highly wear resistant topping on stair treads, drains, sewage treatment plants and more.

Size	Code
5L	ACRYBOND/5
20L	ACRYBOND/20



Everbond Plastabond - Adheseal

Plastabond is a bonding agent/additive for:

- Mortar, renderings and floor screeds
- Improving the properties of screeds, renders and slurries
- Patching and repair mortar
- Improving adhesion of renderings to insulation boards and materials
- Producing mortars resistant to chemical attack

Size	Code
5L	PLASTAB/5
20L	PLASTAB/20

Efflorescence Remover



EP Efflorescence Remover - Enviropacific

A liquid applied treatment that removes efflorescence from bricks, blocks and all masonry materials. It is non-toxic and biodegradable and is suitable for commercial and residential applications.

Size	Code
5L	EPEFFLOR/5
20L	EPEFFLOR/20

Plugging



Lamposilex Waterstop - Mapei

An ultra-fast setting hydraulic binder to instantly stop water leaks.

Uses

- Plugging water under pressure, in basements, tunnels and subways
- For sealing watertight rigid joints in hydraulic concrete structures, sewers, tanks and canals

Size	Code
5kg Drum	LAMPOSIL/5





Aquastop Waterstop - Pasco

A flexible hydrophilic polymer rubber used to stop water infiltration through vertical and horizontal non-moving construction joints, irregular surfaces and around penetrations through concrete. When in contact with water, Aquastop swells to form an impermeable barrier to prevent water migration. It is suitable for applications such as underground structures, tunnels, box culverts, pits, retaining walls, manholes, basements and precast panels.

Size	Type	Code
19mm x 25mm x 5mt	Roll	AQUASTOP19X25/5



Idrostop - Mapei

A hydrophilic expandable rubber section for creating watertight construction joints in civil, industrial and hydraulic construction applications.

Product	Size	Code
Idrostop 10	20mm x 10mm x 10mt	IDROSTOP/10
Idrostop 15	20mm x 15mm x 7mt	IDROSTOP/15
Idrostop 25	20mm x 25mm x 5mt	IDROSTOP/25



Idrostop Mastic - Mapei

Single-component adhesive for the installation of Idrostop. Idrostop Mastic is a ready to use solvent-free single-component adhesive with a base of MS polymers. On extrusion, it is a thixotropic paste suitable for horizontal and vertical applications.

Product	Size	Code
Idrostop Mastic	300ml Cartridge	IDROSTOP/MAS

Epoxy Grouts & Repair & Injection Products



Megapoxy P1

Gap Filling / Structural Epoxy Paste Adhesive (2 component).

Features

- Ideal for concrete structural bonding, filling and repair applications
- Commonly used in pipeline & civil construction
- Suitable for potable water applications
- 60 minute work time / 24 hour cure time

Colour	Size	Code
Grey	1L Kit	MPP1/1
Grey	4L Kit	MPP1/4
Grey	20L Kit	MPP1/20



Megapoxy PM (Paste medium work time)

Gap Filling / Structural Epoxy Paste Adhesive (2 component).

Features

- Commonly used for structural bonding, gap filling and repairs on concrete, marble & granite and other construction materials
- Tensile and compressive strength superior to concrete
- Very good chemical resistance
- 45 minute work time / 24 hour cure time

Colour	Size	Code
Natural (white)	1L Kit	MPPMWH/1
Grey	4L Kit	MPPMGR/4
Natural (white)	4L Kit	MPPMWH/4
Grey	20L Kit	MPPMGR/20
Natural (white)	20L Kit	MPPMWH/20



Megapoxy PF (Paste fast work time)

Rapid Set Gap Filling / Structural Epoxy Adhesive (2 component).

Features

- Commonly used for structural bonding, gap filling and repairs on concrete, marble & granite fixing and other construction materials
- Suitable for immediate on the spot emergency repairs to tanks, pipes, machinery & concrete structures
- Tensile and compressive strength superior to concrete
- Very good chemical resistance
- 5 minute work time / 60 minute cure time

Colour	Size	Code
Natural (white)	1L Kit	MPPFWH/1
Grey	4L Kit	MPPFGR/4
Natural (white)	4L Kit	MPPFWH/4
Grey	20L Kit	MPPFGR/20
Natural (white)	20L Kit	MPPFWH/20



Megapoxy H

Low Viscosity Hydrophilic Epoxy Resin Liquid (2 component).

Features

- Suitable for repair of cracked concrete by low pressure injection impregnation of porous substrates such as masonry and timber
- Vapour Barrier
- Wet to dry binding agent to eliminate cold joints
- Suitable for use in damp conditions

Colour	Size	Code
Natural (Clear)	4L Kit	MPH/4
Grey - N35	4L Kit	MPHGR/4
Natural (Clear)	20L Kit	MPH/20
Grey - N35	20L Kit	MPHGR/20



Megapoxy HX

Extra Low Viscosity Hydrophilic Epoxy Resin Liquid (2 component).

Features

- Suitable for repair of cracked concrete by gravity penetration or low pressure injection impregnation of porous substrates such as masonry and timber
- Suitable for use in damp conditions

Colour	Size	Code
Natural (Extra Clear)	4L Kit	MPHX/4
Natural (Extra Clear)	20L Kit	MPHX/20



Megapoxy 57

Heavy Duty Epoxy Grout - with extended work time (2 component).

Features

- Epoxy grout suitable for grouting machinery, locking bearings, setting anchor bolts, chocking of machinery, rail track grouting and bridge bearing pads

Colour	Size	Code
Green	9.4kg Kit	MP57/9



Megapoxy HICB

High Impact Crusher Backing (for fast return to service).

Features

- Epoxy grout for backing crusher parts, grouting machinery, locking bearings, setting anchor bolts and chocking of machinery
- Outstanding compressive strength properties with very low shrinkage

Colour	Size	Code
Blue	10kg Kit	MPHICB/10

Cementitious Grouts & Repair Products



Mapegrout T40 - Mapei

A medium strength fibre-reinforced, thixotropic mortar for repairing concrete. Suitable for horizontal and vertical applications.

Size	Code
25kg	MAPEGROUTT40



Mapegrout T60 - Mapei

A sulphate-resistant fibre-reinforced, thixotropic mortar for the repair of degraded concrete structures subject to sulphate attack.

Size	Code
25kg	MAPEGROUTT60



Mountain Grout Gel Foam - Green Mountain International

A single component, low viscosity hydrophilic polyurethane formulation with high elongation properties for sealing leaking cracks or joints in concrete structures with continuous moisture exposure. Expands up to 25 times initial volume.

Typical Applications

- Water related facilities
- Waste treatment plants
- Storm water systems
- Underground vaults
- Concrete dams
- Tunnels
- Elevator Pits

Size	Code
4L	INJGELERA/4



Mountain Grout Flexible - Green Mountain International

A single component, low viscosity hydrophobic polyurethane formulation. It is typically used to repair cracks or failed joints in concrete structures. For some applications, it is recommended to use Mountain Grout Accelerator in conjunction with Mountain Grout Flexible. This will speed the curing process. Refer to TDS for detailed information.

Typical Applications

- Water related facilities
- Concrete dams
- Waste treatment plants
- Tunnels
- Storm water systems
- Earthen dams
- Underground vaults
- Elevator pits
- Parking garages

Product	Size	Code
Mountain Grout Flexible	4L	INJFLEXERA/4

Adheseal

Hybrid MS Polymer Range

Automotive / Construction / Industrial / Marine

Low VOC

Solvent Free

Isocyanate Free

Hi Flex Construction
Joint Sealant

Hi Flex 60LS
Structural Adhesive / Sealant

Hi Power
Extreme Structural Adhesive



Crack Injection Balloon - Resimax

Resimax crack injection balloons are designed to be used with Megapoxy H and HX epoxy resins and some polyurethane injectable products for permanent structural repair of cracks in concrete structures.

Balloon Concept

- Provides a visual aid to the process of filling the crack. It stays inflated when the crack is full.

Clear Base

- Allows accurate placement of the balloon. Allows you to see the crack and also lets you see the resin when it rises to the balloon. The base is designed to prevent adhesive blocking the aperture during placement.

Latex Hose

- Balloons out to 20mm (to keep the injection system pressurised).

Tap connection

- Ensures secure closure of the balloon after inflation and allows leakage free connection to a injection gun. Also allows taps further along the crack to be left open if desired.

Product	Code
Crack Injection Balloon	INJBALLOON



Injection Packer Brass

Brass injection packer with grease nipple for application and a non-return valve. When the resin has set, the top of the packer unscrews. This enables the base to be left in place leaving a small recess which can easily be filled with epoxy or PU injection foam.

Size	Code
6mm x 46mm	INJPACKT/6
8mm x 50mm	INJPACKT/8



Injection Packer Hammer In

Hammer in packer designed for wider cracks.

Size	Code
-	INJPACKHAMT



Injection Guns - Resimax

Injection gun compatible for crack injection applications.

Size	Code
-	INJGUN/RES

1

STEP 1

Preparation

The application surface to be treated should be cleared of all debris and attachments to allow free and clear access to the work, and also open access for monitoring of grout travel.

2

STEP 2

Drill Holes

Holes should be drilled at an approximate 45 degree angle, offset to intersect the joint/crack at the approximate mid-depth or to a maximum of 450mm. In thin concrete sections holes may be drilled directly into the joint/crack.

3

STEP 3

Space Holes

Holes shall be placed at appropriate intervals typically 300mm apart to ensure full infiltration of the joint/crack with the product. In narrow (hairline) or highly erratic cracks, holes will be closer together. In wide cracks they may be farther apart. Visually monitor grout flow from outside of crack.

4

STEP 4

Pack

Insert chosen packer devices.

5

STEP 5

Pump

Connect application pump and pump product from packer to packer, with multiple passes on each hole until either stall pressure is achieved or raw grout flow is observed from the crack/joint. Start at lowest point and work upwards

6

STEP 6

Clean

Clean excess product from the application area.



Use as a general guide only. Refer to TDS for specific requirements.

1



STEP 1

Preparation

The surfaces of floors / walls are to be treated and should be clean and clear of all debris.

2



STEP 2

Adhere injection balloons

Use Megapoxy PM or PF to adhere the injection balloons in place and seal surface of cracks over the cracks ready for injection.

Megapoxy PM - Epoxy Paste - 45 minute work time / 24 hour cure time

Megapoxy PF - Epoxy Paste - 5 minute work time / 1 hour cure time

3



STEP 3

Inject Megapoxy H or HX

Use injection gun to inject Megapoxy H or HX through the injection balloons into cracks. The balloon will remain inflated when the cracks and voids are full.

Megapoxy H - Low viscosity hydrophilic epoxy resin used for permanent structural crack repairs.

Megapoxy HX - Very low viscosity hydrophilic epoxy resin used for permanent structural crack repairs.

4



STEP 4

Remove

Once the epoxy is cured, mechanically remove the Megapoxy PM or PF and Injection Balloons.



Use as a general guide only. Refer to TDS for specific requirements.

Adheseal

100 Uses

Superstrip Degreaser

Commercial Grade Concentrated Degreaser



Workshops



Automotive



Marine



Construction



DIY



Agricultural



Transport



Manufacturing

A hi-performing concentrated degreaser that cuts through the heavy contamination of oil, grease, carbon and more. 100 Uses is a heavy duty concentrate and is designed to be diluted to suit the application.

Suitable for:

- Workshops
- Automotive
- Boats/marine
- Construction sites
- Manufacturing
- Agricultural/farms
- Transport industry
- DIY



Adheseal
The Adhesive and Sealant Specialists

Adheseal Head Office
26 Wolverhampton Street
Stafford, Queensland 4053
Phone: (07) 3356 0000
sales@adheseal.com.au

Adheseal Sunshine Coast
2/18 Kessling Ave
Kunda Park, Queensland 4556
Phone: (07) 5477 0022
sc@adheseal.com.au

Adheseal

Flooring, Roofing and Decking



UC Leveller - Mapei

A fast hardening levelling / smoothing compound for interior applications suitable for depths of 3mm to 70mm. UC Leveller can be used where resistance to heavy loads and traffic is needed along with an especially smooth surface.

Colour	Size	Code
Grey	20kg	UCLEVELLER



Ultraplan - Mapei

An ultra-fast levelling / smoothing compound for interior applications suitable for depths of 1mm to 15mm. Ultraplan can be used where resistance to heavy loads and traffic is needed along with an especially smooth surface.

Colour	Size	Code
Grey	20kg	ULTRAPLAN

Liquid Flashing Repair Product



Roofers Flash n Patch Liquid Flashing - Adheseal

A highly elastic waterborne hybrid acrylic sealant for applications such as sealing around roof penetrations, seams, inside guttering, damaged roof tiles, punctured roof membrane and around dektites. It has an exceptional resistance to weathering and possesses excellent adhesion to most building materials whilst still maintaining its superb elasticity through both hot and cold climates. Flash n Patch has outstanding adhesion to many common materials including colorbond, zincalume, aluminium, polycarbonate, brick and blockwork, timber, steel and pvc.

Features:

- Excellent adhesion
- UV stable
- Outstanding elasticity
- Water clean up
- Non staining
- Non toxic
- Non hazardous
- Paintable

Colour	Size	Code
Grey	10L	FLASHPATCH/10

Protective and Decorative Coatings

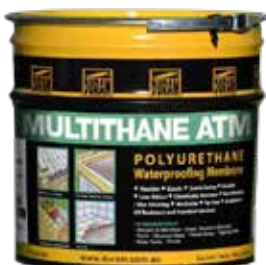

Multithane ATC - Duram

A single pack, aliphatic polyurethane waterproofing top coat which has been formulated as a complimentary top coat for Multithane UV. ATC provides greater UV protection and forms a tough, flexible, seamless, highly UV stable, waterproof coating.

Colour	Size	Code
Grey	15L	MULTITHATC/15



Everflex WPUV - Adheseal

A high performance UV stable waterborne polyurethane / latex waterproofing membrane suitable for internal and external applications. It can be topped, tiled or left exposed and is capable of accommodating expected structural movement.

Applications:

- Exposed concrete and metal roofs
- Balconies, patios and decks to be topped or tiled
- Showers and plant rooms

Colour	Size	Code
Grey	15L	WPUV/15



Virotoff - Duram

A water based single pack, liquid applied, urethane / polymer, decorative, anti-slip protective coating. Virotoff provides a UV resistant, tough, durable, semi-flexible trafficable coating with an attractive textured finish. It is suitable for foot and vehicular traffic and is available in a range of colours.

Slip Resistance Rating: Tested to AS/NZ 4586:2004 BPN up to 58.

Appendix A - (Wet Pendulum): Class V After 5000 cycles: BPN up to 44 Class X

Applications:

- Decks, balconies, patios, garages, steps, entertaining and pool surrounds
- Playgrounds, walkways, public toilets and change rooms
- Commercial kitchens and bar areas
- Factory and warehouse floors

Available Colours:

- Black
- Light Grey
- Dark Grey
- Charcoal
- Mossvale
- Clay Pot
- Raw Cotton
- Balsa Stone
- Safety Yellow
- Jarrah
- Heartwood

Colour	Size	Code
Light Grey	4L	VIROTUFFLG/4
Light Grey	15L	VIROTUFFLG/15
Dark Grey	4L	VIROTUFFDG/4
Dark Grey	15L	VIROTUFFDG/15
Safety Yellow	4L	VIROTUFFSY/4
Safety Yellow	15L	VIROTUFFSY/15



Traffic Pave - Aftex

A water-based, slip-resistant UV stable coating with excellent performance against wear and weathering, providing a rejuvenated fresh and safe surface coating that is suitable for internal and external use. Traffic Pave has excellent hot tyre resistance and forms a hardwearing finish.

Available Colours:

- Tan
- Terracotta
- Light Grey
- Slate Grey
- Black
- Daffodil
- Snow
- Emerald
- Sea

Colour	Size	Code
Light Grey	14L	TRAFFPAVELG/14
Slate Grey	14L	TRAFFPAVESG/14



Megapoxy H - Primer

A low viscosity epoxy sealer that is commonly used as a primer coat for Megapoxy protective & decorative floor coatings (including paint flake flooring systems).

Colour	Size	Code
Clear	4L	MPH/4
Clear	20L	MPH/20



Megapoxy 132

Megapoxy 132 is a two-component solvent-less 100% solids epoxy resin. It creates a heavy duty, protective, chemical resistant epoxy coating suitable for decorative floor and wall cladding. Using durable, non - fading pigments will provide floor toppings and wall coatings with pleasing and serviceable appearance and strength. Suitable for garage floors, warehouse or factory floors and can also be used to create a trowelable mortar for screeding floors.

Colour	Size	Code
Clear	15L Kit	MP132CL/15
Clear	30L Kit	MP132CL/30
Grey - N35	15L Kit	MP132GR/15
Grey - N35	30L Kit	MP132GR/30



Megapoxy MC

A two-component epoxy resin that creates a heavy duty, protective and decorative coating for concrete, steel, timber, masonry and more. It has a high resistance to abrasion, impact and a wide range of chemicals. Megapoxy MC can be applied by airless spray equipment, roller or brush and has a long working time (2 hours). For applications requiring fast cure properties Megapoxy MC2 is also available.

Features/Applications:

- Floor & wall coating (decorative & protective)
- Base coat for a decorative paint flake floor coating system
- Provides a hygienic, dust free surface
- Suitable for use in storage tanks that hold chemicals such as foodstuffs and fuel
- Suitable for use in pools
- Resistant to hydrogen sulphide that may be present in pipes and plants used for treatment of sewage

Available Colours*



White	5kg Kit	MPMCWH/5
Grey	5kg Kit	MPMCGR/5
Koala Grey	5kg Kit	MPMCKOGR/5
Dark Grey	5kg Kit	MPMCDKGR/5
Pacific Blue	5kg Kit	MPMCPB/5
Safety Yellow	5kg Kit	MPMCYELL/5
Black	5kg Kit	MPMCBLK/5

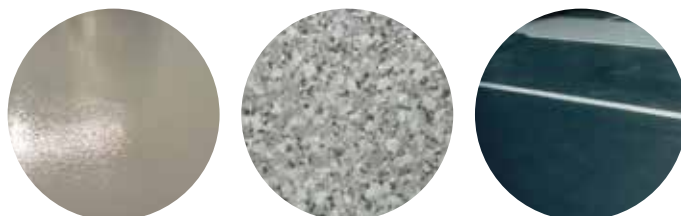

*Colours are not exact. Colours shown are a representation only. Please refer to the actual product sample.

Adheseal

FlexFlake

Step by step installation guide



STEP 1 Prepare

Diamond grind or acid etch the concrete substrate to provide a sufficient key and remove any impurities in the slab such as residues and paint oil grease etc. Previous coatings should be removed and substrate issues such as rising damp problems should be treated before proceeding.



STEP 2 Repair

Repair cracks and any imperfections in the substrate.



STEP 3 Clean

Ensure that the floor surface is clear, dust-free.



STEP 4 Primer

Apply primer coat and allow to fully cure.



STEP 5 Base Coat

Apply selected coloured base coat



STEP 6 Broadcast Flakes

Evenly broadcast FlexFlake paint flakes ensuring the entire floor has dry flake applied. Then allow coloured base coat to fully cure.



STEP 7 Remove Loose Flakes

Use a garden blower or vacuum to remove excess (un-bonded) flake then use a large scraper to remove any loose or sharp flake.



STEP 8 Clean

Again, use a garden blower or vacuum to remove excess (un-bonded) flake.



STEP 9 Seal

Apply a coat of sealer with FlexKote 1PU-C or FlexKote 2AS-C (ensuring there is no pooling). Apply more coats if required.



FlexPrime - Adheseal

A two-part, modified polymer used as a bonding agent and vapour barrier for concrete, timber and steel before the application of Flexkrete 102. This primer promotes adhesion to damp concrete, helps eliminate pinholes caused by outgassing. FlexPrime can be applied by brush, roller or spray. Approximately 8m² per litre coverage.

Size	Code
500ml	FKP/500
2L	FKP/2
10L	FKP/10



Flexkrete 102 - Adheseal

A rapid curing two-part vinyl polymer resin that is used as a base coat for a paint flake floor coating system and also for concrete repair applications. FlexKrete 102 can achieve a 60 minute cure time and cures 3 times harder than concrete. It is essential to use this product in conjunction with FlexPrime primer.

Applications:

- Base coat for paint flake flooring systems
- Base coat for surface reinstatement (broadcast)
- Remedial concrete repairs

Colour	Size	Code
Grey	4kg	FK102GR/4
Grey	20kg	FK102GR/20



FlexTemp - Adheseal

An optional additive used to rapidly accelerate the cure speed of FlexKrete 102 resin in applications that require extremely fast return to service and is also recommended for applications in cooler environments. Using FlexTemp as an accelerant, can achieve full cure in as little as 15 minutes. Adding FlexTemp will allow FlexKrete 102 to be applied in temperatures as low as -18°C.

Size	Code
150ml	FKT/150



FlexKote 1PU - Adheseal

A high performance, single component, UV stabilised, clear, protective and seamless decorative polyurethane floor finish. This coating is a durable, non-yellowing sealer for concrete, masonry, FlexKrete and flake flooring applications.

Features:

- Extremely tough & durable
- Non-yellowing
- Stain resistant
- Wear resistant
- Tyre stain resistant
- Chemical resistant

Colour	Size	Code
Clear / High Gloss	10L	FKOTE1PUCG/10
Clear / High Gloss	20L	FKOTE1PUCG/20



FlexKote 2AS - Adheseal

A rapid drying high performance two-component polyaspartic floor coating. This non-yellowing formula is durable, abrasion resistant and provides a high gloss clear coating suitable for external and internal applications. FlexKote 2AS-C is commonly used when a rapid return to service is required or in low temperature cure environments such as cool rooms.

Features:

- Extremely tough & durable
- Fast return to service
- Low odour & non flammable
- Tyre stain resistant
- Excellent scratch resistance
- Non-yellowing
- Excellent chemical stain resistance

Applications:

- Clear or pigmented seamless floor coating for concrete
- Drive ways, walk ways, factory & shop floors

Colour	Size	Code
Clear / High Gloss	20L	FKOTE2ASCG/20



FlexFlake - Adheseal

Paint flakes that are one part of a multi-part epoxy or FlexKrete decorative flooring system that is widely used in commercial and domestic applications. There are a wide variety of single and blended Flake colours available.

Example Colours



Black Marble XL



Oyster

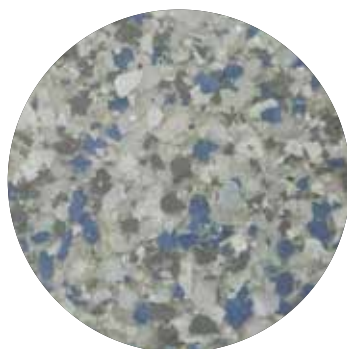

Glacier

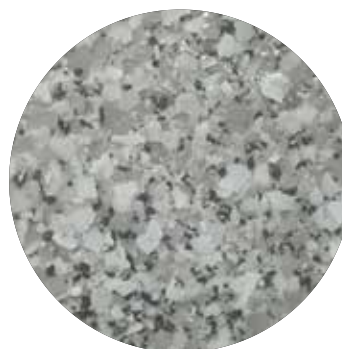

Moonlite

Please contact Adheseal to view the full colour range available.

*Colours are not exact. Colours shown are a representation only. Please refer to the actual product sample.

P E D E S T A L

Buzon



THE ORIGINAL AND AWARD WINNING SCREWJACK PEDESTAL



**Create Raised Timber & Paved Floors On Balconies,
Podiums & Roof Tops**

PASCO

www.buzon.com.au
www.buzon-world.com





Buzon Height Adjustable Pedestal



The award-winning Buzon Pedestal appeals to architects and builders when it comes to the design and construction of raised floors.

It can be used with pavers, timber decking and steel grating to create raised floors on balconies, terraces, green roofs, temporary floors and water features. Capable of accommodating heights from 17mm-1070mm, it can conceal services and offer easy access for maintenance of waterproof membranes.

The Buzon pedestal incorporates a patented slope-correcting device, which compensates for a substrate fall of 0-5%, to provide a perfectly level floor finish. The interchangeable spacer tabs allow for 2mm, 3mm, 4.5mm, 6mm, 8mm and 10mm gaps between pavers, providing positive drainage and making uneven paving lines a thing of the past.

Designed, manufactured and tested in Belgium, the Buzon pedestal is capable of supporting up to 1,000kg. Used on projects all over the world, the applications of the Buzon pedestal are endless.

DPH Series Pedestal Sizing Chart - Adjustable from 17mm to 1070mm

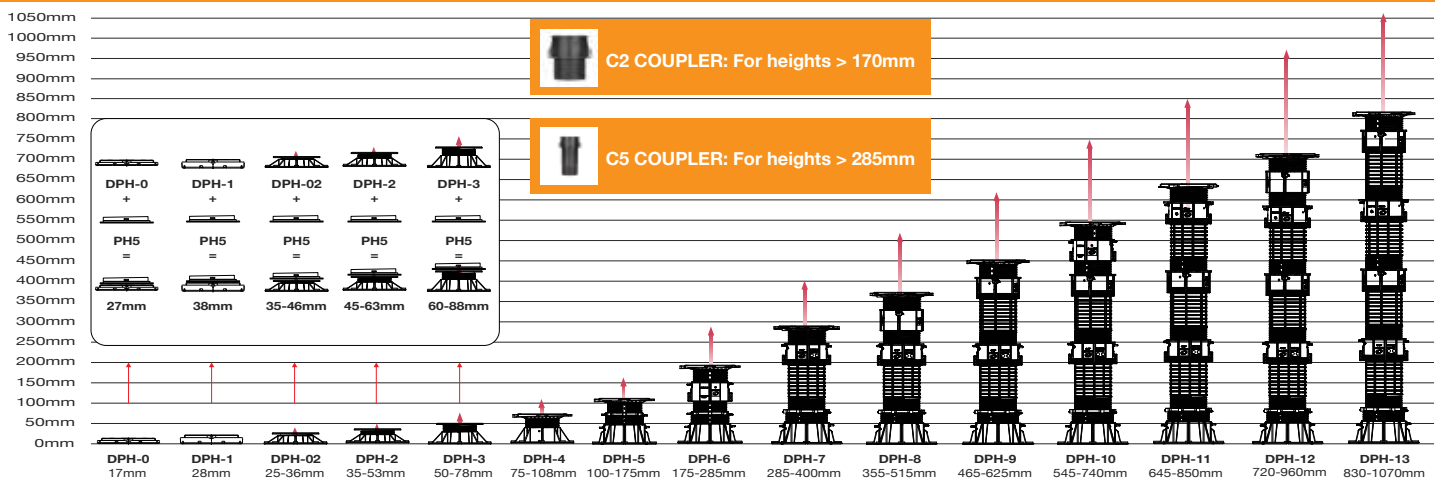

Spacer Tabs

The head can be fitted with spacer tabs, to give the desired opening between pavers for water drainage and ventilation.



Available with tab widths of 2, 4.5, 6, 8 and 10mm

Shims

Made of 1 and 2 mm Reinforced EPDM (Shore 50), for use with marble, granite and stone pavers to act as:

- Anti slip
 - Shock Absorber
- Also compensates for the difference in thickness of the pavers used during the installation



PH5 Slope Corrector

Manufactured from recycled polypropylene, the PH5 slope corrector can compensate for a horizontal slope, from 0 to 5% (slope from 0 to 5cm per meter). For good run-off of rain water, the minimum slope should be 2%.

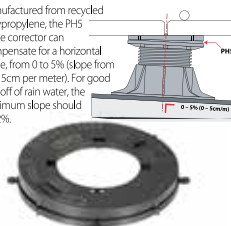

Joist/Batten Holder

Support for all types of joists or battens:

- Timber batten or joists
- Composite Timber battens or joists
- Aluminium/Steel sections

Width of the holder is 65mm with holes on the sides for a mechanical fixing.



Adjustable Joist / Batten Holder

Support for all types of joist or battens:

- Timber batten or joists
- Composite timber battens or joists.
- Aluminium / steel sections

Adjustable from 35 – 90mm with holes on the sides for a mechanical fixing.



FEATURES:

- Designed & manufactured in Belgium
- Made from 5mm thick 80% recycled polypropylene
- 2, 3, 4.5, 6, 8 & 10mm Paver Spacer Tabs
- Adjustable heights from 17mm to 1070mm
- UV stable & chemical resistant
- Provision for mechanical fixing if required
- Inbuilt safety locking mechanism
- Millimetric adjustment

BENEFITS:

- Provides a sustainable solution
- Easy access to waterproofing membrane
- Allows for positive drainage & air ventilation
- Reduces sound transmission & increases temperature insulation
- Ability to conceal services (i.e. plumbing, electrical etc)
- Compensates for 0-5% fall
- Will support up to 1000Kg to a height of 1070mm
- Quick & easy installation
- Reduces weigh loading by eliminating sand & cement mortar beds



All Types of Timber & Composite Decking



Pedestal + Joist/Batten Holder

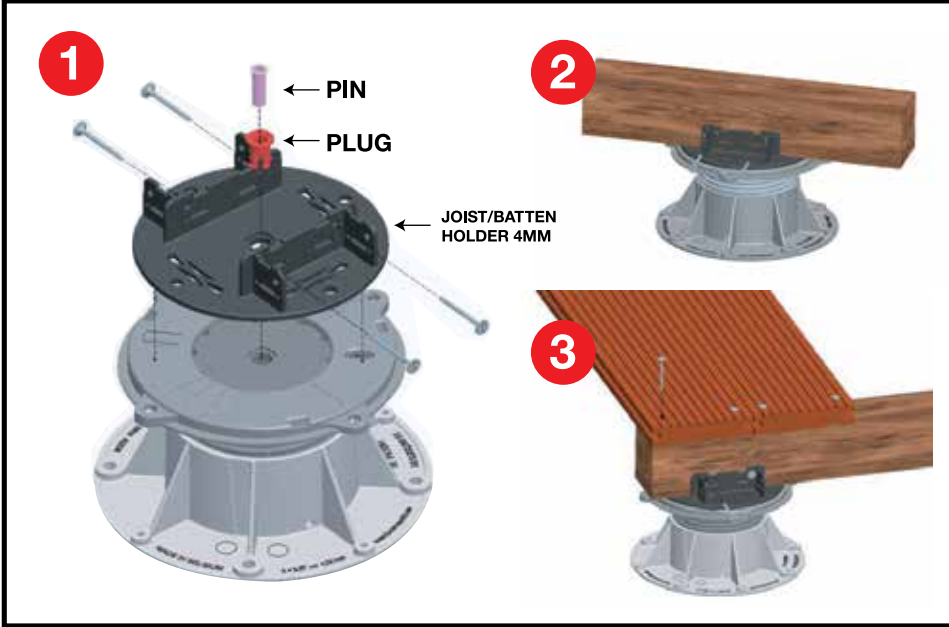



All Types of Pavers & Stone

The Buzon height adjustable pedestal has a unique 0 – 5% slope compensation device, invented and patented by Claude Buzon

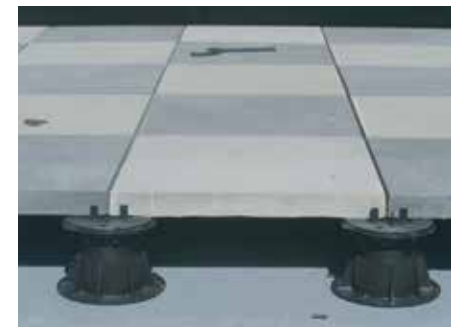

PASCO

Head Office (VIC)
13-15 Brighton St
Richmond VIC 3121
Tel: (03) 9429 9111
Fax: (03) 9429 6111

NSW Distributor
Ausdrain
Suite 10, 2-4 Bells Ave
Cammeray NSW 2062
Tel: (02) 9929 7650
Fax: (02) 9929 7655

WA Distributor
Civil & General Distributors
27 Oxleigh Drive
Malaga, WA 6090
Tel: (08) 9249 4733
Fax: (08) 9209 1220

SA Distributor
P. Hughes Enterprises
15 Saltram Rd
Glenelg, SA 5045
Tel: 0432 418 255
Fax: (08) 8376 3094

QLD Distributor
Adheseal - Brisbane
26 Wolverhampton St
Stafford QLD 4053
Tel: (07) 3356 0000
Fax: (07) 3356 0005

QLD Distributor
Adheseal - Sunshine Coast
2/18 Kessling Ave
Kunda Park QLD 4556
Tel: (07) 5477 0022
Fax: (07) 5477 0020



DPH-0 - Buzon (17mm Non Adjustable Pedestal)

The DPH-0 is a 17mm fixed height pedestal and is the lowest fixed pedestal in the DPH range. There is a selection of Buzon accessories available to support raised floors in outdoor and indoor applications. Adding the optional Buzon PH5 slope corrector will add 9mm to the pedestal height.

Size	Code
17mm	BUZDPH/0



DPH-1 - Buzon (28mm Non Adjustable Pedestal)

The DPH-1 is a 28mm fixed height pedestal and is the highest fixed pedestal in the DPH range. There is a selection of Buzon accessories available to support raised floors in outdoor and indoor applications. Adding the optional Buzon PH5 slope corrector will add 9mm to the pedestal height.

Size	Code
28mm	BUZDPH/1



DPH-02 - Buzon (25-36mm Screwjack Pedestal)

The DPH-02 pedestal has an adjustable height range from 25 to 36mm. There is a selection of Buzon accessories available to support raised floors in outdoor and indoor applications. Adding the optional Buzon PH5 slope corrector will add 9mm to the pedestal height.

Size	Code
25-36mm	BUZDPH/02



DPH-2 - Buzon (35-53mm Screwjack Pedestal)

The DPH-2 pedestal has an adjustable height range from 35 to 53mm. There is a selection of Buzon accessories available to support raised floors in outdoor and indoor applications. Adding the optional Buzon PH5 slope corrector will add 9mm to the pedestal height.

Size	Code
35-53mm	BUZDPH/2



DPH-3 - Buzon (50-78mm Screwjack Pedestal)

The DPH-3 pedestal has an adjustable height range from 50 to 78mm. There is a selection of Buzon accessories available to support raised floors in outdoor and indoor applications. Adding the optional Buzon PH5 slope corrector will add 9mm to the pedestal height.

Size	Code
50-78mm	BUZDPH/3



DPH-4 - Buzon (75-108mm Screwjack Pedestal)

The DPH-4 pedestal has an adjustable height range from 75 to 108mm with an integrated slope corrector that compensates for a horizontal slope from 0 - 5% or 0 - 5cm per metre. There is a selection of Buzon accessories available to support raised floors in outdoor and indoor applications.

Size	Code
75-108mm	BUZDPH/4



DPH-5 - Buzon (100-175mm Screwjack Pedestal)

The DPH-5 pedestal has an adjustable height range from 100-175mm with an integrated slope corrector that compensates for a horizontal slope from 0 - 5% or 0 - 5cm per metre. There is a selection of Buzon accessories available to support raised floors in outdoor and indoor applications. Using Buzon couplers can increase the height for installations up to 1070mm.

Size	Code
100-175mm Screwed	BUZDPH/5
100-175mm Un-Screwed	BUZDPH/5UNS



Coupler - Buzon

Couplers are added to the DPH-5 pedestal to extend the height range of the pedestal. Using Buzon couplers can increase the height for installations up to 1070mm.

Size	Code
C2	For heights 170mm BUZC/2
C5	For heights 285mm BUZC/5



Shims - Buzon

For use with marble, granite and stone pavers. The shims act as a shock absorber and compensates for the difference in thickness of pavers during the installation.

Size	Code
1mm	BUZSHIM/1
2mm	BUZSHIM/2



Joist/Batten Holder - Buzon

A joist or batten holder that clips to the top of the DPH Pedestal series to support all types of battens and will accommodate up to a 65mm wide joist with holes on the side for mechanical fixing. The Joist/Batten Holder also requires a locking pin and plug and will increase the pedestal height by 4mm.

Size	Code
Up to 65mm	BUZJBH



Adjustable Joist / Batten Holder Support - Buzon

An adjustable joist or batten holder that clips to the top of the DPH Pedestal series to support all types of joists or battens. It has an adjustable width from 35 - 90mm and has holes on the sides for mechanical fixing. The Adjustable Joist/Batten Holder also requires a locking pin and plug and will increase the pedestal height by 10mm.

Size	Code
35-90mm	BUZAJBH



PH5 Slope Corrector - Buzon

The slope corrector adjusts the angle of the head to compensate for a horizontal slope from 0 - 5% or 0 - 5cm per metre, therefore allowing the head of the pedestal and in turn the finished surface to be perfectly level. The PH5 Slope Corrector can be used with DPH0, DPH1, DPH02, DPH2 & DPH3. Using this product will increase the pedestal height by 9mm.

Size	Code
-	BUZPH/5



Spacer Tabs - Buzon

The spacer tabs are designed for Buzon tile and paver installations. They clip to the top of the chosen pedestals to achieve the desired opening between pavers for water drainage and ventilation. Plug is not required for Spacer Tabs.

Size	Code
2mm	BUZST/2
3mm	BUZST/3
4.5mm	BUZST/4
6mm	BUZST/6
8mm	BUZST/8
10mm	BUZST/10



Plug - Buzon

First part of a two-part locking mechanism to secure the Buzon Joist Batten Holder to the DPH pedestals. The plug size required will depend on the pedestal and accessory combination used.

Medium Plug:

- For all DPH pedestals except when combined with PH5 Slope Corrector or Buzon Adjustable Joist Holders

Long Plug:

- Suitable for DPH-0 to DPH-3 pedestals in combination with using a PH5 Slope Corrector
- Suitable for all DPH pedestal sizes when using the Buzon Adjustable Batten Holder

Size	Code
Medium	BUZPLUGM
Long	BUZPLUGL



Pin - Buzon

Second part of a two part locking mechanism to secure the Buzon accessories to the DPH pedestals. The pin size required will depend on the pedestal used.

Size	Code
Long (for all DPH pedestal except DPH-0)	BUZPINL



*The Original
and The Best*



RAIMONDI
Professional Tiling Tools.
Exclusively Distributed by B.A.T. Trims



1800 BAT TRIMS (1800 228 874)
www.battrims.com



RLS Starter Kit

Raimondi Levelling System (RLS) ensures precise levelling of tiles and assists to speed up the tile setting process. RLS is strongly recommended when installing flexible, large format, heavy or low-thickness tiles. Kit includes: floor pliers, 100 small base clips and 100 wedges.

Size	Code
RLS Starter Kit	RLSSTART



RLS Large Base Clips

Raimondi Levelling System large base clips. Minimum joint width 1.5mm. Tile thickness 12 - 20mm.

Size	Code
200 Pieces	RLSCLIPLG/200
400 Pieces	RLSCLIPLG/400
1500 Pieces	RLSCLIPLG/1500



RLS Small Base Clips

Raimondi Levelling System small base clips. Minimum joint width 1.5mm. Tile thickness 3 - 12mm.

Size	Code
100 Pieces	RLSCLIPSM/100
250 Pieces	RLSCLIPSM/250
500 Pieces	RLSCLIPSM/500



RLS Wedges

Raimondi Levelling System Wedges. Suits both small & large base clips. RLS wedges are reusable.

Size	Code
100 Pieces	RLSWEDGE/100
250 Pieces	RLSWEDGE/250
500 Pieces	RLSWEDGE/500



RLS Adjustable Traction Pliers

Raimondi Levelling System adjustable floor or wall pliers.

Size	Code
RLS Floor Pliers	RLSPLIERFLOOR
RLS Wall Pliers	RLSPLIERWALL



RLS Replacement Traction Plier Protective Cap

Raimondi Levelling System replacement protective cap for floor and wall adjustable traction pliers.

Size	Code
-	RLSPLIERCAP

Adheseal

Solvents, Thinners & Cleaning



Cleaning Solvent Aerosol

A blend of solvents in an aerosol for easy application. Designed to remove grease, oil, dirt and contaminants from non-porous surfaces before applying adhesives or tapes.

Type	Code
Aerosol	CLEANPRIME



Polyurethane NBS Gun Cleaner - Adheseal

Solvent based cleaner in an aerosol specifically designed for cleaning Adheseal PU Foam Application Guns after use.

Size	Code
500g	FOAMPUCLEAN



Acetone - Adheseal

A powerful solvent for cleaning difficult resins, waxes and adhesives.

General uses

- General clean-up
- Removing and clean-up of many adhesives
- Preparing and cleaning substrates and tools before adhesive or sealant application
- Thinner for some adhesives

Size	Code
1L	ACETONE/1
20L	ACETONE/20
200L	ACETONE/200



White Spirits - Adheseal

A milder solvent commonly used for cleaning and thinning applications.

Size	Code
20L	WHITESPIRITS/20



Methylated Spirits - Adheseal

A denatured alcohol commonly used as an adhesive thinner for some adhesives and also as a general-purpose cleaning agent on non-porous surfaces.

General uses

- General clean-up
- Removing and clean-up of many adhesives
- Preparing and cleaning substrates and tools before adhesive or sealant application
- Thinner for some adhesives

Size	Code
20L	METHO/20
200L	METHO/200



Xylene - Adheseal

A solvent commonly used for cleaning, thinning and stripping some adhesives and sealers.

Size	Code
20L	XYLENE/20
205L	XYLENE/205



Toluene - Adheseal

A solvent commonly used as a thinner for some adhesives and sealants and is also suitable for the clean-up of adhesives such as contact adhesive, PU sealants and applications where a high level of solvency is required.

Size	Code
1L	TOLUENE/1
20L	TOLUENE/20
200L	TOLUENE/200



Thinners - Megapoxy

A blend of solvents suitable for thinning and cleaning some adhesives.

Size	Code
20L	MPTHIN/20



Adhesive Cleaner 103 - Adheseal

A milder cleaning solvent formulated to clean contact adhesive from surfaces which may be affected by more aggressive solvent cleaners. Adhesive Cleaner 103 is also suitable for thinning Adheseal SP230 contact adhesive.

Size	Code
1L	ADHCLEAN103/1
20L	ADHCLEAN103/20



I.P.A. Cleaner - Adheseal

IPA is an alcohol based cleaning solution suitable for non-porous surfaces.

Size	Code
1L	IPA/1
20L	IPA/20
200L	IPA/200



SilOut Silicone Remover - Ottoseal

A thixotropic paste designed for easy removal of cured silicone sealants and adhesives. SilOut removes silicone from wood, brickwork, plaster, concrete, glass, porcelain, metals and plastics.

Size	Colour	Code
300ml Cartridge	White	SILOUT



StainEx - Ottoseal

Marble and natural stone degreasing paste. StainEx removes grease and oils from marble and natural stone where unsuitable sealants have caused migratory staining around the edges of the joints. Successful usage may avoid expensive refurbishment of natural stone.

Size	Colour	Code
300ml Cartridge	White	STAINEX

Degreaser



100 Uses Super-Strip Degreaser - Adheseal

A hi-performing concentrated degreaser that cuts through the heavy contamination of oil, grease, carbon and more. 100 Uses is a heavy duty concentrate and is designed to be diluted to suit the application.

- Suitable for**
- Automotive
 - Workshops
 - Construction sites
 - Industry

Size	Code
5L	USES/5
20L	USES/20
200L	USES/200

Cleaning Wipes



Handy Wipes - Aftek

Citrus based, waterless disposable cleaning towels ideal for cleaning your hands and tools. Aftek Handy Wipes easily removes silicone, polyurethane, dirt, grease and other industrial products without the need for harsh solvents.

Size	Code
100 Wipes	WIPESAFT



Mixed Coloured Rags

Variety of absorbent cotton grades. Ideal for construction and manufacturing industries.

Size	Code
1kg	RAGSMIX/1
5kg	RAGSMIX/5



White T Shirt Rags

Light/medium weight white t-shirt fabric. No dye run from thinners. Soft and absorbent cleaning/polishing cloth.

Size	Code
10kg	RAGSWH/10

Adheseal

100 Uses

Superstrip Degreaser

Commercial Grade Degreaser

A hi-performing concentrated degreaser that cuts through the heavy contamination of oil, grease, carbon and more. 100 Uses is a heavy duty concentrate and is designed to be diluted to suit the application.

Suitable for

✓ Workshops

✓ Automotive

✓ Boats/Marine

✓ Construction Sites

✓ Manufacturing

✓ Agricultural/Farms

✓ Transport Industry

✓ DIY

Adheseal

Unobond

Woodworking / Outdoor / Marine

Super Strength Polyurethane Adhesive



Low VOC



Solvent Free



Fast Setting



Heat resistant



Acid & chemical resistant



D4 classified water resistant



Paintable and sandable



Super strong bond



Structural strength



Unobond is a single component, quick setting, moisture cured polyurethane adhesive. Commonly used for structural applications. It has excellent water resistance and provides an extremely strong structural bond.

Applications

- Ideal for woodworking
- Marine applications
- Outdoor applications
- Difficult to bond surfaces

Bonds

- Wood
- Metal
- Masonry
- MDF
- Polystyrene
- Many plastics
- Most common building materials

COHESIVE STENGTH ★★★★★ ELASTICITY ★☆☆☆☆

Adheseal
The Adhesive and Sealant Specialists

Adheseal Head Office
26 Wolverhampton Street
Stafford, Queensland 4053
Phone: (07) 3356 0000
sales@adheseal.com.au

Adheseal Sunshine Coast
2/18 Kessling Ave
Kunda Park, Queensland 4556
Phone: (07) 5477 0022
sc@adheseal.com.au

www.adheseal.com.au

Adheseal

Construction Essentials



General Purpose Masking Tape

General purpose masking tape.

Size	Code
24mm x 50mt	MASKTAPE/24
36mm x 50mt	MASKTAPE/36
48mm x 50mt	MASKTAPE/48

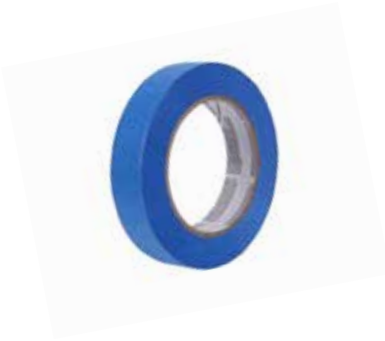

Blue Masking Tape

Commercial and domestic masking. Good resistance to solvents. 14 day UV resistance.

Size	Code
24mm x 50mt	MASKTAPEBL/24
36mm x 50mt	MASKTAPEBL/36
48mm x 50mt	MASKTAPEBL/48

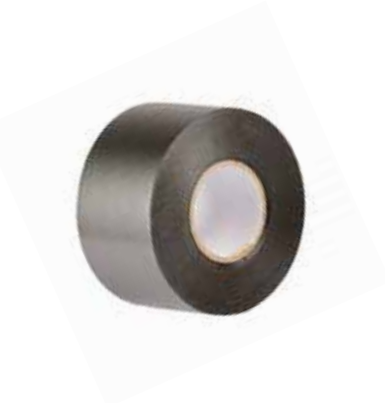

Duct Tape

Single-sided PVC tape designed for pipe lagging, joining plastic sheeting and other general purpose applications.

Size	Code
48mm x 50mt	DUCTTAPE/48



Reinforced PVC Tape

A cloth reinforced PVC tape that has high tensile strength for wrapping bundling. It has excellent adhesion to most surfaces.

Size	Code
48mm x 50mt	TAPE100MPH/48



Bond Breaker All Weather Tape

Used in joint sealing applications to prevent three sided adhesion. Ensuring adhesion between only two surfaces of an expansion joint will maximise movement capabilities of the sealant.

Size	Code
8mm x 50mt	BONDB/8
15mm x 50mt	BONDB/15

Open Cell Backing Rod - Round

Open cell foam backing rod for caulking and sealant applications.



Size	Code
10mm x 210mt	FOAMOC/10
16mm x 150mt	FOAMOC/16
22mm x 100mt	FOAMOC/22
29mm x 60mt	FOAMOC/29
38mm x 30mt	FOAMOC/38
50mm x 20 mt	FOAMOC/50

Open Cell Backing Rod - Square

Open cell foam backing rod for caulking and sealant applications.



Size	Code
25 x 20 x 2000mm	FOAMSQ/2520
45 x 30 x 2000mm	FOAMSQ/4530

Closed Cell Backing Rod - Round

Closed cell foam backing rod for caulking and sealant applications.



Size	Code
6mm x 250mt	FOAMCC/6
10mm x 250mt	FOAMCC/10
13mm x 50mt	FOAMCC/13
15mm x 50mt	FOAMCC/15
20mm x 50mt	FOAMCC/20
25mm x 50mt	FOAMCC/25
30mm x 50mt	FOAMCC/30

Rigi Joint

Rigi Joint is a high density backing material for trafficable joints with a high point load.



Size	Code
20 Lengths x 9mm x 50mm x 2mt (40mt total)	RIGI/50
20 Lengths x 9mm x 100mm x 2mt (40mt total)	RIGI/100

Fire Rated Backing Rod

Fire rated backing rod for caulking and sealing applications. Certified for use with Adheseal PU-25 & Everflex JS.



Size	Code
30mm x 25mm x 2mt	FIREFOAM/30
40mm x 25mm x 2mt	FIREFOAM/40



Biyseal Bitumen Impregnated Foam Lengths

Suitable as a weather resistant seal for many applications.

Features

- Vertical expansion joints in precast concrete / brick or block work
- Jointing between walls and window
- Sealing various roofing and wall decking applications
- Backing channel foam

Size	Code
10 Lengths x 25mm x 25mm x 2mt (20mt total)	BIYSEAL/2525
10 Lengths x 30mm x 30mm x 2mt (20mt total)	BIYSEAL/3030
10 Lengths x 40mm x 40mm x 2mt (20mt total)	BIYSEAL/4040
10 Lengths x 50mm x 25mm x 2mt (20mt total)	BIYSEAL/5025
Trim Deck - 5 lengths x 2mt (10mt total)	BIYSEALTRIMDECK
D Profile - 5 lengths x 2mt (10mt total)	BIYSEALPROFILED

Angles & Trims



Plastic Angles

PVC plastic angles are commonly used as a water stop for wet areas such as bathrooms, laundries and balconies. PVC angle can be easily trimmed to size.

Size	Code
12 x 12 x 1.5 x 3600mm	ANGPL12X1.5/3600
19 x 19 x 2.5 x 3600mm	ANGPL19X2.5/3600
25 x 25 x 1.5 x 3600mm	ANGPL25X1.5/3600
47 x 47 x 4.0 x 3600mm	ANGPL47X47/3600



Aluminium Angles

Mill finish aluminium angle.

Size	Code
25 x 12 x 1.6 x 2165mm	ANGAL25x12X1.6/2165
25 x 12 x 3.0 x 2165mm	ANGAL25X12X3/2165
32 x 20 x 1.6 x 2165mm	ANGAL32X20X1.6/2165
32 x 20 x 3.0 x 2165mm	ANGAL32X20X3/2165
40 x 20 x 1.6 x 2165mm	ANGAL40X20X1.6/2165
40 x 20 x 3.0 x 2165mm	ANGAL40X20X3/2165
50 x 25 x 1.6 x 2165mm	ANGAL50X25X1.6/2165
50 x 25 x 3.0 x 2165mm	ANGAL50X25X3/2165



Adheseal Balcony Drip Angle

Decorative anodised aluminium balcony trim with functional drainage holes and drip edge. The drainage holes allow water in the mortar bed to drain freely to the functional drip edge which directs the water off the facade of the building preventing unsightly and weeping tile joints.

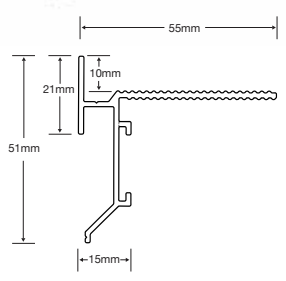

Size	Finish	Code
10mm x 2.5mt	Anodised	BALALAN10/2.5
10mm x 5mt	Anodised	BALALAN10/5

Also available in mill finish on request.



INVEST IN THE BEST



1800 BAT TRIMS (1800 228 874)
www.battrims.com



B.A.T Trim L Shaped Perforated Tile Angle

Used for edge protection on floor or wall tiles and also as a decorative feature in tiling applications.

Available aluminium dimensions (refer diagram A):

- 4.5mm
- 6mm
- 8mm
- 9mm
- 10mm
- 11mm
- 12.5mm
- 13.5mm
- 15mm
- 17mm
- 18.5mm
- 20mm
- 22mm

Finishes

- Mill Finish - Aluminium
- Bright Silver - Aluminium
- Linished Silver - Aluminium (8, 10, 12.5mm only)

- Brass
- Chrome Plated Brass
- Stainless Steel

- Coloured Aluminium (Powder Coated)
 - Alabaster
 - Gloss Black
 - Pearl White

Size	Finish	Code
4mm x 3mt	Mill Finish	TILEANGMF4
4mm x 3mt	Bright Silver	TILEANGBS4
6mm x 3mt	Mill Finish	TILEANGMF6
6mm x 3mt	Bright Silver	TILEANGBS6
8mm x 3mt	Mill Finish	TILEANGMF8
8mm x 3mt	Bright Silver	TILEANGBS8
9mm x 3mt	Mill Finish	TILEANGMF9
9mm x 3mt	Bright Silver	TILEANGBS9
10mm x 3mt	Mill Finish	TILEANGMF10
10mm x 3mt	Bright Silver	TILEANGBS10
11mm x 3mt	Mill Finish	TILEANGMF11
11mm x 3mt	Bright Silver	TILEANGBS11
12mm x 3mt	Mill Finish	TILEANGMF12
12mm x 3mt	Bright Silver	TILEANGBS12



B.A.T Trim Half Round Tile Trim

Designed to protect the outside edge of a tiled surface.

Finishes

- Mill Finish - Aluminium
- Bright Silver - Aluminium
- Linished Silver - Aluminium (8, 10, 12mm only)

- PVC
- Brass
- Chrome Plated Brass
- Stainless Steel

- Coloured Aluminium (Powder Coated)
 - Alabaster
 - Gloss Black
 - Pearl White

Size	Finish	Code
6mm x 3mt	Bright Silver	TILEHALFRBS6
8mm x 3mt	Bright Silver	TILEHALFRBS8
10mm x 3mt	Bright Silver	TILEHALFRBS10
12mm x 3mt	Bright Silver	TILEHALFRBS12

B.A.T Trim Mosaic Corner (Box) Trim

Provides a square edge finish to tile and wall cladding installations.

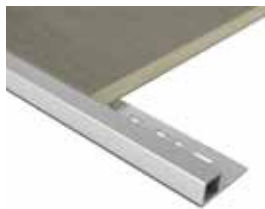

Available aluminium dimensions (refer diagram A):

- 4.5mm
- 6.5mm
- 8.5mm
- 10.5mm
- 12.5mm
- 15mm

Finishes

- Mill Finish - Aluminium
- Bright Silver - Aluminium
- Linished Silver - Aluminium

- Brass
- Chrome Plated Brass
- Stainless Steel

- Coloured Aluminium (Powder Coated)
 - Alabaster
 - Gloss Black
 - Pearl White

Size	Finish	Code
4mm x 3mt	Bright Silver	TILEBOXBS4
6mm x 3mt	Bright Silver	TILEBOXBS6
8mm x 3mt	Bright Silver	TILEBOXBS8
10mm x 3mt	Bright Silver	TILEBOXBS10
12mm x 3mt	Bright Silver	TILEBOXBS12
15mm x 3mt	Bright Silver	TILEBOXBS15

B.A.T Trim Diminishing Tile Angle

Provides a ramped transition from one flooring surface to another.



Available aluminium dimensions (refer diagram A):

- 8mm
- 10mm
- 12.5mm
- 15mm

Finishes

- Mill Finish - Aluminium
- Matt Silver - Anodised Aluminium
- Brass

Size	Finish	Code
8mm x 3mt	Matt Silver	TILEDIMMS8
10mm x 3mt	Matt Silver	TILEDIMMS10
12mm x 3mt	Matt Silver	TILEDIMMS12
15mm x 3mt	Matt Silver	TILEDIMMS15

B.A.T Trim Expansion Joint

For expansion joints between tiles.

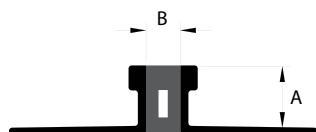

Available aluminium dimensions (see diagram)

A

- 8mm
- 9mm
- 10mm
- 11mm
- 12.5mm
- 13.5mm
- 15mm
- 17mm
- 18.5mm
- 22mm

B

- 6mm
- 8mm

Neoprene Colours

- Beige
- Black
- Grey

Finishes

- PVC (Black, Grey, White)
- Aluminium
- Brass
- Stainless Steel

Size	Finish	Code
8mm x 3mt	Mill Finish	TILEEXPMF8
9mm x 3mt	Mill Finish	TILEEXPMF9
10mm x 3mt	Mill Finish	TILEEXPMF10
11mm x 3mt	Mill Finish	TILEEXPMF11
12mm x 3mt	Mill Finish	TILEEXPMF12



Hebel Hobs

For use as shower hobs.

Size	Code
50 x 75 x 600mm	HOBHEBEL/75



Polyurethane Hobs

For use as shower hobs.

Size	Code
50 x 75 x 1200mm	HOBPOLY/75

Adheseal

PU-25FC

The Waterproofer's Choice

**Easy Gunning.
Fast Cure.**



Fast Cure Sealant For Fillet Joints Under Waterproofing

Adheseal PU-25FC is a fast curing, single component, moisture curing, polyurethane adhesive / sealant. This tough and durable adhesive / sealant can be used in a wide range of applications such as joint sealing or structural bonding. Suitable for construction, industrial, marine and automotive industries.

- 
Tough & durable
- 
Excellent weathering reistance
- 
Internal & external applications
- 
Paintable
- 
Low Voc
- 
Good UV resistance



Hear what our customers are saying about **Waterstop Streamline**

I am happy to give my recommendation to use Waterstop Streamline. It is the only modern looking product that I have seen that positively connects the shower screen to the waterproofing in a completely leak free way...

Mr Albert Aeberhard
Builder, Hotondo Homes Group ACT

With so many new products on offer in our industry it is difficult to find time to investigate them all. We are very glad we made time for this one.

Mr Dennis Wright
Building and Project Manager, Beazley Homes

My business has expanded rapidly since we started using the Waterstop Streamline hob and now I have tilers voluntarily recommending the Waterstop system - and me - to other builders. Everyone that uses it loves it.

Mr Fred Meddings
Managing Director, Watertight Australia (Waterproofers)

By using Waterstop Streamline I know the shower will be perfect every time. It has to be, because this product is designed to dictate placement of all of the other components to make up the complete shower. It's virtually impossible to stuff it up.

Mr Glen Whitehead
Managing Director, BJM Developments

Waterstop is easy to order with efficient delivery. It has given us the edge on our competitors and is our preferred method of waterproofing and tiling showers.

IF YOU ARE ONE OF OUR
COMPETITORS READING THIS AD
PLEASE IGNORE.

Tony Glover
Tony Glover Tiling & Waterproofing

Using Waterstop Streamline in all our shower areas has made life easy for waterproofing and our tilers.

They are so simple to install and always look very professional.

I recommend to all my clients to use the Waterstop Streamline system in their shower areas.

Mr Kerry Blake
Director, Blake's Waterproofing

Switching to the Waterstop Streamline system has been a fantastic result for the company.

It ticks all the boxes by being modern, sleek, easy to install and failsafe.

Costly repairs associated with leaking shower trays are now a thing of the past.

Luke Pearce
QLD Construction Manager, Devine Homes

Waterstop Streamline - Why would anyone use anything else to build a shower?
At last someone has got a product together that not only works, but it looks good and is so easy for every trade to work with. It even comes with step by step instructions on the protective tape.

Mr Andrew Shailer
Andrew Shailer Tiling

For more information, visit www.waterstopstreamline.com.au
Phone 07 5426 3700 • Fax 07 5426 3711 • Email sales@gleda.com.au



Are your showers ticking time bombs?

Despite builders best efforts, leaking showers are consistently listed in the QBCC's 10 most common defects. Sadly, sometimes this is due to sub-standard workmanship, but most of the time it is the design of the shower itself which is creating the potential for disaster.

Most contractors are at a complete loss as to why, but detailed testing has shown how, by the action of expansion and contraction, water is "pumped" along glue cavities to escape the shower enclosure, no matter how well it is water-proofed.

The best way to prevent the problem is to seal the screen directly to the membrane, and NOT to the tiles.

Waterstop Streamline provides:

- Positive connection between screen and membrane
- Maximises floor area
- Provides a template for following trades
- Ensures correct fall to waste
- Complies with and exceeds AS3740
- Modern, cost effective, one-piece design
- 20 different shapes and sizes
- Minimum change for maximum benefits



My business has expanded rapidly since we started using the Waterstop Streamline hob and I now have tilers recommending the Waterstop Streamline system - and me - to other builders. Everyone that uses it loves it.

Mr Fred Meddings, Managing Director
Watertight Australia (Water-proofers)

By using Waterstop Streamline I know the shower will be perfect every time. It has to be, because this product is designed to dictate placement of all of the other components to make up a complete shower. It's virtually impossible to stuff it up.

Mr Glen Whitehead, Managing Director
BJM Developments

**Remove the doubt. Fit Waterstop Streamline ...
and forget about leaking showers.**

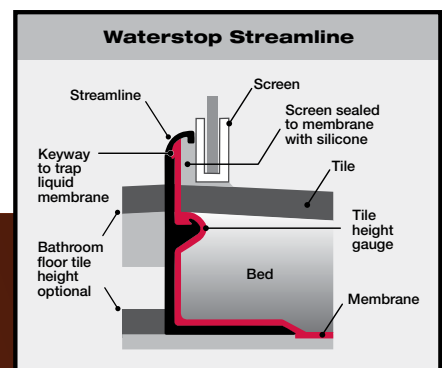
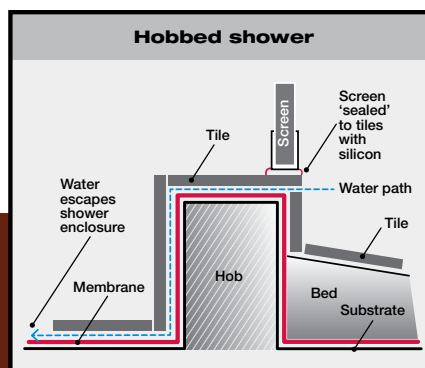
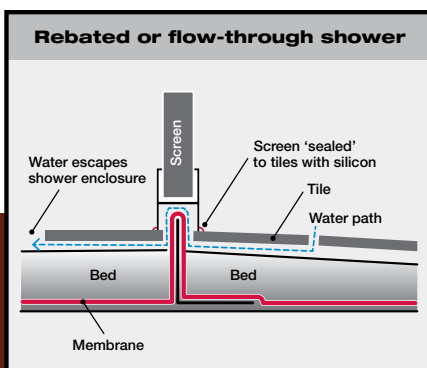

Waterstop Streamline

A functional, decorative, one-piece water barrier that seamlessly connects the shower screen to the shower tray area in an almost invisible way. Waterstop Streamline is installed in place of a hob, standard angle or recess into slab to provide long-term superior waterproof construction with the added benefit of modern appearance. The lengths can be easily trimmed on site with a standard hacksaw.

Standard finishes:

Bright Silver, Brushed Aluminium, Pearl White, White Birch, Almond Ivory and Black. Other colours are available upon request.

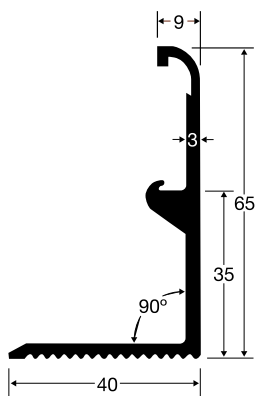

Straight lengths

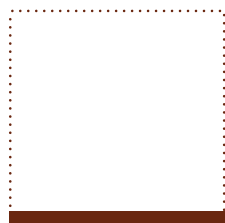

Available sizes

- 1000mm
- 1500mm
- 2000mm
- 3000mm

90° corner range

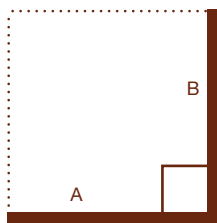

Available sizes

- 900 x 900mm
- 1000 x 1000mm
- 1200 x 1200mm
- 1400 x 1400mm
- 1500 x 1500mm
- 1500 x 1000mm

Truncated corner range

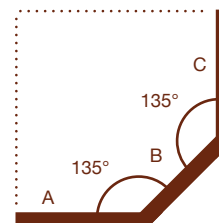

Available sizes

- 540 x 650 x 540: 2 x 135° (3 leg)
- 700 x 700 x 700: 2 x 135° (3 leg)
- 900 x 700 x 900: 2 x 135° (3 leg)
- 1000 x 1000: 1 x 135° (2 Leg)
- 1200 x 1200: 1 x 135° (2 Leg)

Size	Finish	Code
1000mm Straight	Bright Silver	WATERSTBS/1000
1500mm Straight	Bright Silver	WATERSTBS/1500
2000mm Straight	Bright Silver	WATERSTBS/2000
3000mm Straight	Bright Silver	WATERSTBS/3000
900 x 900 90° Corner	Bright Silver	WATERSTCNBS/900
1000 x 1000 90° Corner	Bright Silver	WATERSTCNBS/1000
1200 x 1200 90° Corner	Bright Silver	WATERSTCNBS/1200

Waterstop Doorline

A decorative door sill extrusion to improve the appearance of the entry to the wet area. It is designed for applications where the floor is bedded or screeded allowing a consistent, cohesive look to be maintained throughout the bathroom.

Features

- Easily trimmed on site with a hacksaw
- Aesthetically matches Waterstop Streamline showers
- Serrated surface of the internal vertical leg allows waterproofing membranes to securely adhere to the extrusion, providing enhanced waterproofing
- Bright silver anodised finish

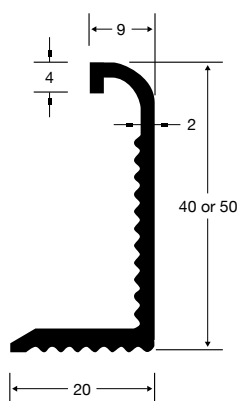

Size	Finish	Code
40mm x 1mt	Bright Silver	WATERSTDR40X1000
40mm x 3mt	Bright Silver	WATERSTDR40X3000
50mm x 1mt	Bright Silver	WATERSTDR50X1000
50mm x 3mt	Bright Silver	WATERSTDR50X3000



Kiln Dried Sand

Size	Weight	Code
0.25mm	20kg Bag	SAND/2.5
0.60mm	20kg Bag	SAND/0.6
1.00mm	20kg Bag	SAND/1

Waterproofing Reinforcement & Protection Products

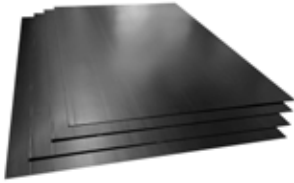

Corflute Protection Board

For membrane protection.

Size	Code
1805 x 1210 x 2mm (2.1m ²)	CORFLUTE/2.1



Geo Fabric

Geo textile fabric used for membrane protection whilst still allowing adequate drainage.

Size	Code
2mt wide x length cut to size (50mt roll)	GEOFAB/1000



Polyester Reinforcing Fabric - Easy Fold

Polyester mat for reinforcing corners and joints in waterproofing applications. This easy fold mat makes it easy to form corners and is a good general purpose reinforcing fabric.

Size	Code
100mm x 30mt	REOFABFD/100/30
100mm x 100mt	REOFABFD/100
150mm x 100mt	REOFABFD/150
1000mm x 100mt	REOFABFD/1000



Polyester Reinforcing Fabric - Easy Form

Softer polyester mat for reinforcing corners and joints in waterproofing applications when the substrate is rough or uneven.

Size	Code
83mm x 100mt	REOFABFM/83
100mm x 100mt	REOFABFM/100
150mm x 100mt	REOFABFM150
1000mm x 100mt	REOFABFM/1000



Fibreglass Reinforcing Mat 225gsm

Fibreglass mat for reinforcing corners and joints in waterproofing applications.

Size	Code
100mm x 125mt	FIBREGL225/100
150mm x 125mt	FIBREGL225/150



Leak-Seal Tape - Duram

Leak-Seal Tape is a self-adhesive, waterproofing membrane / reinforcing fabric. Used in conjunction with Duram waterproofing membranes, it provides a good method for waterproofing and sealing joints on corners and cracks.

Size	Code
80mm x 15mt	LEAKSEALDUR/80



Mapeband - Mapei

A rubber tape with alkali-resistant fabric for cementitious waterproofing systems.

Applications

- Waterproofing corners between adjacent walls and between walls and floors before applying Mapelastic or Mapelastic Smart
- Flexible waterproofing of expansion joints on terraces, balconies and more before applying Mapelastic or Mapelastic Smart
- Sealing pipes and drains in bathrooms, showers and kitchens in conjunction with Mapeband Gaskets
- Sealing expansion joints in precast panels



Size	Code
120mm x 50mt roll	MAPEBAROLL/50
120mm x 10mt roll	MAPEBAROLL/10
90° angular	MAPEBAANG/90
270° angular	MAPEBAANG/270
120 x 120mm outlet gasket	MAPEBAGAS/120
400 x 400mm outlet gasket	MAPEBAGAS/400
515 x 315mm cross piece	MAPEBACROSS
515 x 315mm T piece	MAPEBATEE



Mapeband TPE - Mapei

For flexible sealing and waterproofing expansion joints and over cracks subject to movement.

Applications

- Flexible waterproofing seal of expansion joints subject to large amounts of movement
- Flexible waterproof seal in tunnels and road-works
- Sealing expansion joints in prefabricated panels
- Sealing structural joints in facades
- Sealing joints in hydraulic works such as channels, basins, drains pipe-works and more

Size	Code
Mapeband TPE 170	17cm x 30mt MAPEBATPE/170
Mapeband TPE 325	32.5cm x 30mt MAPEBATPE/325



BOUNTYBRASSWARE

Designer Bathroom Fittings

Bounty Brassware is the trusted name in designer bathroom fittings, combining clever designs with superior quality to enhance your bathroom's look, feel and function.

DESIGNER BATHROOM FITTINGS



BERMUDA RANGE
FLOOR GRATE



BERMUDA MEGA RANGE
FLOOR GRATE

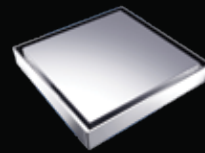

DELUXE MEGA FLIPPER



BERMUDA CHANNEL
FLOOR GRATE

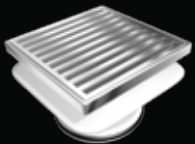

SQUARE ON SQUARE
FLOOR GRATE

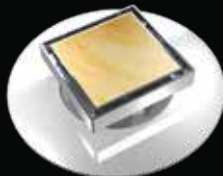

LEAK CONTROL BERMUDA
FLOOR GRATE



NEW ROUND BERMUDA
FLOOR GRATE



CLASSIC RANGE
FLOOR GRATE

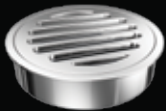

SS316 RANGE
FLOOR GRATE



POP DOWN WASTE



BOTTLE TRAP

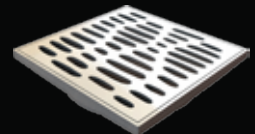

FLOW ORGANICS
FLOOR WASTE CP

Visit www.bountybrassware.com.au to see a great range of designer floor wastes by Bounty Brassware

Email: sales@bountybrassware.com.au
Phone: 02 9896 7760 | Fax: 02 9636 2498

Proudly distributed by
Collis Marketing Service

sales@collismarketing.com.au
Phone: 07 3805 6664
Fax: 07 3805 6668

ORGANICS FLOOR WASTES

Elegant, beautiful and functional... the Organics selection of floor wastes by Bounty Brassware. A choice of designs to suit any bathroom style. Enjoy the classic look of the 2 Woven options, or style your bathroom with the contemporary look of the Flow or Dreamtime designs.

Solid cast and forged brass construction that allows you to update your floor waste without updating your floor.



BERMUDA

The flagship of the Bounty Brassware range, the Bermuda floor grate system is a simplistically discreet solution for any bathroom or wet area. Bermuda cleverly incorporates the selected floor tiles (or a feature tile) to blend beautifully with any environment. Water simply disappears from your bathroom / shower floor.



BOTTLE TRAP

The Bounty Brassware Bottle Trap is designed to elegantly complement any bathroom. Simplistic in design while remaining highly functional and easy to install.

POP DOWN WASTE

LOOKS BETTER. *IS BETTER!*

- At Last – a quick close waste that is approved for basins and baths giving you a consistent look throughout your bathroom.
- Looks Fantastic - Sits flush in the most commonly used 'open position' for a superior aesthetic.
- Works Brilliantly – super smooth opening and closing, along with easy to remove cartridge for cleaning and drain access.





Floor Grate - Chrome Plated Brass - Round / Square

Chrome plated brass grate. Push into PVC.

Size	Shape	Code
50mm	Round	GRATERCB50
80mm	Round	GRATERCB80
100mm	Round	GRATERCB100
50mm	Square	GRATESCB50
80mm	Square	GRATESCB80
100mm	Square	GRATESCB100



Puddle Flanges - PVC

PVC puddle flange only.

Size	Code
50mm	WASTEFL50
80mm	WASTEFL80
100mm	WASTEFL100



Megaflex Standard Floor Waste

(With chrome plated brass grate)

Adjustable chrome plated brass floor grate and PVC leak control flange that fits into PVC pipe using a sealing 'O' ring. Note: This is not a direct stick waste.

Features

- Adjustable chrome plated brass floor grate and PVC flange.
- Available with Round or Square Grates
- Designed as a Leak Control Flange that fits into PVC pipe using a sealing 'O' ring
- Tear out under-cap to keep debris out - remove after tiling

Size	Shape	Code
100mm x 100mm	Round	WASTERRCB100
100mm x 100mm	Square	WASTERSCB100



Megaflex Floor Waste - Stick Down

(With chrome plated brass grate)

Adjustable chrome plated brass floor grate and PVC leak control flange that fits into PVC pipe using a sealing 'O' ring.

Features

- Suitable for direct stick applications
- Grate sits flush for direct stick applications
- Available with Round or Square Grates

Size	Shape	Code
80mm x 50mm	Round	WASTEDSRCB50
80mm x 80mm	Round	WASTEDSRCB80
100mm x 100mm	Round	WASTEDSRCB100
80mm x 50mm	Square	WASTEDSSCB50
80mm x 80mm	Square	WASTEDSSCB80
100mm x 100mm	Square	WASTEDSSCB100

Bermuda Mega Square Floor Waste (With leak control flange)



A stylish, chrome plated floor waste incorporating a square insert suitable for a cut tile. The Bermuda Mega floor grate also comes with a leak control flange.

Size	A (refer diagram)	Type	Code
50mm	27mm	Standard	WASTEBS50
80mm	27mm	Standard	WASTEBS80
100mm	27mm	Standard	WASTEBS100
50mm	23mm	Low Line	WASTEPLL50
80mm	23mm	Low Line	WASTEPLL80
100mm	23mm	Low Line	WASTEPLL100

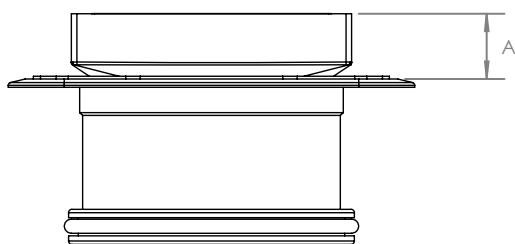

Bermuda Channel Floor Grate (With leak control flange)

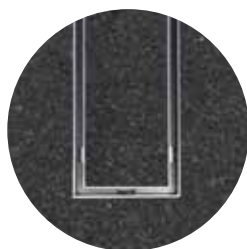

A stylish, chrome plated floor waste incorporating an insert suitable for a cut tile. The Bermuda Channel floor grate also comes with a leak control flange.

Features

- 316 Stainless Steel
- Adjustable height and tilt
- Customised dimensions available

Size	Code
300mm	WASTEBCH300
600mm	WASTEBCH600
900mm	WASTEBCH900
1000mm	WASTEBCH1000
1200mm	WASTEBCH1200

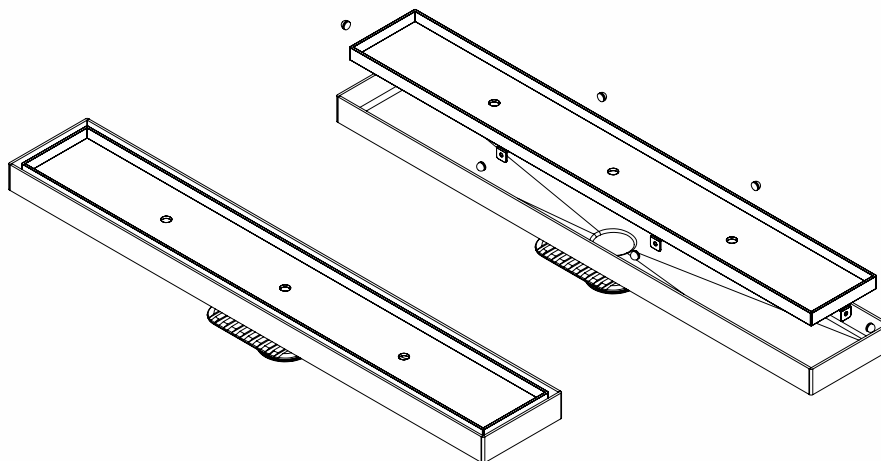



Celleni Linear Channel Grate Kit

A stylish triple anodized aluminium channel grate with a brushed silver finish suitable for indoor and outdoor applications.

Features and benefits

- Easily cut to any length
- 40mm and 50mm wastes available
- Waste can be positioned anywhere along the tray on site
- No welding required, only silicone is needed
- An affordable alternative to stainless steel
- Comes with a lifetime rust proof warranty
- Manufactured from triple anodized aluminium
- Lightweight and easy to clean

Linear Channel Grate Kits	Code
1100mm Grate Kit - includes 2 x end caps / 1 x pop wastes	WASTECELCHSTD/1100
5600mm Grate Kit - includes 10 x end caps / 5 x pop wastes	WASTECELCHSTD/5600

Channel Grate Kits can be cut to size in increments of 100mm.

Accessories	Code
40mm Pop Waste Outlet	WASTECELCHOUT/40
50mm Pop Waste Outlet	WASTECELCHOUT/50
End caps (x2)	WASTECELCHSTDEND

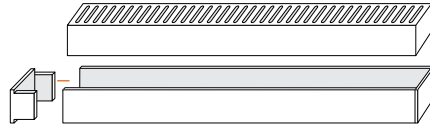
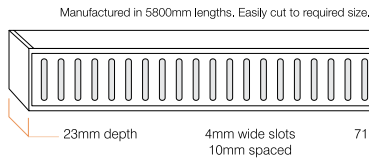

Celleni Tile Insert Channel Wastes

Creates a seamless look in bathrooms or wet areas. Designed to accommodate stone, granite, marble or thick porcelain tiles, easily fitting up to 18mm.

Features and benefits

- Easily cut to any length
- 50mm and 80mm wastes available
- Waste can be positioned anywhere along the tray on site
- No welding required, only silicone is needed
- An affordable alternative to stainless steel
- Comes with a lifetime rust proof warranty
- Manufactured from triple anodized aluminium
- Lightweight and easy to clean
- Can be used in indoor and outdoor application

Plus Tile Insert Channel Waste Kits	Code
1100mm Grate Kit - includes 2 x end caps / 1 x pop wastes	WASTECELCHTILPL/1100
5600mm Grate Kit - includes 10 x end caps / 5 x pop wastes	WASTECELCHTILPL/5600
End caps (pair) 100 x 35mm (Plus)	WASTECELCHTILPEND100

Slimline Tile Insert Channel Waste Kits	Code
1100mm Grate Kit - includes 2 x end caps / 1 x pop wastes	WASTECELCHTILSL/1100
5600mm Grate Kit - includes 10 x end caps / 5 x pop wastes	WASTECELCHTILSL/5600
End caps (pair) 100 x 26mm (Slimline)	WASTECELCHTILSEND100

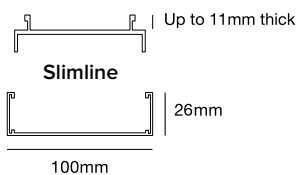
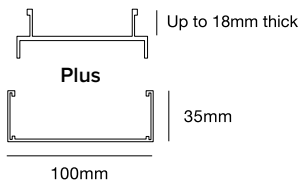

Waste Outlets	Code
40mm Pop Waste Outlet	WASTECELCHOUT/40
50mm Pop Waste Outlet	WASTECELCHOUT50
72mm Pop Waste Outlet	WASTECELCHOUT72
80mm Pop Waste Outlet	WASTECELCHOUT80

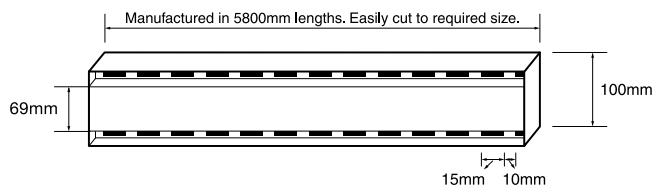

Adheseal

Tools Accessories & Safety Equipment



Industrial Brushes

A cost-effective hog bristle brush with a wooden handle suitable for industrial and marine use.

Size	Code
12mm	BRUSHIND/12
38mm	BRUSHIND/38
50mm	BRUSHIND/50
75mm	BRUSHIND/75
100mm	BRUSHIND/100



Handyman Brushes

A hog bristle brush suitable for general purpose use and waterproofing membrane application.

Size	Code
50mm	BRUSHHAN/50
75mm	BRUSHHAN/75
100mm	BRUSHHAN/100



Polyester Brushes

A polyester bristle brush suitable for general purpose applications.

Size	Code
50mm	BRUSHPOLY/50
75mm	BRUSHPOLY/75
100mm	BRUSHPOLY/100



Mini Paint Roller Covers

Size	Code
100mm	ROLLCM/100



Polyester Paint Roller Covers

Size	Code
230mm	ROLLCP14/230



Microfibre Paint Roller Cover

Size	Code
230mm	ROLLCMF/230



Mini Roller Frames

Size		Code
100mm	Short Handle	ROLLFMS
100mm	Long Handle	ROLLFML



Roller Frame Heavy Duty

Size	Code
230mm	ROLLFHD/230



Telescopic Extension Pole

Size	Code
-	ROLLEXTPT



230mm Paint Tray

Size	Code
230mm	PAINTTRAYE/230



Handyman Cartridge Caulking Gun Type 20 - Adheseal

- Features**
- Handyman caulking gun
 - Steel frame and handle
 - Suitable for cartridges

Size	Code
-	GUNCTG/20



Heavy Duty Cartridge Caulking Gun Type 21 - Adheseal

- Features**
- Premium quality
 - Steel handle and frame
 - Low gearing ratio for easier gunning
 - Anti-wear design for long life
 - Suitable for cartridges

Size	Code
-	GUNCTG/21



Twin Cartridge Gun - Adheseal

High quality dual dispensing cartridge gun suitable for the application of medium to high viscosity two part epoxies, polyureas and other products packaged in dual 300ml cartridges.

Size	Code
-	GUNTWIN/KS



Handyman Sausage Caulking Gun Type 1 - Adheseal

- Features**
- Economy caulking gun for the handyman
 - Suits 600ml sausages

Size	Code
-	GUNSSG/1



Trade Sausage Caulking Gun Type 3 - Adheseal

- Features**
- Trade quality caulking gun designed for the high end user
 - Suits 600ml sausages
 - Convertible to bulk loading

Size	Code
-	GUNSSG/3



Professional Sausage Caulking Gun Type 5 - Adheseal

Features

- Premium quality caulking gun designed for the professional user
- Heavy duty
- Rubber grips
- Can be converted to bulk loading

Size	Code
-	GUNSSG/5



45cm Bulk Loading Caulking Gun

Professional caulking gun suitable for bulk loading.

Size	Code
-	GUNSSG/BULK



Cordless Sausage Caulking Gun ECG 14 - Adheseal

Features

- A professional quality cordless caulking gun
- Suits 600ml sausages
- 2 x long lasting 7.4-volt lithium ion rechargeable batteries
- 2 x speed controls to provide consistent distribution and easy application
- LED light for dark areas
- Carry case

Size	Code
-	GUNSSG/CORD



Cordless Rivet Gun BBR 10 - Adheseal

Features

- A professional quality cordless rivet gun
- 2 x long lasting 7.4-volt lithium ion rechargeable batteries
- Variable torque power control
- Torque power up to 850kg
- Stroke length: 18mm
- Performance - 400 pieces 4.8mm rivets per discharging cycle
- LED light for dark areas
- Carry case

Suitable Rivet Sizes	Size
Aluminium	2.4 - 4.8mm
Steel	2.4 - 4.8mm
Stainless Steel	2.4 - 4.0mm

Size	Code
-	GUN/RIVET



PU Foam Handyman Application Gun - Adheseal

Economy PU foam dispensing gun for the handyman.

Size	Code
-	GUNPU/HANDY



PU Foam Tradesman Application Gun - Adheseal

Trade quality PU foam dispensing gun for high volume applications.

Size	Code
-	GUNPU/TRADE



K-1000 Hot Melt Glue Gun - Adheseal

Heavy duty industrial hot melt glue gun for the low to medium user.

Size	Code
-	GUNHOTMELT/K1000

Application Gun Accessories



19mm Sausage Gun Nozzle (10 pack) - Adheseal

19mm nozzle that suits sausage caulking guns.

Size	Code
19mm	NOZL19/10



38mm Sausage Gun Nozzle (10 pack) - Adheseal

38mm nozzle that suits sausage caulking guns.

Size	Code
38mm	NOZL38/10



Silicone Corner Nozzles (3 pack)

Corner nozzle adaptors for 45° silicone caulking applications.

Size	Code
3 Pack	NOZSILCNR



Silicone Nozzle Extensions (6 pack)

Extension nozzle adaptors for silicone caulking applications.

Size	Code
6 Pack	NOZSILEXT



Black Sausage Gun Plunger

Suits Adheseal cordless caulking gun.

Size	Code
-	EQPLUBLK



Opaque Bulk Loading Plunger Kit

Suits Adheseal trade and professional sausage guns only

Size	Code
-	EQPLUOP/KS



Green Bulk Loading Plunger Kit

Suits 45cm bulk loading gun only.

Size	Code
-	EQPLUGRN/SV



Blue Sausage Gun Plunger

Suits Adheseal handyman, trade and professional sausage guns.

Size	Code
-	EQPLUBL/KS



Hanging Hook for Sausage Gun

Size	Code
-	EQHANGHOOK



Bulk Loading Follower Plate

Size	Code
220-250mm	EQFOLLOW/10

Caulking Accessories



Trigger Spray Bottles

Size	Code
-	SPRAYB/750



Rubber Caulking Application Tool

Size	Code
-	CAULKRUB



Glaziers Spatula

Size	Code
-	CAULKGLASP



Large Disposable Caulking Sticks

Size	Code
50 Pack	CAULKST/L



Small Disposable Caulking Sticks

Size	Code
300 Pack	CAULKST/S



Caulking Blade Set

8 Piece stainless steel caulking blade set. Includes: 10mm, 12.5mm, 15mm, 20mm, 25mm, 30mm, 35mm and 40mm.

Size	Code
-	CAULKBLSET



5 in 1 Caulking Tool

This caulk tool has a 4-sided caulk finisher and can be used to scrape caulk residue, clean caulk detail, cut tube nozzles and shave caulk clean. Folds in half for easy storage.

Size	Code
-	CAULKTOOL/5



Silicone Removing Tool

Size	Code
-	CAULKREMOVER



Measuring Jug

Size	Code
500ml	MEAS/500
1L	MEAS/1
5L	MEAS/5
20L	MEAS/20



Disposable Measuring Tub

A disposable measuring tub with multiple mixing ratios.

Size	Code
1.1L	MPMEASURE



20 Litre Plastic Pail

Lid sold separately.

Size	Code
Pail	PAIL/20
Lid	PAILLID/20

Floor & Wall Scrapers



15 in 1 Tool

Soft touch handle with hammer end, nail puller, concave and convex scraper, screwdriver, bottle opener and more.

Size	Code
-	TOOL15IN1



Stripping Scraper

Stainless steel scraper.

Size	Code
50mm	SCRAPERSS/50
100mm	SCRAPERSS/100



100mm Deluxe Wall Scraper

Size	Code
100mm	SCRAPERWA/100



Floor Scraper - Heavy Duty

Size	Code
Floor Scraper - 150mm (FS150)	SCRAPERFL/150
Floor Scraper - 300mm (FSHD300)	SCRAPERFL/300
Replacement Blade 150mm (FS150RB)	BLADESCR/150
Replacement Blade 300mm (FSHD300RB)	BLADESCR300



Floor / Wall Scraper 125mm

Size	Code
Scraper 125mm (5WFS)	SCRAPER/125
Replacement Blade 125mm (5WFSB)	BLADESCR/125



Floor Scraper 200mm

Extendable 960mm - 1700mm.

Size	Code
Floor Scraper 200mm (FS1700)	SCRAPEREX/200
Replacement Blade 200mm (FS1700RB)	BLADESCREX/200



Notch Trowel

Bright steel with soft grip handle.

Size		Code
4mm	Square Notch	TRONOTBSSQ/4
6mm	Square Notch	TRONOTBSSQ/6
8mm	Square Notch	TRONOTBSSQ/8
10mm	Square Notch	TRONOTBSSQ/10
12mm	Square Notch	TRONOTBSSQ/12
3mm	V Notch	TRONOTBSV/3
5mm	V Notch	TRONOTBSV/5
8mm	V Notch	TRONOTBSV/8
12mm	V Notch	TRONOTBSV/12

Knives & Blades



Trimming Knife

Size	Code
-	KNIFETRISTD



Snap Off Knife Blades

Size	Code
5 Pack	BLADEKNT/5
50 Pack	BLADEKNT/50



Single Edge Scraper Blades - 0.23mm

Size	Code
100 Pack	BLADESCS/100



EM1400 Electric Hand Mixer

Features

- 1400 Watt Motor
- 2 Speed (150 - 300 rpm & 300 - 650 rpm)
- Variable Speed Control
- M14 Thread

Includes

- 1 x 140mm Spiral Mixing Paddle
- 1 x 100mm Whisk Mixing Paddle
- 1 x Carry Case

Size	Code
-	MIXERELEC/EM1400



Double Spiral Liquid Mixer (M14 Thread)

Size	Code
140mm x 600mm x M14	MIXERSPM14/140
160mm x 600mm x M14	MIXERSPM14/160

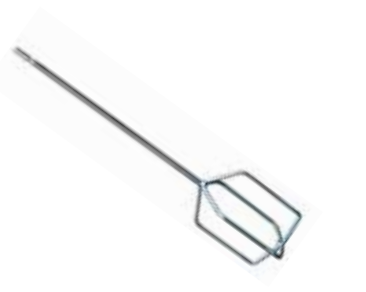

4 Blade Whisk Mixer (Hex Shaft)

Size	Code
120 x 550 x 10mm Hex Shaft	MIXERWHHEX/120



4 Blade Whisk Mixer (M14 Thread)

Size	Code
100mm x 600mm x M14	MIXERWHM14/100
140mm x 600mm x M14	MIXERWHM14/140



HTG-Q7 Concrete Grinder - High Tech Grinding

A commercial grade, single phase multi-purpose grinder, honer and polisher. It has multiple speed settings and boasts one of the largest footprints with a single-phase motor.

Specifications

- Voltage: 220-240V single phase
- Working width: 550mm
- Grinding disc: 230mm x 3
- Rotating speed: 450-1680rpm
- Motor: 5.5HP
- Inverter: 7.5HP
- Weight: 165kg
- Extra weight: 30kg x 1
- Water tank: 20L

Size	Code
-	GRINDQ7



HTG-Q9 Concrete Grinder - High Tech Grinding

A commercial grade, three phase multi-purpose grinder, honer and polisher. It has multiple speed settings with a 750mm wide working width making it suitable for large scale jobs.

Specifications

- Voltage: 380-440V three phase
- Working width: 750mm
- Grinding disc: 260mm x 3
- Rotating speed: 450-1950rpm
- Motor: 15HP
- Inverter: 20HP
- Weight: 340kg
- Extra weight: 40kg x 1
- Water tank: 30L

Size	Code
-	GRINDQ9



HTG-IVC-65 Vacuum - High Tech Grinding

A high velocity vacuum designed for use in conjunction with floor grinding and polishing machines.

Specifications

- Voltage: 220-240V single phase
- Power: 2200W
- Suction: 20Kpa
- Airflow rate: 358m³/H / 211 CFM
- Capacity: 65L
- Weight: 50kg
- Noise: 80dba
- Packing size: 82 x 60 x 110 =0.54CBM

Size	Code
-	GRINDVACVC65



Adiabatic EC2000 HVLP Spray System

A commercial quality HVLP (high volume, low pressure) twin turbine driven spray painting system that is ideal for medium and small scale commercial jobs requiring good speed, great coverage and an excellent finish. The EC2000 does not require a compressor, is light weight, compact and comes with a shoulder carry strap for great versatility and portability. The HVLP system is designed to dramatically reduce overspray and spray clouds producing less waste, easier application and a cleaner environment. It is suitable for liquid paints, spray contact adhesives, latex and many other applications.

Features

- Cloudless - reduces 90% of paint cloud
- Produces hot air for quick drying
- Save up to 40% paint & solvent
- No compressor required
- Environmentally friendly

Technical Specifications

- Two-stage turbine motor
- 600w power
- 240v motor
- C2 type gun with 1 litre cup
- 2.5mt hose (optional 5m)

Size	Code
-	ARG2000



Adiabatic EC3000 HVLP Spray System

A commercial quality HVLP (high volume, low pressure) triple turbine driven spray painting system ideal for medium and small scale commercial jobs requiring good speed, great coverage and an excellent finish. Suitable for continuous use (24hr), it does not require a compressor, is light weight, compact and comes with a shoulder carry strap for great versatility and portability. The HVLP system is designed to dramatically reduce overspray and spray clouds producing less waste, easier application and a cleaner environment. Suitable for liquid paints, spray contact adhesives, latex and many other applications.

Features

- Cloudless - reduces 90% of paint cloud
- Produces hot air for quick drying
- Save up to 40% paint & solvent
- No compressor required
- Environmentally friendly
- Suitable for continuous operation (24hr)

Technical Specifications

- Three-stage turbine motor
- 700w power
- 240v motor
- C5 type gun with 1 litre cup
- 5mt hose (optional 10mt)

Size	Code
-	ARG3000



Megajet Climatic HVLP Spray System

A very powerful industrial performance HVLP (high volume, low pressure) 7x turbine driven spray painting system that is ideal for medium and large scale commercial jobs requiring good speed, great coverage and an excellent finish. The Megajet Climatic is capable of running 4 spray guns at one time, suitable for limitless continuous use, does not require a compressor and has a fitted trolley for easy movability. The Megajet Climatic is designed to dramatically reduce overspray and spray clouds producing less waste, easier application and a cleaner environment, reducing the consumption of paint by up to 40%. It is suitable for liquid paints, spray contact adhesives, latex and many other applications.

Features

- Cloudless - reduces 90% of paint cloud
- Produces hot air for quick drying
- Save up to 40% paint & solvent
- Run up to 4 spray guns at one time
- No compressor required
- Environmentally friendly

Technical Specifications

- Seven-stage turbine motor
- Motor power: 1.5 hp asynchronous
- 220v motor
- Suitable for continuous operation
- C5 type gun with 1 litre cup
- 8mt hose (optional 10mt)

Size	Code
-	ARGMEGAJET



Nitrile Disposable Gloves

Size	Code
Medium	#SAGLBSDNM
Large	#SAGLBSDNL
X Large	#SAGLBSDNXL
XX Large	#SAGLBSDNXXL



Gripmaster Gloves

General purpose work glove.

Size	Code
Small	#SAGLKCS
Medium	#SAGLBKCM
Large	#SAGLBKCL
X Large	#SAGLBKCXL
XX Large	#SAGLBKXXL



Supaflex Gloves

Size	Code
Medium	#SAGLSFM
Large	#SAGLSFL
X Large	#SAGLSFXL
XX Large	#SAGLSFXXL



G-Force Grip Fingerless Gloves

Non-slip grip glove with padded reinforced palms.

Size	Code
Medium	#SAGLFM
Large	#SAGLFL
X Large Black	#SAGLFXL



Texas Safety Glasses

Size	Code
Smoke	#SAGLASSTSM
Clear	#SAGLASSTCL



Denver Smoke Safety Glasses

Medium impact black frame anti-scratch & anti-fog lens.

Size	Code
Non Polarised	#SAGLASSDSM
Polarised	#SAGLASSDPOL



Evolve Safety Glasses

Anti-scratch coated polycarbonate lens that absorbs UV radiation with anti-fog properties.

Size	Code
Clear	#SAGLASSECL
Smoke	#SAGLASSESM
Mirror	#SAGLASSESILV



Ear Plugs

Size	Code
Uncorded 200 Pairs	#SAEARUNC
Corded 100 Pairs	#SAEARCORD



QB2 Supa-Aural Quiet Band

Class 3 / 21dB ear plug. A good alternative to ear muffs.

Size	Code
-	#SAEARQBEP



Ear Muffs

Durable Class 5 / 28dB ear muffs.

Size	Code
-	#SAEARMUFC5



Soft Comifi Knee Pads

Size	Code
-	#SAKPS



Hard Shell Knee Pads

Size	Code
-	#SAKPG



Construction Hard Hat

Vented construction hard hat.

Size	Code
-	#SAHHATWV



Construction Hard Hat Sweat Band

Cotton sweat band.

Size	Code
5 pack	#SAHHSBTA094



Hi-Vis Vest

Size	Code
Medium	#SAHIVSDNOM
Large	#SAHIVSDNOL
X Large	#SAHIVSDNOXL
XX Large	#SAHIVSDNOXXL



Disposable Overalls

All Rounder Coveralls.

Medium	OVERALLDIS/M
Large	OVERALLDIS/LG
X Large	OVERALLDIS/XL



P2 Respirator with valve

3 Pack	#SADMP2WVC3
10 Pack	#SADMP2WV



Barricade Tape

Red & White	#SATBRWT75100
-------------	---------------



Extension Lead Hooks

Attaches to pipe, scaffolding, nails, reo bar etc. Takes 4 power leads and 2 air hoses.

-	#SALEADHOOK
---	-------------



Adheseal

Adheseal Head Office
26 Wolverhampton Street
Stafford
Queensland 4053
Phone: (07) 3356 0000
sales@adheseal.com.au

Adheseal Sunshine Coast
2/18 Kessling Avenue
Kunda Park
Queensland 4556
Phone: (07) 5477 0022
sc@adheseal.com.au

Adhefast

Adhefast Head Office
2/8 Street
Stafford
Queensland 4053
Phone: (07) 3356 0000
sales@adheseal.com.au

www.adheseal.com.au