

Together we're helping
build safer, stronger
structures.

SIMPSON
Strong-Tie

Price Book

2021 – 2022

Effective November 2021

P-SSTAU21

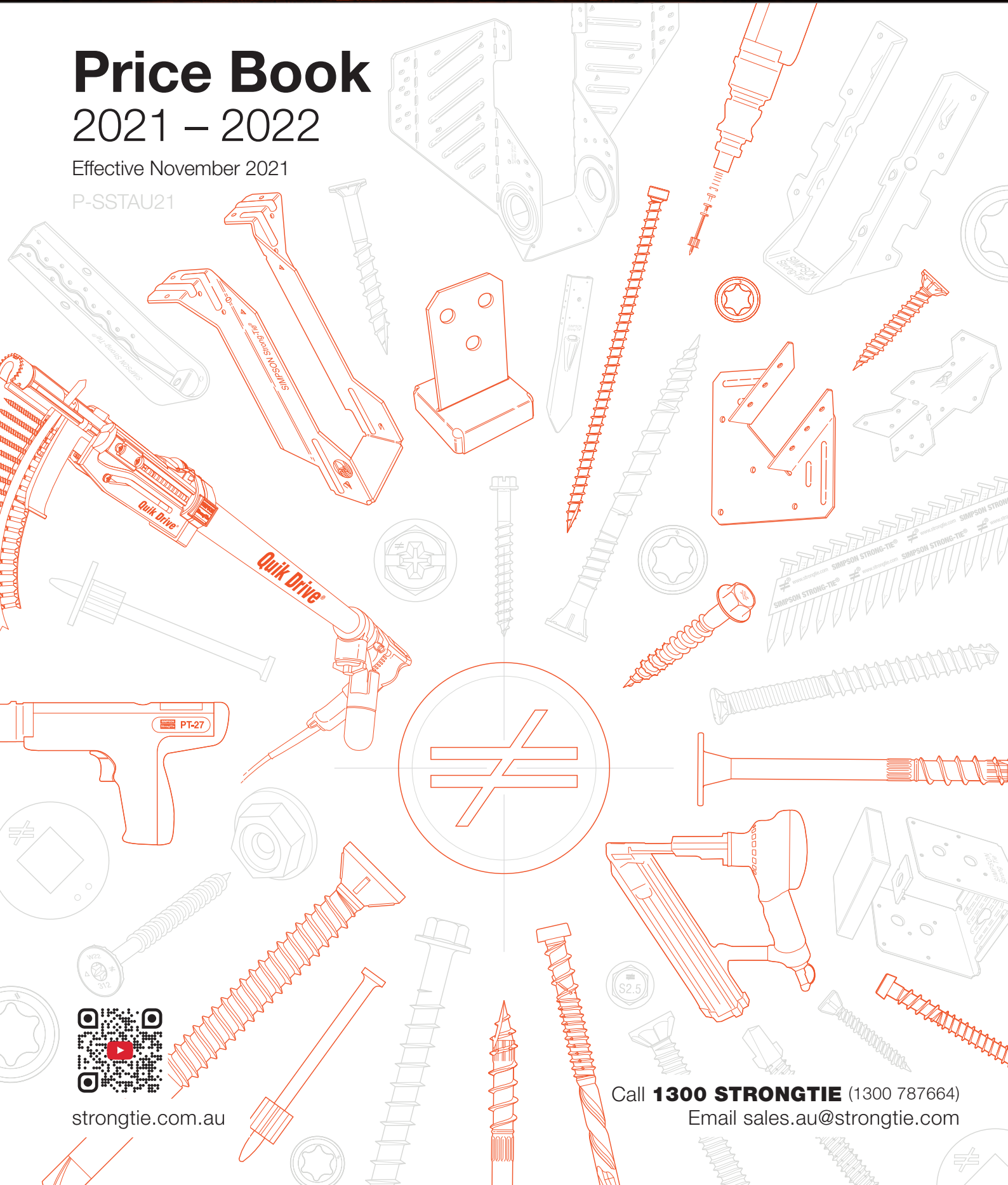

strongtie.com.au

Call **1300 STRONGTIE** (1300 787664)
Email sales.au@strongtie.com

Company Information

For more than 60 years, Simpson Strong-Tie has focused on creating structural products that help people build safer and stronger homes and buildings. A leader in structural systems research and technology, Simpson Strong-Tie is one of the largest suppliers of structural building products in the world.

The Simpson Strong-Tie commitment to product development, engineering, testing and training is evident in the consistent quality and delivery of its products and services.

Simpson Strong-Tie Australia product lines include:

- Fastening systems including Quik Drive® auto-feed screw driving systems
- Simpson Strong-Tie® anchors and fasteners for concrete and masonry
- Repair, Protection, and Strengthening systems
- Structural connectors for timber construction

For more information, call **1300 STRONGTIE** or visit our website **strongtie.com.au**

General Terms and Conditions

1. The prices in this price list are subject to change with at least 30 days notice.
2. **Orders under \$300 (ex GST) will be subject to a \$20 surcharge. This does not apply to Warranty or Backorders.**
3. Delivery of orders are Free Into Store (i.e. delivered to normal place of trade) for all orders over \$300 (ex GST).
4. The Customer will be deemed to have accepted the goods as being in accordance with the order placed unless notified of a claim within 14 days of receipt of the goods.
5. Any and all returns must be approved by Simpson Strong-Tie prior to return. Any return of goods will be subject to a 20% restocking fee.
6. Any goods to be returned must be in good saleable condition and accompanied by an original invoice number.
7. All accounts are Nett 30 days from date of statement.
8. All goods remain the property of Simpson Strong-Tie Australia until payment has been made in full by the Customer.

Frequently Asked Questions

1. **I have a Structural Timber Engineering question.**
Please contact our National Field Engineer.
2. **Is this price book still valid?**
Generally our Price Book is valid for 12 months. Please contact your Simpson Strong-Tie Area Manager for current price book detail.
3. **What is my price?**
This price book has list pricing, your discount needs to be applied to the corresponding purchase quantity. Please contact your Simpson Strong-Tie Area Manager for detail or email sales.au@strongtie.com.
4. **I have seen a Simpson Strong-Tie product on the internet that is not in the Price Book. How can I find out more information?**
Please contact your Simpson Strong-Tie Area Manager.
5. **Need a copy of your invoice?**
Please email accounts.au@strongtie.com with your purchase order number.

Contact Our Team

National Field Engineer

Ben Cox **0401 317 423**
becox@strongtie.com

Area Managers

NSW North

Luke McGlynn..... **0418 577 644**
lmcglynn@strongtie.com

NSW South & ACT

Nathan Zalewski **0408 929 682**
nzalewski@strongtie.com

QLD North

Peter Sheppard **0427 821 327**
psheppard@strongtie.com

QLD South | NT

Mark Daly **0401 485 301**
mdaly@strongtie.com

VIC East | SA

Andrew McGregor..... **0401 485 302**
amcgregor@strongtie.com

VIC West | TAS

Chris Browne..... **0406 678 290**
cbrowne@strongtie.com

WA

Noel Orchard **0401 421 266**
norchard@strongtie.com

Detailed and up-to-date product information can be found on our website.

Click on the product image to take you to its webpage.

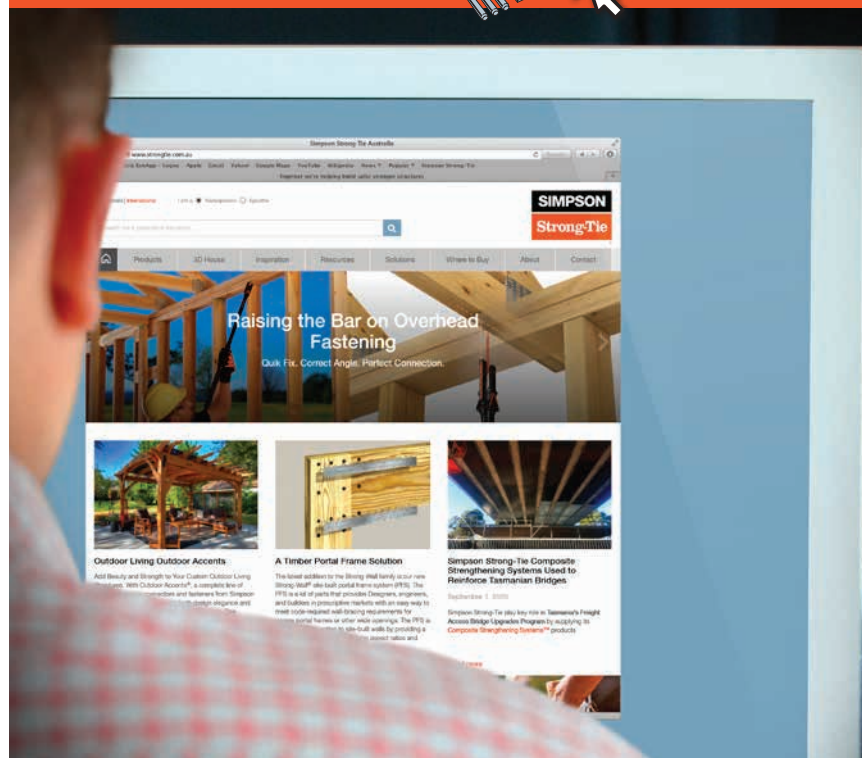

Table of Contents

Connectors for Timber Construction

5 – 9



Tension Ties and Holdowns	6	 Outdoor Structures	8
Post Bases	6	Fixes and Miscellaneous	8
 Joist Hangers for Solid Sawm and Glulam Beam	6 – 7	Strong-Wall® Site-Built Portal Frame System	8
 Bracing and Tie Downs	7	Outdoor Accents®	9



Connectors

Screws and Nails

10 – 13

Collated Connector Nails	10	Deck-Drive™ Premium Deck Screws	12 – 13
Connector Nails	10	Stainless Steel Trim Head Screws	13
 Connector Screws	10	Industrial Grade Driver Bits	13
 Structural Screws	11		



Screws and Nails

Quik Drive® Screw Driving Systems

14 – 15



Quik Drive Attachments	14	 Replacement Parts	15
Quik Drive Systems	14	Driver Bits	15
Adaptors	15	Extension	15
Decking Accessories	15		



Quik Drive®

Collated Screws for the Quik Drive® System

16 – 17

Deck-Drive™ Premium Fasteners	16	 Steel Subfloor Screw	17
Winged Self Drilling Screws	16	 Flooring Screws	17
Cement Sheet / Underlay Screws	17		



Collated Screws

Anchoring Systems for Concrete and Masonry

18 – 19

Anchoring Adhesives and Accessories	18	 Titen Turbo™ Concrete and Masonry Screw Anchor	18
Titen HD® Heavy Duty Screw Anchor	18	Powder-Actuated Fastening Systems	19



Anchoring Systems

Trademark Attribution: Bosch®, E-Coat®, Hitachi®, Makita® and Milwaukee® are registered trademarks of their respective companies.

Alphabetical Index of Products

Symbols

10D5HDG-R 10

A

A35 7
A35SS 7
A35Z 7
ABU44Z 6
ABU66Z 6
APLH45140 9
APLH45240 9
APVA50 9
APVA90 9
APVB90 9
APVDJT45 9
APVDW56-M 9
APVL90 9
APVST90300 9
APVT90 9
AT-HP300BLUE 18

B

BIT2S-2-RC3 13
BIT2S-RC10 15
BIT2SU-2-RC3 13
BIT2SU-RC10 15
BIT3S-RC10 15
BIT3SU-RC10 15
BIT15T-2-RC3 13
BIT20T-2-RC3 13
BIT25T-2-RC3 13
BIT27T-2-RC3 13
BIT30T-2-RC3 13
BIT40T-134-RC3 13
BITTX20-RC10 15
BITTX25-RC10 15
BITTX30-RC10 15

C

CBSDG1SA 16
CBSDG114SA 16
CBSDG158SA 16
CBSDGL3SA 16
CBSDGL158SA 16
CBSDGL214SA 16
CBSDHG158SA 16
CBSDHG214SA 16
CCN64 10
CPT90SS 6
CPT90Z 6
CPT115Z 6
CPT140Z 6
CPT200Z 6

D

DCF622NG2 14
DCSD238BRR250 13
DCSD238GRR250 13
DCSD238RDR250 13
DCSD238TNR250 13
DCU234BRR250 13
DCU234GRR250 13
DCU234RDR250 13
DCU234SS316R250 13
DCU234TNR250 13
DHWG60R250 12
DHWG60SA 16
DSDG50R250 12
DSDG50R1100 12
DSDG50SA 16
DSVT2R250 13
DSVT2S 16
DSVT3S 16
DSVT212R250 13
DSVT212S 16
DT300 18
DTT2Z 6

E

EDT22S 18

F

F07T162TDBBK 13
FPBM44E 8
FPBM75E 8

G

G2HANDLE 15

H

H1.81Z 7
H2.5A 7
H2.5ASS 7
H2.5AZ 7
HIAG2 15
HTT4 6
HTT5 6
HU120/90 7
HU135/63 7
HU140/45 7
HU155/90 7
HU170/45 7
HU170/63 7
HU215/90 7
HU225/63 7
HU240/45 7
HU265/90 7
HU275/63 7
HU285/45 7
HU305/90 7

L

LSSR1.81Z 7
LSSR2.1Z 7
LSSR410Z 7
LUS46/77SS 6
LUS46/77Z 6
LUS46/118SS 6
LUS46/118Z 6
LUS46/166SS 6
LUS46/166Z 6

M

MAA3G2 15
MAA6807G2 15
MDB18512C1 18
MDPL01806 18
MDPL01808 18
MN1-RP10 18
MTHG114SA 17

N

N8D5HDG-R 10
N8DHDG-R 10
N8HDGPT500 10
N8HDGPT4000 10
N10D5HDG-R 10
N10DHDGPT500 10
N10DHDGPT2500 10
N10DHDG-R 10
N10HDGPT500 10
N10HDGPT3000 10

P

P27SL2 19
P27SL3 19
P27SL4 19
P27SL5 19
PDECKNC-RC 15
PDPA-75 19
PDPA-100 19
PDPA-125 19
PDPA-150 19
PDPA-187 19
PDPA-200MG 19
PDPA-250MG 19
PDPA-287MG 19

PDPAWL-100 19
PDPAWL-125 19
PDPAWL-187 19
PDPAWL-200 19
PDPAWL-250 19
PDPAWL-287 19
PFEEDPAWL 15
PFEEDPAWLTL 15
PFS-HKDAU 8
PFS-HKSAU 8
PMANDREL65 15
PMANDREL75 15
PMANDREL75-RC 15
PMANDRELEXTG2 15
PPSD1050SA 17
PPSDQ134S1016 17
PRO250G2DC2KA 14
PRO250G2DC2KA-S 14
PRO250G2M25KA 14
PT-27 19
PW18EXT 11
PWKIT25T 11
PWKIT40T 11

Q

QDEXTG2 15
QDHSD60 14
QDHSD75 14
QDPRO250G2A 14
QDPRO250G2IK 14
QDPRO300SG2A 14
QUIKSTIK 11

S

S07225FTBBK 13
SAE200/46/2 6
SAE200/46/2PB 9
SAE250/46/2 6
SAE250/46/2PB 9
SAE500/46/2 6
SAE600/47/2 6
SD38DBBR50 9
SD9112R100 10
SD9112SS-R100 10
SD9212R100-R 10
SD9212SS-R100 10
SD10112R100 10
SD10212R100-R 10
SDE340/30 7
SDE440/30 7
SDPW14312MB 11
SDPW14312-R50 11
SDPW14500MB 11
SDPW14500-R50 11
SDPW19600MB 11
SDPW19600-R50 11
SDS25112-R25 10
SDS25112SS-R25 10
SDS25212-R25 10
SDS25212SS-R25 10
SDS25300-R25 10
SDS25300SS-R25 10
SDWC15450-KT 11
SDWC15600-KT 11
SDWS90DBB-R50 9
SDWS140DBB-R50 9
SDWS22300DB 11
SDWS22300DB-R50 11
SDWS22400DB 11
SDWS22400DB-R50 11
SDWS22500DB 11
SDWS22500DB-R50 11
SDWS22600DB 11
SDWS22600DB-R50 11
SDWS22800DB 11
SDWS22800DB-R50 11
SDWS221000DB 11
SDWS221000DB-R50 11
SET-XP650-AU 18
SSA10D5 10

SSA10DD 10
SSBFHSD2R250 12
SSBFHSD2SA 16
SSDHSD50R250 12
SSDHSD50TSA 16
SSDHSD60R250 12
SSDHSD60S 16
SSDHW60R250 12
SSDHW60SA 16
SSDSD50R250 12
SSDSD50R1100 12
SSDSD50SA 16
SSDSD65R250 12
SSDSD65R1100 12
SSDSD65SA 16
SSDSD1475R150 12
SSDSD1475R400 12
SSDSD1475SA 16
SSDSD14100R150 12
SSDSD14100R400 12
SSNA8D 10
SSNA8D5 10
SSNA10D 10
SSNA10D5 10
STN22M-R8 9

T

T9A150MCN 10
T9A250MCN 10
T10A150MCN 10
T08125WPR500 12
T08162WPR250 12
T10200WPR250 12
T10200WPR1100 12
T10250WPR250 12
T10250WPR1100 12
T10300WPR250 12
T14300WPR150 12
T14300WPR400 12
T14400WPR150 12
T14400WPR400 12
T14600WPR100 12
TA9Z-R 8
TBG1445SA 16
TBG1460S 16
TBG1475S 16
THD10060MG 18
THD10100MG 18
THD12075MG 18
THD12110MG 18
THD12130MG 18
THD12150MG 18
THD16130MG 18
THD16150MG 18
THD20150MG 18
THD20170MG 18
TNT25114H 18
TNT25134H 18
TNT25134TF 18
TNT25214H 18
TNT25214TF 18
TNT25234H 18
TNT25234TF 18
TNT25314H 18
TNT25314TF 18
TNT25334H 18
TNT25334TF 18
TNT25400H 18
TNT25400TF 18
TP15 8

W

WSC114SA 17
WSCBGA158SA 17
WSCBGHLA114SA 17
WSV45SA 17
WSV50-2500 17
WSV50SA 17
WSV64SA 17
WSV75SA 17

Connectors for Timber Construction

Connectors

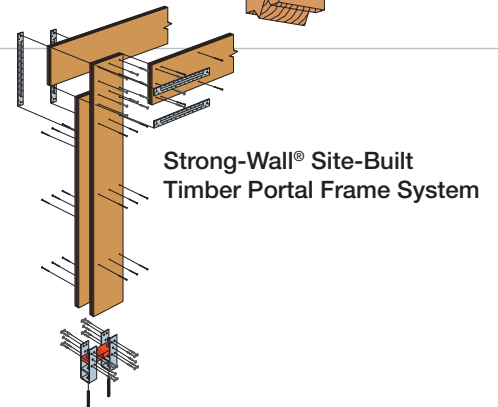
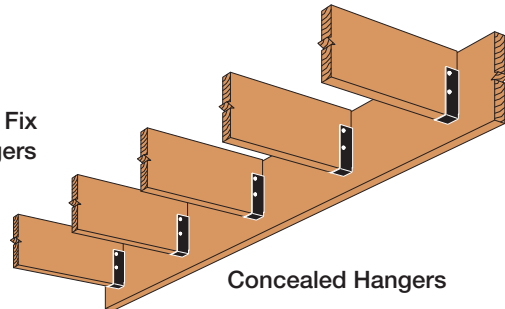
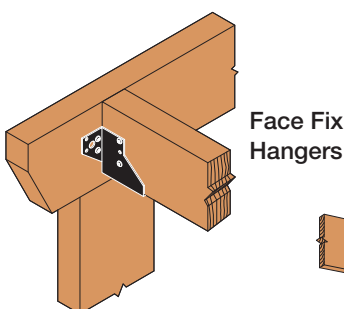
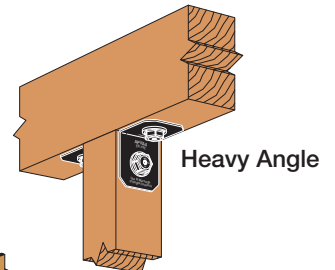
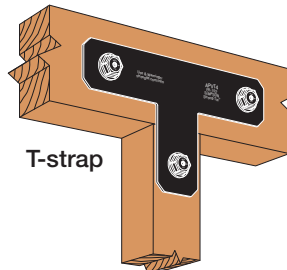
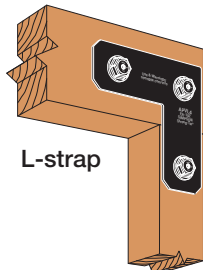
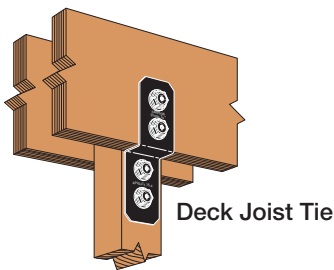
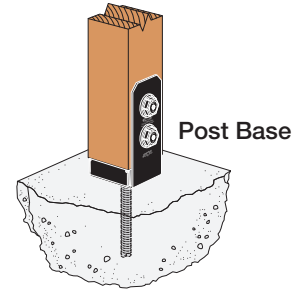
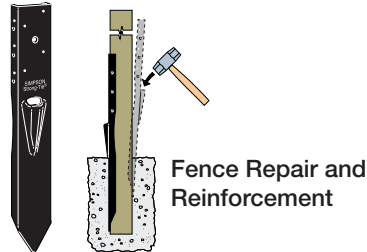
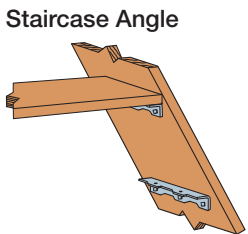
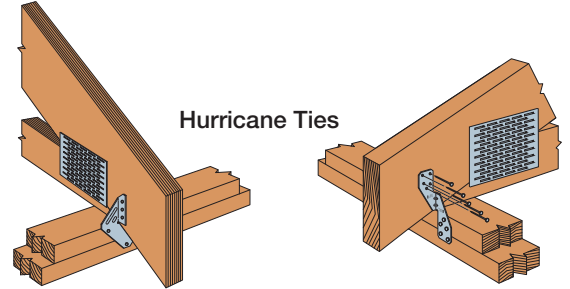
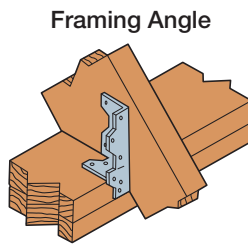
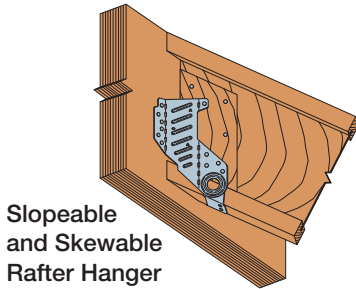
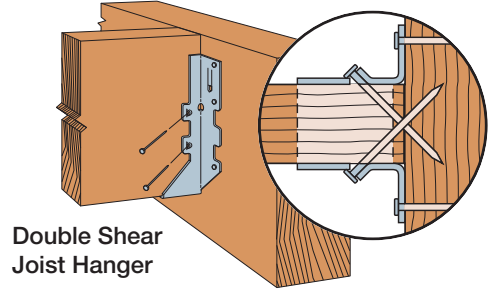
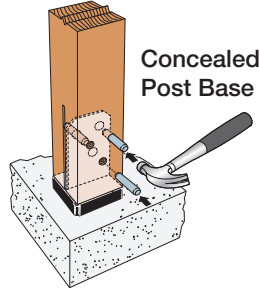
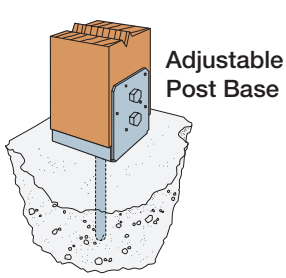
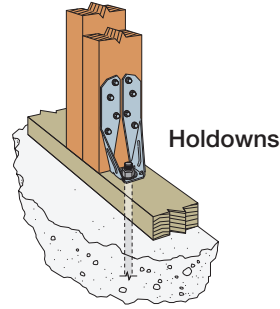
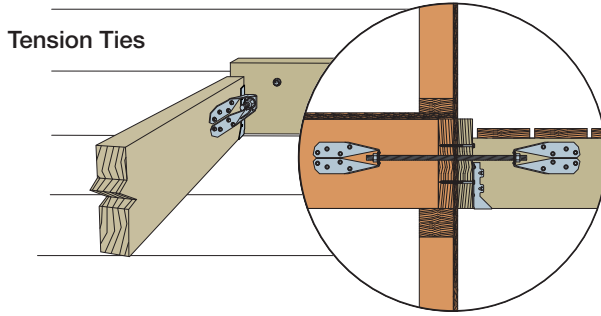

P-SSTAL21 © 2021 SIMPSON STRONG-TIE COMPANY INC.

Connectors for Timber Construction

Connectors

Tension Ties and Holdowns

Tension Tie

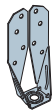
Image	Model No.	Description	Thickness (mm)	Finish	Barcode	Ctn Qty	Price/ea
	DTT2Z	85 x 175 x 40 mm Includes washer and 8 – SDS 6.4 x 38 mm screws	2	ZMAX®	707392528203	20	\$7.60
	HTT4	60 x 315 x 50 mm	3.1	Z275 Galvanised	707392894605	16	\$11.00
	HTT5	64 x 406 x 50 mm			707392617907	10	\$14.00

Post Bases

Adjustable Post Base

	ABU44Z	Suits 90 mm sq. post	Base 1.6 Strap 2.7	ZMAX®	044315936401	12	\$11.00
	ABU66Z	Suits 140 mm sq. post	Base 2.7 Strap 3.5	ZMAX®	044315119606	10	\$20.80

Concealed Post Base

	CPT90Z	Suits 90 mm sq. post	Base 2.7 Knife Plate 3.5	ZMAX®	707392420934	10	\$16.00
	CPT90SS		Base 2.7 Knife Plate 3.5	316L Stainless Steel	707392210979	10	\$76.60
	CPT115Z	Suits 115 mm sq. post			707392014379	10	\$19.00
	CPT140Z	Suits 140 mm sq. post	Base 2.7 Knife Plate 3.5	ZMAX®	707392342595	8	\$21.00
	CPT200Z	Suits 190 mm sq. post			707392505327	6	\$46.50

Image	Model No.	Description			Bracket Seat (mm)	Thickness (mm)	Finish	Barcode	Ctn Qty	Price/ea
		Suitable Timber Range (mm)								

Joist Hangers for Solid Sawn and Glulam Beam

Double Shear Joist Hanger

	45 mm (w) Timber										
	LUS46/77Z	90 – 130 mm (h)	77	46	45	1.2	ZMAX®	707392503156	50	\$1.60	
	LUS46/118Z	120 – 190 mm (h)	118					707392422525	50	\$1.95	
	LUS46/166Z	175 – 280 mm (h)	166					707392842149	50	\$2.40	
	LUS46/77SS	90 – 130 mm (h)	77					316L Stainless Steel	707392422068	25	\$5.50
	LUS46/118SS	120 – 190 mm (h)	118						707392604594	25	\$7.60
	LUS46/166SS	175 – 280 mm (h)	166						707392769026	25	\$8.60

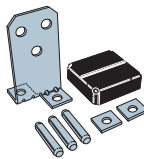
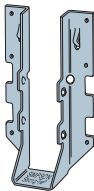
Face Fix Joist Hanger

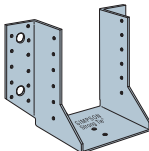
	45 mm (w) Timber										
	SAE200/46/2	90 – 120 mm (h)	77	46	84	2	Z275 Galvanised	3523140470405	50	\$1.75	
	SAE250/46/2	115 – 150 mm (h)	102					3523140461700	50	\$2.00	
	SAE500/46/2	240 – 340 mm (h)	227					3523140752204	25	\$4.50	
	SAE600/47/2	292 – 462 mm (h)	276					47	88	5015364821456	25

P-SSTAUL21 © 2021 SIMPSON STRONG-TIE COMPANY INC.

Connectors for Timber Construction

Connectors

Joist Hangers for Solid Sawn and Glulam Beam (continued)

Face Fix Joist Hanger

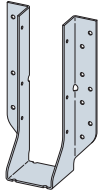

45 mm (w) Timber

NEW	Model No.	Description	Bracket Seat			Thickness (mm)	Finish	Barcode	Ctn Qty	Price/ea
			H	W	B					
	HU140/45	140 – 205 mm (h)	137	46	64	2	Z275 Galvanised	707392017431	25	\$2.50
	HU170/45	170 – 255 mm (h)	170					707392017448	25	\$2.90
	HU240/45	240 – 355 mm (h)	237					707392017455	25	\$3.50
	HU285/45	285 – 420 mm (h)	281					707392017462	25	\$4.35

63 mm (w) Timber

	HU135/63	135 – 190 mm (h)	133	65	67	2	Z275 Galvanised	707392017479	50	\$6.35
	HU170/63	170 – 250 mm (h)	167					707392017486	25	\$6.50
	HU225/63	225 – 335 mm (h)	225					707392017837	25	\$6.70
	HU275/63	275 – 410 mm (h)	275					707392017493	25	\$7.00

90 mm (w) Timber

	HU120/90	120 – 180 mm (h)	120	90	67	2	Z275 Galvanised	707392017509	50	\$4.20
	HU155/90	160 – 235 mm (h)	155					707392017516	25	\$4.60
	HU215/90	215 – 315 mm (h)	213					707392017523	25	\$5.40
	HU265/90	265 – 390 mm (h)	263					707392017530	25	\$7.60
	HU305/90	305 – 450 mm (h)	302					707392017844	25	\$10.30

Split Joist Hangers for Solid Sawn and Glulam Beam

Price per set (left and right)

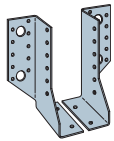

	SDE340/30	60 – 120 (w) x 140 – 207 mm (h)	140	30 (each leg)	84	2	Z275 Galvanised	3523140454962	25	\$16.20
	SDE440/30	60 – 120 (w) x 190 – 282 mm (h)	190					3523140632643	25	\$16.20

Slopeable and Skewable Rafter Hanger for Solid Sawn, Glulam Beam and Engineered Wood

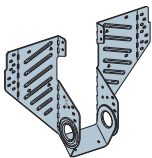

	LSSR1.81Z	45 (w) x 240 – 360 mm (h)	227	46	—	1.3	ZMAX®	707392003755	25	\$12.50
	LSSR2.1Z	50-53 (w) x 240 – 360 mm (h)		54		1.3		707392003762	25	\$13.50
	LSSR410Z	90 (w) x 240 – 360 mm (h)		92		1.6		707392003939	25	\$16.20

Bracing and Tie Downs

Framing Angle



	A35	35 x 35 x 115 mm Bending slot allows field bend for 2 and 3-way ties	1.5	Z275 Galvanised	044315046001	100	\$0.55
	NEW A35Z			ZMAX®	044315393600	100	\$0.60
	A35SS			316L Stainless Steel	044315178702	25	\$2.70

Hurricane Ties

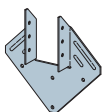

	H1.81Z	135 x 135 x 21 mm Suits 45 mm timber	1.3	ZMAX®	707392000433	50	\$2.20
	H2.5A	35 x 35 x 150 mm		Z275 Galvanised	707392398806	100	\$0.55



	NEW H2.5AZ	35 x 35 x 150 mm	ZMAX®	044315780608	100	\$0.60
	H2.5ASS		316L Stainless Steel	707392538202	100	\$2.00

Connectors for Timber Construction

Connectors

Image	Model No.	Description Suitable Timber Range (mm)	Bracket Seat (mm)			Thickness (mm)	Finish	Barcode	Ctn Qty	Price/ea
			H	W	B					

Outdoor Structures

Staircase Angle

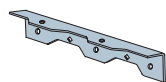

TA9Z-R

40 x 40 x 210 mm

2.7

ZMAX®

707392459750

20

\$2.45

E-Z Mender™ Timber Fence Post Repairer



FPBM44E

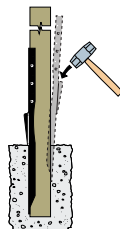

Repair or reinforcement of rotted or damaged 90 mm timber fence posts

2.7

Black Powder Coating

707392248705

6

\$18.50



FPBM75E

Repair or reinforcement of rotted or damaged 75 mm timber fence posts

707392016618

6

\$18.50

Fixes and Miscellaneous

Tie Plate

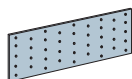

TP15

45 x 125 mm – 13 holes

1

Z275 Galvanised

044315831003

150

\$0.55

Strong-Wall® Site-Built Portal Frame System



PFS-HKSAU

Single-Wall Portal Frame Kit Includes:

(2) Holddown assemblies, (2) Composite standoff bases, (5) Moment connection straps, (1) Adjustable post base (ABW44Z), (33) SDW22300 truss-ply screws, (8) SD9112 Connector screws, (1) 6-lobe T40 driver bit, (1) Installation instructions.

707392009252

1

\$270.00



PFS-HKDAU

Double-Wall Portal Frame Kit Includes:

(4) Holddown assemblies, (4) Composite standoff bases, (8) Moment connection straps, (66) SDW22300 truss-ply screws, (1) 6-lobe T40 driver bit, (1) Installation instructions.

707392009269

1

\$324.00









Strong-Wall® Site-Built Portal Frame System











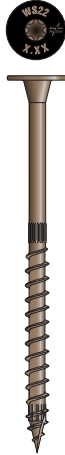







Connectors for Timber Construction

Image	Model No.	Description	Thickness (mm)	Finish	Barcode	Ctn Qty	Price/ea	
Outdoor Accents®								
Post Base								
	APVB90	Suits 90 x 90 mm timber	Base 1.6 Strap 2.7	ZMAX® with Black Powder Coating	707392009146	8	\$26.00	
Deck Joist Tie								
	APVDJT45	Suits 45 mm wide joists	2.7	ZMAX® with Black Powder Coating	707392009160	12	\$9.80	
Strap Ties								
	APVL90	L-Strap Tie — Suits min. 90 mm timber	2.7	ZMAX® with Black Powder Coating	707392009122	8	\$11.90	
	APVT90	T-Strap Tie — Suits min. 90 mm timber			707392009139	8	\$14.60	
	APVST90300	Flat-Strap Tie — Suits min. 90 mm timber			707392009177	8	\$8.80	
Angles								
	APVA90	Heavy Angle	2.7	ZMAX® with Black Powder Coating	707392009115	12	\$6.40	
	APVA50	Light Angle	2		707392009108	45	\$3.80	
Decorative Plate								
	APVDW56-M	Decorative Plate (Fastener is SDWS90DBB-R50 or SDWS140DBB-R50, inserted through an STN22M-R8 washer.)	2.7	ZMAX® with Black Powder Coating	707392009153	24	\$4.90	
Concealed Hangers								
	APLH45140	Suits 45 mm (w) x 140 – 240 mm (h)	2	ZMAX® with Black Powder Coating	707392009184	24	\$10.30	
	APLH45240	Suits 45 mm (w) x 200 – 320 mm (h)			707392009191	12	\$12.50	
Face Fix Hangers								
	SAE200/46/2PB	Suits 45 mm (w) x 90 – 120 mm (h)	2	ZMAX® with Black Powder Coating	3523140001821	8	\$5.80	
	SAE250/46/2PB	Suits 45 mm (w) x 115 – 150 mm (h)			3523140001838	12	\$6.40	
Image	Model No.	Description	Box Qty	Thickness (mm)	Finish	Barcode	Box/Ctn	Price/Box
Connector Screw Supplied with driver bit								
	SD38DBBR50	10g x 38 mm Connector Screw , ¼" Hex head, Patented serrated threads, Sharp point	50	4 mm shank	Double-Barrier Coating	707392009245	5	\$18.90
SDWS Structural Timber Screw Supplied with driver bit								
	SDWS90DBB-R50	90 mm Ribbed large washer head, Patented SawTooth™ point, T-40 6-lobe drive	50	5.6 mm shank	Double-Barrier Coating	707392009214	6	\$46.50
	SDWS140DBB-R50	140 mm				707392009221	6	\$68.00
Hex-Head Washer								
	STN22M-R8	Hex-Head Washer	8	38 mm diameter	Quik Guard® Black with Black Powder Coating	707392009238	10	\$37.80

Screws and Nails

Image	Model No.	Description	Barcode	Box Qty	Price/Box	Ctn Qty			
Collated Connector Nails									
Pneumatic Collated Connector Nailer									
	CCN64	Accepts 38 mm and 64 mm length, 3.3 mm or 3.8 mm shank, Full round head, 33° paper collated nails	707392710929	1	\$421.00	2			
Strong-Drive® SCN Smooth-Shank Collated Connector Nail									
	N8HDGPT500	38 mm x 3.32 mm	33° Collation, 22 nails per strip, Full round-smooth head, Smooth Shank, Diamond point	Hot-Dip Galvanised	707392215301	500	\$31.80	4	
	N8HDGPT4000				8	707392650317	4000	\$232.20	—
	N10HDGPT500	38 mm x 3.75 mm			707392703808	500	\$37.80	4	
	N10HDGPT3000				10	707392457282	3000	\$189.00	—
	N10DHDGPT500	64 mm x 3.75 mm			707392443100	500	\$57.20	4	
	N10DHDGPT2500				10	707392784869	2500	\$297.00	—
Strong-Drive® SCNR Ring-Shank Collated Connector Nail									
	T10A150MCN	38 mm x 3.32 mm	33° Collation, 22 nails per strip, Full round-smooth head, Annular-Ring Shank, Diamond point	316 Stainless Steel	707392647232	1500	\$300.00	4	
	T9A150MCN	38 mm x 3.75 mm			All	744039022335	1500	\$307.80	4
	T9A250MCN	64 mm x 3.75 mm			Sizes	744039600823	1000	\$310.00	4
Connector Nails									
Strong-Drive® SCN Smooth-Shank Connector Nail									
	N8DHDG-R	38 mm x 3.32 mm	Full round-smooth head, Smooth Shank, Diamond point	Hot-Dip Galvanised	707392190677	150	\$8.65	12	
	N8D5HDG-R				8	707392637226	750	\$31.30	4
	N10DHDG-R	38 mm x 3.75 mm			707392841630	120	\$9.30	12	
	N10D5HDG-R				10	707392710257	600	\$32.50	4
	10D5HDG-R	75 mm x 3.75 mm			707392478737	250	\$44.80	4	
Strong-Drive® SCNR Ring-Shank Connector Nail									
	SSNA8D	38 mm x 3.32 mm	Full round-smooth head, Annular-Ring Shank, Diamond point	316 Stainless Steel	707392915607	150	\$29.20	10	
	SSNA8D5				8	707392110200	750	\$112.30	6
	SSNA10D	38 mm x 3.75 mm			707392353003	120	\$30.80	10	
	SSNA10D5				All	707392499404	600	\$113.40	6
	SSA10DD	75 mm x 3.75 mm			707392400004	50	\$36.80	10	
	SSA10D5				Sizes	707392819509	250	\$107.00	6
Connector Screws									
Strong-Drive® SD Connector Screw									
	SD9112R100	#9 x 38 mm	1/4" Hex head Patented serrated threads, Sharp point	316 Stainless Steel	Mechanically	707392977001	100	\$17.80	10
	SD9212R100-R	#9 x 64 mm			Galvanised	707392884446	100	\$22.75	4
	NEW SD9112SS-R100	#9 x 38 mm			707392015239	100	\$30.50	10	
	NEW SD9212SS-R100	#9 x 64 mm			707392015208	100	\$38.00	6	
	SD10112R100	#10 x 38 mm			Mechanically	707392461203	100	\$18.25	10
	SD10212R100-R	#10 x 64 mm			Galvanised	707392450290	100	\$23.00	4
	Strong-Drive® SDS Heavy-Duty Connector Screw								
	SDS25112-R25	6.4 mm x 38 mm	3/8" Hex Head Serrated threads Type 17	316 Stainless Steel	Double-Barrier Coating	707392962502	25	\$10.20	—
	SDS25212-R25	6.4 mm x 64 mm				707392325703	25	\$13.20	12
	SDS25300-R25	6.4 mm x 76 mm				707392800606	25	\$15.70	—
	SDS25112SS-R25	6.4 mm x 38 mm				707392322405	25	\$28.20	—
	SDS25212SS-R25	6.4 mm x 64 mm				707392624103	25	\$38.80	10
	SDS25300SS-R25	6.4 mm x 76 mm				707392459408	25	\$64.80	—



Screws and Nails

Image	Model No.	Description	Barcode	Box Qty	Price/Box	Ctn Qty	
Structural Screws							
Strong-Drive® SDWS TIMBER Screw		Suitable for Treated Timber	Supplied with driver bit				
	50 Pack						
	SDWS22300DB-R50	76 mm		746056005186	50	\$40.20	
	SDWS22400DB-R50	102 mm		746056005216	50	\$51.30	
	SDWS22500DB-R50	127 mm	Ribbed large washer head Patented SawTooth™ point Double-Barrier Coating. T-40 6-lobe drive	746056005247	50	\$57.00	
	SDWS22600DB-R50	152 mm		746056005278	50	\$73.50	
	SDWS22800DB-R50	203 mm		746056005308	50	\$104.50	
	SDWS221000DB-R50	254 mm		746056005339	50	\$128.00	
	Bulk Pack						
	SDWS22300DB	76 mm			746056005193	950	\$570.80
	SDWS22400DB	102 mm		746056005223	600	\$430.90	
	SDWS22500DB	127 mm	Ribbed large washer head Patented SawTooth™ point Double-Barrier Coating. T-40 6-lobe drive	746056005254	600	\$548.60	
	SDWS22600DB	152 mm		746056005285	500	\$608.00	
SDWS22800DB	203 mm	746056005322		400	\$761.50		
SDWS221000DB	254 mm	746056005346		250	\$594.00		
Strong-Drive® SDWC TRUSS Screw					Supplied with installation guide and driver bit		
	SDWC15450-KT	3.9 x 114 mm E-Coat®	Cap-style head, Type 17, T30 6-lobe drive	746056235507	50	\$37.50	
	SDWC15600-KT	3.9 x 152 mm Clear Zinc with Orange Topcoat		746056548027		\$47.50	
Installation Tool for Strong-Drive® SDWC TRUSS Screw							
	QUIKSTIK	Rafter and Truss Fastening System (for use with the Strong-Drive® SDWC TRUSS Screw) Includes sturdy carry case	707392001256	1	\$390.00	2	
Strong-Drive® SDPW Deflector Screw					Supplied with offset driver bit and 3/8" predrill bit		
	 SDPW14312-R50	Blue 3.5 x 89mm Strong-Drive® SDPW Deflector Screw	707392014447	50	\$96.00	6	
	 SDPW14312MB		707392014478	500	\$658.80	—	
	 SDPW14500-R50	Orange 3.5 x 127mm Strong-Drive® SDPW Deflector Screw	707392014454	50	\$106.90	6	
	 SDPW14500MB		707392014485	500	\$691.20	—	
	 SDPW19600-R50	Grey 5.0 x 152mm Strong-Drive® SDPW Deflector Screw	707392014461	50	\$137.20	6	
	 SDPW19600MB		707392014492	400	\$777.60	—	
Strong-Drive® SDPW Accessories							
	 PWKIT25T	T25 Bit Kit: 1 x Quick Release Predrill Bit (3/8" (9.5 mm) x 5" (127 mm)), 2 x T25 Offset Driver Bits	707392014508	12	\$35.60	12	
	 PWKIT40T	T40 Bit Kit: 1 x Quick Release Predrill Bit (3/8" (9.5 mm) x 5" (127 mm)), 2 x T40 Offset Driver Bits	707392014515	12	\$35.60	12	
	 PW18EXT	1 x Extension 450 mm	707392014522	15	\$33.50	15	

P-SSTAU21 © 2021 SIMPSON STRONG-TIE COMPANY INC.

Screws and Nails

Screws and Nails

Image	Model No.	Description	Barcode	Box Qty	Price/Box	Ctn Qty		
Deck-Drive™ Premium Fasteners								
Supplied with driver bit								
Timber to Steel								
BFHSD BI-METAL Screw								
	SSBFHSD2R250	(10g) 4.8 x 50 mm	Ribbed flat head, 316 Stainless Steel Bi-Metal, #2 Sq. Drive	707392426738	250	\$138.60	6	
Hardwood								
DSD HARDWOOD Screw								
	DSDG50R250	(12g) 5.5 x 50 mm	Flat countersinking head, Hardwood Drill point, Quikguard® Grey. T-25 6-lobe drive	707392007715	250	\$37.80	6	
	DSDG50R1100			707392007722	1100	\$140.50	—	
	SSDSD50R250	(12g) 5.5 x 50 mm	Flat countersinking head, Hardwood Drill point, 316 Stainless Steel, T-25 6-lobe drive	707392007685	250	\$63.70	6	
	SSDSD50R1100			707392007692	1100	\$237.60	—	
	SSDSD65R250	(12g) 5.5 x 65 mm	Flat countersinking head, Hardwood Drill point, 316 Stainless Steel, T-25 6-lobe drive	707392007654	250	\$74.50	6	
	SSDSD65R1100			707392007661	1100	\$318.60	—	
	SSDSD1475R150	(14g) 6.5 x 75 mm	Flat countersinking head, Hardwood Drill point, 316 Stainless Steel, T-30 6-lobe drive	707392010111	150	\$118.80	3	
	SSDSD1475R400			707392010128	400	\$270.00	—	
	SSDSD14100R150	(14g) 6.5 x 100 mm	Flat countersinking head, Hardwood Drill point, 316 Stainless Steel, T-30 6-lobe drive	707392010135	150	\$129.60	3	
	SSDSD14100R400			707392010142	400	\$318.60	—	
DHSD HARDWOOD Screw								
	SSDHSD50R250	(12g) 5.5 x 50 mm	Raised countersinking head, Hardwood Drill point, 305 Stainless Steel, #2 Sq. drive	707392236825	250	\$55.00	6	
	SSDHSD60R250	(12g) 5.5 x 60 mm		707392930198	250	\$60.50	6	
DHW HARDWOOD Screw								
	DHWG60R250	(10g) 4.8 x 60 mm	Compact head, Winged, Hardwood drill point	Class 3 Galvanised, #2 Undersize sq. drive	707392969839	250	\$35.50	6
	SSDHW60R250				707392441267	250	\$65.00	6
Softwood								
DWP WOOD SS Screw								
	T08125WPR500	(8g) 4.2 x 32 mm	Flat head w/nibs, Box threads, Sharp point, 316 Stainless Steel	T-20 6-lobe drive	707392001409	500	\$52.60	6
	T08162WPR250	(8g) 4.2 x 42 mm			707392001416	250	\$63.70	6
	T10200WPR250	(10g) 4.8 x 50 mm			707392001423	250	\$42.00	6
	T10200WPR1100		707392001485	1100	\$172.00	—		
	T10250WPR250	(10g) 4.8 x 65 mm	Flat head w/nibs, Box threads, Sharp point, 316 Stainless Steel	T-25 6-lobe drive	707392001430	250	\$48.60	6
	T10250WPR1100				707392001492	1100	\$188.00	—
	T10300WPR250	(10g) 4.8 x 75 mm	Flat head w/nibs, Box threads, Sharp point, 316 Stainless Steel	T-25 6-lobe drive	707392001447	250	\$59.50	6
	T14300WPR150	(14g) 6.5 x 75 mm			707392010159	150	\$74.50	3
	T14300WPR400		(14g) 6.5 x 75 mm	Flat head w/nibs, Box threads, Sharp point, 316 Stainless Steel	T-25 6-lobe drive	707392010166	400	\$189.00
	T14400WPR150	(14g) 6.5 x 100 mm				707392010173	150	\$81.00
	T14400WPR400		(14g) 6.5 x 100 mm	Flat head w/nibs, Box threads, Sharp point, 316 Stainless Steel	T-27 6-lobe drive	707392010180	400	\$215.00
	T14600WPR100	(14g) 6.5 x 150 mm				707392001478	100	\$125.00

P-SSTAL21 © 2021 SIMPSON STRONG-TIE COMPANY INC.











Screws and Nails

Image	Model No.	Description	Barcode	Box Qty	Price/Box	Ctn Qty		
Deck-Drive™ Premium Fasteners (continued)			Supplied with driver bit					
Softwood (continued)								
DSV SOFTWOOD Screw								
	DSVT2R250	(10g) 4.8 x 50 mm	Rimmed flat head with nibs, Variable thread design, High-low tip, Quikguard® Tan. T-25 6-lobe drive	707392433088	250	\$34.50	6	
	DSVT212R250	(10g) 4.8 x 65 mm		707392786337	250	\$38.80		
Composite to Timber								
DCU COMPOSITE Screw								
	DCU234BRR250	(10g) 4.8 x 70 mm	Brown	Cap head, Tri-lobe threads, Double-cut point, Quikguard® Colour Finish, T-20 6-lobe drive	707392348542	250	\$49.80	6
	DCU234GRR250		Grey		707392104254	250	\$49.80	
	DCU234RDR250		Red		707392276159	250	\$49.80	
	DCU234TNR250		Tan		707392383529	250	\$49.80	
	DCU234SS316R250		—		316 Stainless Steel	707392117551	250	
Composite to Steel								
DCSD COMPOSITE Screw								
	DCSD238BRR250	(10g) 4.8 x 60 mm	Brown	Cap head #2 Drill point, Quikguard® Colour Finish, #2 Undersize sq. drive	707392801863	250	\$57.50	6
	DCSD238GRR250		Grey		707392951742	250	\$57.50	
	DCSD238RDR250		Red		707392504986	250	\$57.50	
	DCSD238TNR250		Tan		707392746041	250	\$57.50	
305 Stainless Steel Trim Head Type 17 Screws			Supplied with driver bit					
 <i>(Black painted head)</i>	S07225FTBBK	7g x 55 mm	Trim Head, Type 17, 305 Stainless Steel, T-15 6-lobe drive	707392358749	1750	\$353.50	—	
410 Stainless Steel Trim Head Self Drilling Screws			Driver bit NOT included					
 <i>(Black painted head)</i>	F07T162TDBBK	7g x 42 mm	Trim Head, 19 TPI, #3 Drill Point, 410 Stainless Steel, #1 Sq. Drive	707392534778	5000	\$741.00	—	
Industrial Grade Driver Bits								
	BIT2SU-2-RC3	#2 Undersize sq. drive	50 mm (2") long	707392586340		\$12.40	10	
	BIT2S-2-RC3	#2 Square drive		707392836742		\$12.40		
	BIT15T-2-RC3	T-15 6-lobe drive		707392648147		\$12.40		
	BIT20T-2-RC3	T-20 6-lobe drive		707392270232	3	\$12.40		
	BIT25T-2-RC3	T-25 6-lobe drive		707392547648		\$12.40		
	BIT27T-2-RC3	T-27 6-lobe drive		707392495796		\$12.40		
	BIT30T-2-RC3	T-30 6-lobe drive		707392684213		\$12.40		
	BIT40T-134-RC3	T-40 6-lobe drive		45 mm (1¾") long	746056190523			\$20.00

P-SSTAU21 © 2021 SIMPSON STRONG-TIE COMPANY INC.

Screws and Nails

Quik Drive® Screw Driving Systems

Image	Model No.	Description	Barcode	Pack Qty	Price/Pack
Quik Drive Attachments					
	QDPRO200SG2	PRO200 Attachment for 8 – 12g and 25 – 50 mm screws. Includes carry case (Ideal for SHORTER screws)	Flooring, Decking, Cladding	746056002406	1 \$358.50
	QDPRO250G2A	PRO250 Attachment for 8 – 12g and 40 – 65 mm screws. Includes carry case	Flooring, Decking, Cladding	746056375555	1 \$358.50
	QDPRO300SG2A	PRO300 Attachment for 8 – 12g and 40 – 75 mm screws. Includes carry case (Ideal for LONGER screws)	Flooring, Decking, Cladding	707392925255	1 \$358.50
	QDHSD60	HSD60 Attachment for 14g and 45 – 60 mm screws. Includes carry case	Heavy Duty	746056020684	1 \$418.00
	QDHSD75	HSD75 Attachment for 14g and 45 – 75 mm screws. Includes carry case	Heavy Duty	746056020691	1 \$442.00
*Screwgun adaptors required and sold separately.					
Quik Drive Systems					
PRO250 system is ideal for, but not limited to, underlay, subfloor, sheathing and decking applications					
	QDPRO250G2IK *	PRO250 System for 8 – 12g and 40 – 65 mm screws. Attachment, Extension (QDXTG2), Adaptors (MAA3G2, HIAG2), Rugged Tool Case		746056018834	1 \$664.00
	PRO250G2M25KA	PRO250 System, includes Makita ® FS2300 Screwgun Fitted with MAA3G2 adaptor		746056006855	1 \$1,065.00
	PRO250G2DC2KA	PRO250 System, includes DeWalt ® DCF622 screw gun fitted with adaptor, Multivolt charger, 2 x 18V 5.0Ah batteries		707392013570	1 \$1,350.00
	PRO250G2DC2KA-S	PRO250 System, includes DeWalt ® DCF622 screw gun fitted with adaptor, (Skin only)		707392013587	1 \$1,177.00
	DCF622NG2	DeWalt ® DCF622 screw gun (modified for Quik Drive) fitted with adaptor, (Skin only)		707392013594	1 \$702.00
*Screwgun not included, but required.					

Quik Drive® Screw Driving Systems

Image	Model No.	Description	Barcode	Pack Qty	Price/ Pack
Adaptors					
(Click here or see website for "Adaptor Fitting Instructions")					
		Model No. on adaptor			
	HIAG2	Hitachi® adaptor suits W6V3, W6VA3, W6VB3, W8VB2, W8V3	[201110] 746056022893	1	\$43.50
	MAA3G2	Makita® adaptor suits DFS250 (cordless Screwgun), FS2500, FS2300 (remove wire and circlips)	[201143] 746056665205	1	\$36.00
	MAA6807G2	Makita® adaptor suits 6807	[201129] 746056456667	1	\$41.00
Decking Accessories					
	PDECKNC-RC	Decking clip set for screw and space setting 3 mm and 5 mm (Suits PRO250 and PRO300 only)	746056254935	1	\$84.00
Replacement Parts					
	G2HANDLE	Extension replacement handle, G2 Series	746056010869	1	\$35.50
	PFEEDPAWL	Feed pawl, for PRO250, PRO300, PROPP150, PROPH attachments	746056058601	1	\$8.60
	PFEEDPAWLTL	Feed pawl, twist lock for PROHSD, SDS, PRO200 attachments	746056384755	1	\$8.60
Mandrels					
	PMANDREL65	Mandrel for PRO200, PROPH attachments	160 mm long 746056022923	1	\$31.50
	PMANDREL75	Mandrel for PRO250, PRO300, SDS, PROHSD attachments	190 mm long 746056022916	1	\$31.50
	NEW PMANDREL75-RC	Mandrel for PRO250, PRO300, SDS, PROHSD attachments (Retail hang card)	190 mm long 746056046042	1	\$36.00
	PMANDRELEXTG2	Mandrel for QDEXTG2 extension	515 mm long 746056434344	1	\$61.50
Driver Bits					
Packs of 10					
	BIT2S-RC10	#2 Square drive bit	707392665502	10	\$37.50
	BIT2SU-RC10	#2 Square undersize drive bit	707392872405	10	\$37.50
	BIT3S-RC10	#3 Square drive bit	707392903406	10	\$37.50
	BIT3SU-RC10	#3 Square undersize drive bit	707392762003	10	\$37.50
	BITTX20-RC10	T-20 6-lobe drive bit	746056122258	10	\$37.50
	BITTX25-RC10	T-25 6-lobe drive bit	746056612889	10	\$37.50
	BITTX30-RC10	T-25 6-lobe drive bit	707392014409	10	\$37.50
Extension					
	QDEXTG2	Extension, 515 mm, G2 series (Standard)	746056057529	1	\$210.00

Collated Screws for the Quik Drive® System 

Image	Model No.	Description	Barcode	Box Qty	Price/Box	Bulk Buy	Bulk Buy Price/Box			
Deck-Drive™ Premium Fasteners						Supplied with driver bit				
Hardwood										
DSD HARDWOOD Screw										
	DSDG50SA	12g x 50 mm	Quikguard® Grey	T-25	707392007708	1000	\$204.00	100	\$183.60	
	SSDSD50SA	12g x 50 mm	Flat countersinking head, Hardwood drill point	316 Stainless Steel	T-25	707392007678	1000	\$367.00	100	\$330.30
	SSDSD65SA	12g x 65 mm			T-25	707392007647	1000	\$453.00	100	\$407.70
	SSDSD1475SA *	14g x 75 mm		T-30	707392001331	750	\$518.00	100	\$466.20	
DHSD HARDWOOD Screw										
	SSDHSD50TSA	12g x 50 mm	Raised countersunk head, Hardwood Drill point,	316 Stainless Steel, T-20 6-lobe drive	707392010203	1000	\$368.00	100	\$331.20	
	SSDHSD60S	12g x 60 mm		305 Stainless Steel, #2 Sq. drive	746056675808	1000	\$448.00	100	\$403.20	
DHW HARDWOOD Screw										
	DHWG60SA	10g x 60 mm	Compact head, Winged, Hardwood drill point	Class 3 Galvanised, #2 Undersize sq. drive	707392207061	1000	\$209.00	100	\$188.10	
	SSDHW60SA	10g x 60 mm			305 Stainless Steel, #2 Sq. drive	707392450443	1000	\$453.00	100	\$407.70
Softwood										
DSV SOFTWOOD Screw										
	DSVT2S	10g x 50 mm	Rimmed flat head with nibs, Variable thread design, Quikguard® Tan. T-25 6-lobe drive	746056948308	1500	\$195.00	100	\$175.50		
	DSVT212S	10g x 65 mm		746056479802	1000	\$198.00	100	\$178.20		
	DSVT3S	10g x 75 mm		746056157205	1000	\$216.00	100	\$194.40		
Timber to Steel										
BFHSD BI-METAL Screw										
	SSBFHSD2SA	10g x 50 mm	Ribbed flat head, 16 TPI, #2 drill point, 316 Stainless Steel Bi-Metal, #2 Sq. Drive	746056751700	1000	\$583.00	100	\$524.70		
Winged Self Drilling Screws						Supplied with driver bit				
Cement Sheet / Underlay and Timber-to-Steel										
	CBSDG1SA	8g x 25 mm	Ribbed flat head, 18 TPI, #2 drill point, Class 3 Galvanised, #2 Undersize sq. drive	746056000303	2500	\$352.00	100	\$316.80		
	CBSDG114SA	8g x 32 mm		746056000204	1500	\$225.00	100	\$202.50		
	CBSDG158SA	8g x 42 mm		746056000105	1500	\$253.00	100	\$227.70		
	CBSDGL158SA	10g x 42 mm		746056214434	1500	\$301.00	100	\$270.90		
	CBSDGL214SA	10g x 55 mm		746056528906	1000	\$261.00	100	\$234.90		
	CBSDGL3SA	10g x 75 mm		707392945277	1000	\$292.00	100	\$262.80		
Compressed Cement Sheet-to-Steel										
	CBSDHG158SA	10g x 42 mm	Ribbed flat head, 16 TPI, #2 drill point, Class 3 Galvanised, #3 Sq. drive	746056186748	1500	\$300.00	100	\$270.00		
	CBSDHG214SA	10g x 55 mm		746056275305	1000	\$261.00	100	\$234.90		
Heavy Duty 14g Screws						*Suitable for use with the Quik Drive PROHSD				
	TBG1445SA	14g x 45 mm	Flat head w/nibs, 14 TPI, #4 drill point, Class 3 Galvanised, #3 Undersize sq. drive	746056154501	1000	\$315.00	—	—		
	TBG1460S	14g x 60 mm		746056003069	750	\$340.00	—	—		
	TBG1475S	14g x 75 mm		746056003076	750	\$375.00	—	—		

P-SS12U1 © 2021 SIMPSON STRONG-TIE COMPANY INC.

Collated Screws









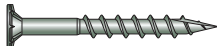

Collated Screws for the Quik Drive® System 

Image	Model No.	Description	Barcode	Box Qty	Price/Box	Bulk Buy	Bulk Buy Price/Box
Cement Sheet / Underlay Screws Supplied with driver bit							
	MTHG114SA	7g x 32 mm Trim head w/nibs, #2 Undersize sq. drive	707392352907	2500	\$143.00	100	\$128.70
	WSCBGHLA114SA	8g x 32 mm Wafer head w/nibs, #2 Undersize sq. drive	746056654803	2000	\$153.00	100	\$137.70
	WSCBGA158SA	8g x 42 mm Type 17, Class 3 Galvanised	746056897101	2000	\$179.00	100	\$161.10
Steel Subfloor Screw Supplied with driver bit							
	PPSD1050SA	10g x 50 mm Rimmed flat head w/nibs, 16 TPI, #2 drill point, Yellow Zinc, T-25 6-lobe drive	707392000440	2000	\$243.00	100	\$218.70
	 PPSDQ134S1016	10g x 45 mm Flat head, 16 TPI, #3 drill point, #3 Sq. drive	746056005520	2000	\$340.00	100	\$306.00
Flooring Screws Supplied with driver bit							
	WSC114SA	8g x 32 mm Flat head w/nibs, Type 17, Yellow zinc, #2 Sq. drive	746056423157	2500	\$153.00	100	\$137.70
	 WSV45SA	10g (4.8 mm) x 45 mm	707392014126	2000	\$162.00	100	\$145.80
	WSV50SA	10g (4.8 mm) x 50 mm	707392004622	2000	\$165.00	100	\$148.50
	WSV50-2500	Ribbed head, Aggressive variable thread, Sharp point, Yellow zinc.	707392007630	2500	\$198.00	100	\$178.20
	 WSV64SA	10g (4.8 mm) x 64 mm T-25 6-lobe drive	707392014133	1500	\$168.00	100	\$151.20
	WSV75SA	10g (4.8 mm) x 75 mm	707392014140	1000	\$156.00	100	\$140.40

P-SSTAU21 © 2021 SIMPSON STRONG-TIE COMPANY INC.

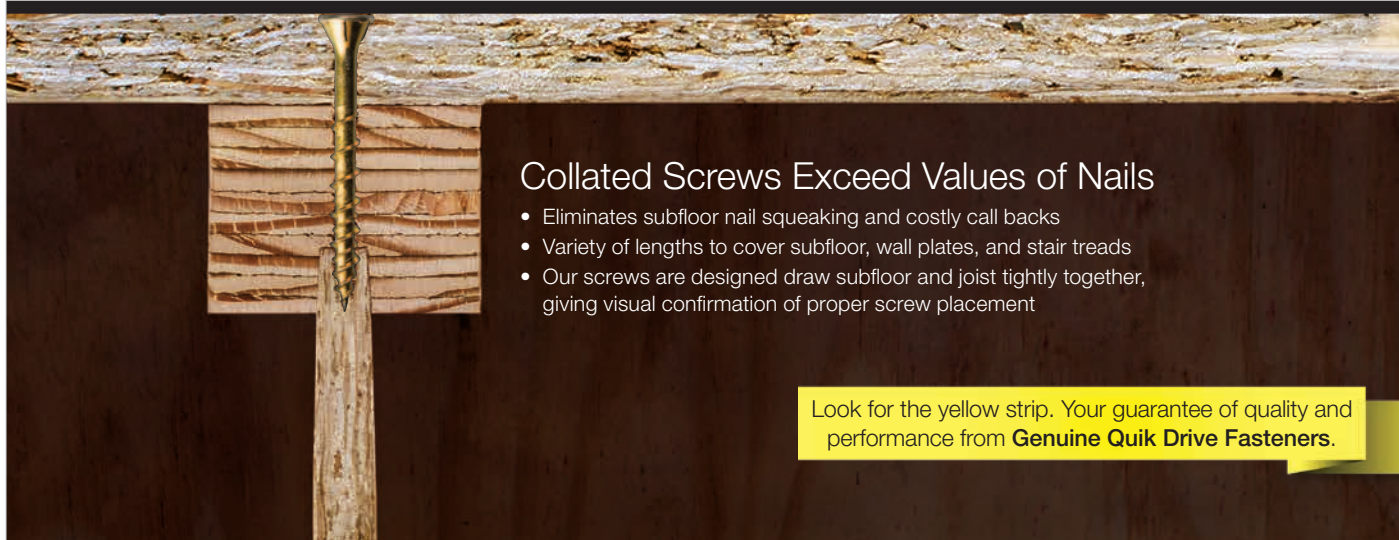

Collated Screws Exceed Values of Nails

- Eliminates subfloor nail squeaking and costly call backs
- Variety of lengths to cover subfloor, wall plates, and stair treads
- Our screws are designed draw subfloor and joist tightly together, giving visual confirmation of proper screw placement



Look for the yellow strip. Your guarantee of quality and performance from **Genuine Quik Drive Fasteners.**

Collated Screws

Anchoring Systems for Concrete and Masonry

Image	Model No.	Description	Size	Barcode	Box Qty	Price/ea	Bulk Buy	Bulk Buy Price/ea
-------	-----------	-------------	------	---------	---------	----------	----------	-------------------

Anchoring Adhesives

	SET-XP650-AU	High-performance epoxy anchoring adhesive for cracked and uncracked concrete <small>(Includes 2 mixing nozzles — EMN22i)</small>	650 ml	707392661399	10	\$65.00	600	\$58.50
	AT-HP300BLUE	Fast cure vinyl ester anchoring adhesive with colour change technology <small>(Includes 2 mixing nozzles — MN1)</small>	300 ml	707392009306	12	\$22.00	240	\$19.80

Adhesive Accessories





	EDT22S	Manual dispensing tool for 650 ml cartridges		707392239000	1	\$88.50	5	\$79.65
	DT300	Manual dispensing tool for 300 ml cartridges		3523140800707	1	\$36.00	12	\$32.40
	MN1-RP10	Mixing nozzle suits AT-HP™ Adhesives, Pack of 10		3523140628905	1	\$10.50	6	\$9.45

Image	Model No.	Description	Barcode	Box Qty	Ctn Qty	Price/100	Bulk Buy	Bulk Buy Price/100
-------	-----------	-------------	---------	---------	---------	-----------	----------	--------------------

Mechanical Anchors

Titen HD® Heavy Duty Screw Anchor for Concrete and Masonry

Mechanically Galvanised

	THD10060MG	M10	60 mm	5397062911104	50	200	\$138.00	1000	\$124.20
	THD10100MG		100 mm	5397062505402			\$196.00		\$176.40
	THD12075MG		75 mm	5397062531005			\$255.00		\$229.50
	THD12110MG	M12	110 mm	5397062506201	20	80	\$277.00	400	\$249.30
	THD12130MG		130 mm	5397062506409			\$307.00		\$276.30
	THD12150MG		150 mm	5397062506607			\$324.00		\$291.60
	THD16130MG	M16	130 mm	5397062506805	10	40	\$341.00	200	\$306.90
	THD16150MG		150 mm	5397062510000			\$371.00		\$333.90
	THD20150MG	M20	150 mm	5397062507109	5	20	\$699.00	100	\$629.10
	THD20170MG		170 mm	5397062507307		10	\$795.00		\$715.50

Titen Turbo™ Concrete and Masonry Screw Anchor

Drill bit sold separately see below

Hex Head — zinc plated with ceramic coating

	TNT25114H		32 mm	707392005117		1600	\$16.50	1600	\$14.85
	TNT25134H		45 mm	707392005131			\$18.00		\$16.20
	TNT25214H		57 mm	707392005155		500	\$21.00	500	\$18.90
	TNT25234H	6.5 mm	70 mm	707392005179	100		\$22.50		\$20.25
	TNT25314H		83 mm	707392005193			\$28.00		\$25.20
	TNT25334H		95 mm	707392005216		400	\$32.00	400	\$28.80
	TNT25400H		102 mm	707392005230			\$36.00		\$32.40

Countersunk Head — zinc plated with ceramic coating

Supplied with T-30 driver bit

	TNT25134TF		45 mm	707392005148			\$18.00		\$16.20
	TNT25214TF		57 mm	707392005162		500	\$21.00	500	\$18.90
	TNT25234TF	6.5 mm	70 mm	707392005186	100		\$22.50		\$20.25
	TNT25314TF		83 mm	707392005209			\$28.00		\$25.20
	TNT25334TF		95 mm	707392005223		400	\$32.00	400	\$28.80
	TNT25400TF		102 mm	707392005247			\$36.00		\$32.40

Image	Model No.	Description	Barcode	Pack Qty	Ctn Qty	Price/ea
-------	-----------	-------------	---------	----------	---------	----------

Titen® Concrete and Masonry Screw Drill Bit — Required for correct installation of Titen Turbo™

	MDB18512C1	3/16" x 5 1/2" (140mm), 100mm drilling depth. Concrete and Masonry Drill Bit (Carded Single)	707392797951	1	10	\$6.50
	MDPLO1806	3/16" x 6 1/4" (159mm), 100mm drilling depth. SDS-plus® Shank, 2-Cutter Head, Masonry Drill Bit	707392514800	1	200	\$8.00
	MDPLO1808	3/16" x 8 1/4" (210mm), 150mm drilling depth. SDS-plus® Shank, 2-Cutter Head, Masonry Drill Bit	707392104407	1	125	\$10.50

P-SSSTA121 © 2021 SIMPSON STRONG-TIE COMPANY INC.

Anchoring Systems for Concrete and Masonry

Image	Model No.	Description	Size	Barcode	Box Qty	Price/ea	Bulk Buy	Bulk Buy Price/ea
Powder-Actuated Fastening Systems								
Semi-Automatic Tool								
	PT-27	Strip feed and manual cycle .27 caliber tool includes accessories and carry case	16 – 72 mm pins	707392649809	1	\$525.00	6	\$472.50





PAT Application Guide

General Notes

1. Average pin embedment into concrete is 19–32 mm.
2. To determine pin length for concrete: add fixture thickness and embedment depths.
3. To determine pin length for steel applications: add fixture thickness plus steel thickness plus 3 mm. Getting the point to pass through steel 3 mm maximises holding strength.
4. When selecting a load power level, it is recommended to make a test fastening with the lowest power level. If the powder load does not set the fastener, try the next highest load, and so on, until the fastener is properly set.

For fastening →	Timber (45 mm thick)	Timber (25 mm thick)	Plywood (19 mm thick)	Steel Fixtures/Conduit Clips (light steel)	Drywall Track
Concrete	72	52	42	27	19
Cement Block	72	52	42	27	27
Steel (5–6 mm)	62	32 (washed)	32 (washed)	19	16 (knurled)
Steel (6–8 mm)	62	42 (washed)	32 (washed)	19	16 (knurled)

1. To be used as a guide only—see General Notes
2. Recommended minimum embedment depth for maximum holding strength: Steel = 12 mm; Concrete/Cement Block = 25 mm

Image	Model No.	Description	Size	Barcode	Box Qty	Price/100	Bulk Buy	Bulk Buy Price/100
Powder Loads								
.27 Caliber plastic strip loads — 10 per strip								
	P27SL2	Brown (Level 2) suits auto and semi tools	.27 Cal	707392577515	100	\$20.15	5000	\$18.14
	P27SL3	Green (Level 3) suits auto and semi tools		707392642015		\$20.15		\$18.14
	P27SL4	Yellow (Level 4) suits auto and semi tools		707392983019		\$20.15		\$18.14
	P27SL5	Red (Level 5) suits auto and semi tools		707392932611		\$20.15		\$18.14
Fasteners								
Loose Drive Pins								
	PDPA-75		19 mm	707392470519	100	\$10.80	1000	\$9.72
	PDPA-100	Head: 7.6 mm	27 mm	707392818823		\$11.50		\$10.35
	PDPA-125	Shank Diameter: 3.98 mm	32 mm	707392810520		\$12.00		\$10.80
	PDPA-150	Tip: Ballistic point	37 mm	707392373124		\$13.60		\$12.24
	PDPA-187	Finish: Zinc coated	47 mm	707392143420		\$15.50		\$13.95
	PDPA-200MG	Head: 7.6 mm	52 mm	707392556800		\$17.00		\$15.30
	PDPA-250MG	Shank Diameter: 3.98 mm	62 mm	707392392804		\$19.80		\$17.82
	PDPA-287MG	Tip: Ballistic point	72 mm	707392512202		\$20.80		\$18.72
Loose Washered Pins								
	PDPAWL-100		27 mm	707392460015	100	\$26.50	1000	\$23.85
	PDPAWL-125	Head: 7.6 mm	32 mm	707392530015		\$27.50		\$24.75
	PDPAWL-187	Shank Diameter: 3.98 mm	47 mm	707392329022		\$28.00		\$25.20
	PDPAWL-200	Washer: 24 mm	52 mm	707392708810		\$29.00		\$26.10
	PDPAWL-250	Tip: Ballistic point	62 mm	707392739210		\$31.00		\$27.90
	PDPAWL-287	Finish: Zinc coated	72 mm	707392653813		\$36.00		\$32.40

P-SSTAU21 © 2021 SIMPSON STRONG-TIE COMPANY INC.

Anchoring Systems



Every day we work hard to earn your business, blending the talents of our people with the quality of our products and services to exceed your expectations. This is our pledge to you.

Simpson Strong-Tie® Australia Pty. Limited

ABN: 590 8888 3863

Call **1300 STRONGTIE** | strongtie.com.au

Email orders to sales.au@strongtie.com